



Shore-Side Electricity

Guidance to Port Authorities and Administrations

Part 1 – Equipment and Technology

Version 1
June 2022

Cover Image:
Courtesy **Port of Hamburg**

DISCLAIMER

The EMSA Guidance on Shore-Side Electricity to Port Authorities/Administrations is an open document, aiming to incorporate and keep up with industry practice development, including technology elements. Comments, suggested modifications, additions, or possible corrections are welcomed via EMSA webmail: Information@emsa.europa.eu.

None of the provisions within the EMSA Guidance are binding in nature and should be regarded as guidance for good practice. Adequate application of the provisions within the EMSA Guidance should always be done in conjunction with the reference industry standards and published good practice on electrical energy supply to ships.

Acknowledgements

The EMSA Guidance on Shore-Side Electricity for Port Authorities and Administrations was the result of a vote of confidence from the Sustainable Ports Subgroups of the European Ports Forum, and the active contribution from several stakeholders throughout its development. EMSA would like to acknowledge the Forum and its Subgroup for giving the Agency the objective, goal, and continuous support in the development of this guidance document.

Particularly, EMSA would like to acknowledge the support and contribution from:

- European Sea Ports Organization (ESPO) and all its members
- National Technical University of Athens (NTUA), in particular to Professor John Prousalidis
- International Association of Classification Societies (IACS)
- American Bureau of Shipping (ABS)
- Det Norske Veritas (DNV)
- EURELECTRIC
- CINEA, for the important institutional cooperation and sharing of results/ deliverables from EU co-funded SSE/OPS projects
- EALING project
- European Community Shipowners' Association (ECSA)
- Cruise Lines International Association (CLIA)
- Hapag Lloyd
- ABB
- Holland America

Table of Contents

PART 1

Acknowledgements	2
Table of Contents	3
List of Abbreviations and Acronyms in Part 1	4
Foreword	6
Introduction	7
Guidance Map	9
SSE in a Nutshell	10
Shore-side electricity options	10
Opportunities & challenges	11
EU Context	13
1. Scope, applicability & definitions	14
1.1 Applicability	14
1.2 Objectives	15
1.3 Exclusions and limitations	15
1.4 SSE from planning through operation.....	16
1.5 Terms & definitions	17
2. SSE General block architecture	19
3. SSE – General infrastructure and equipment	23
3.1 Power source	23
3.2 Transmission and distribution cable lines	56
3.3 Protection systems	66
3.4 Substations	67
3.5 Switchboards.....	76
3.6 Circuit breakers	81
3.7 Transformers.....	98
3.8 Inverters/rectifiers.....	110
3.9 Frequency conversion.....	112
3.10 Energy storage systems	128
3.11 Ship-shore connection equipment	143
References for Part 1	165
Links for figures in Part 1	167

List of Abbreviations and Acronyms in Part 1

ALARP	As Low as Reasonably Possible
CCNR	Central Commission for Navigation in the Rhine
DWT	Deadweight tonnage
EAFO	European Alternative Fuels Observatory
EAM	Emission Abatement Method
EC	European Commission
ECA	Emission Control Area
EMCIP	European Maritime Casualties Information Platform
EMSA	European Maritime Safety Agency
EPR	Emergency, Preparedness & Response
ERC	Emergency Release Couplings
ERS	Emergency Release System
ESD	Emergency Shutdown System
EU	European Union
FMEA	Failure Modes and Effects Analysis
GT	Gross Tonnage
HAZID	Hazard Identification
HAZOP	Hazard & Operability Study
HSE	Health & Safety Executive
HVSC	High Voltage Shore Connection
IACS	International Association of Classification Societies
IAPH	International Association of Ports and Harbours
IEC	International Electrotechnical Commission
IEEE	Institute of Electrical and Electronics Engineers
IMO	International Maritime Organization
ISO	International Standardisation Organization
LVSC	Low Voltage Shore Connection
MARPOL	International Convention for the Prevention of Pollution from Ships
MGO	Marine Gasoil
NO_x	Nitrous Oxides
OPS	Onshore Power Supply
PAA	Port Authorities & Administrations (used throughout the document for simplification in the text)
PLC	Programmable Logic Controller
PPE	Personal Protective Equipment
PSC	Port State Control
PSCO	Port State Control Officer
QRA	Quantitative Risk Assessment
QualRA	Qualitative Risk Assessment

RA	Risk Assessment
RO	Recognised Organisation
SBC	Shore-side Battery Charging
SECA	Sulphur Emission Control Areas
SoC	Statement of Compliance
SO_x	Sulphur Oxides
SPB	Shore-side Power Bank
SSL	Ship Shore Link
STCW	IMO Code for Seafarers' Training, Certification and Watchkeeping
SWIFT	Structured What-If Checklist (SWIFT) technique
UNECE	United Nations Economic Commission for Europe
WPCI	World Ports Climate Initiative

Foreword

The European Maritime Safety Agency (EMSA) has been established under Regulation (EC) 1406/2002 (as amended) of the European Parliament and of the Council for the purpose of ensuring a high, uniform, and effective level of maritime safety, maritime security, prevention of and response to pollution caused by ships as well as response to marine pollution caused by oil and gas installations.

Articles 1 and 2 (d) of the amended founding regulation foresee that the Agency shall assist the Commission in the performance of tasks assigned in legislative acts of the Union, including the ones in the field of prevention of pollution caused by ships. To that end, EMSA works on the development of elements to support the implementation and uniform enforcement of Directive 2014/94/EU on the deployment of an alternative fuels' infrastructure. This Guidance is part of this support considering Shore-Side Electricity (SSE) as an alternative energy technology and is complementary to other reference documents (rules, standards, and other guidance documents).

The Guidance, divided into two Parts, is intended to assist primarily port authorities and administrations in the planning and development of SSE options, starting with project decision-making and development of infrastructure elements, definition of responsibility frameworks and construction of control measures to assist in operation.

Ports are developing into technological ecosystems standing in the interface of several maritime and landside/hinterland dimensions. Energy sustainability and efficiency, safety, operations, and digitalization are becoming concepts increasingly explored by ports. SSE is an important "piece of the puzzle" that will be present in the portfolio of energy services provided to ships at berth.

Shore-side electricity encompasses, in the context of the present Guidance, the several dimensions of electrification in the ship-shore interface. SSE includes different configurations, being Onshore Power Supply (OPS) the option where more experience has been gained. OPS is a standardised process where most ship types, across a large power demand range, are covered. Interoperability and interconnectivity in OPS are largely included in existing standards. Thanks to the experience gained, the OPS reached a stage of maturity at technical and operational level as an alternative power option for ships at berth.

In addition, the Guidance also covers other uses of electrical energy in the shore side interface. Battery charging, energy storage applications, such as power banking, and microgeneration are also included, even if their expression is still reduced in comparison to OPS. Attention to these SSE options is, however, likely to increase as more electric/hybrid ships enter into service.

Despite the already existing experience with OPS at global level, it was only in 2020 that the safety/standardisation framework for OPS was consolidated. This was, for the past years, an essential focus at international level: to develop the safety, technical and operational framework that could support a level playing field at international level.

In close cooperation and consultation with the Sustainable Ports expert subgroup, of the European Ports Forum (EPF), with the European Sustainable Shipping Forum (ESSF), and with early movers on OPS, EMSA consolidates in this Guidance information intended to support Port Authorities and Administrations (PAA) on SSE.

The Guidance does not intend to overlap with existing requirements or industry guidance. The value proposition of the EMSA Guidance on SSE for Port Authorities and Administrations is to provide ports with a toolkit for decision-making for the entire life-cycle of shore-side electricity projects, from planning to operation. In addition, it can be used for consultation by all stakeholders which may be involved in the project, implementation, and operation of SSE in ports.

An important element to note is that the guide itself is not considering whether SSE should be used, but rather focuses on providing guidance on implementation once the decision to use SSE has been made.

Introduction

Onshore Power Supply (OPS), also commonly referred to as Alternate Marine Power (AMP) or *Cold Ironing*, represents an alternative power option for ships at berth which, by allowing onboard generators to be stopped, reduces the emissions.

Other options for electrification in the ship-shore interface include battery charging, electrical energy storage/power banking and microgeneration. Together with OPS these are all covered in the present Guidance under the concept of Shore-Side Electricity (SSE).

The primary objective for OPS, the Shore-Side Electricity option with more applications, until very recently, has been focused on the improvement of port local air quality through reduction of ship-sourced pollutants such as NO_x, SO_x, PM or other substances associated to onboard combustions processes. The reduction of CO₂ emitted from ships at berth would also be a relevant result, particularly if the electricity mix supplied is mostly sourced from blue/green electrical production sources (biomass, hydro, or renewables).

To the primary environmental performance objectives there are other factors which contribute today to OPS as a sustainable energy technology for ships at berth. The evolution of ports from conventional networks to *smart grids*; the societal added value of technology and digitalization; noise reduction both in the port area and onboard; competitive advantage towards sustainable shipping and ports, as a response to future challenges. Adequate valuation of all costs and benefits for SSE is fundamental for evaluation of its feasibility. A multi-dimensional/multi-objective approach is needed to address SSE projects.

In 2012 the Ministry of Transport of China set a technical code (JTS155-12) stating that OPS should be included in the design and construction of new container, bulk, cruise, and RO-Pax terminals. In 2014, the European Directive 2014/94/EU on the Deployment of Alternative Fuel Infrastructure (AFID Directive) established the requirement for European ports to progressively equip their berths with shore connection to have all ports equipped by 2025, establishing, however, a cost-benefit pre-condition. Shore connection has been included in Californian regulation (CARB). Since 2020, in selected Californian ports, 80% of the source of vessels power must come from OPS. Several countries have implemented funding programs for developing SSE in ports, such as Canada (Shore Power Technology for Ports program-SPTP) and in Europe through the Connecting Europe Facility fund. In addition to the developing regulatory scheme, and in the context of incentives for OPS development, tax reduction on electricity used by vessels can be applied by European countries as per Directive 2003/96/EC.

At EU level, as mentioned above, SSE is part of the Alternative Fuel Infrastructure which needs to be deployed in EU Core ports by the end of 2025 according to Directive 2014/94/EU. Article 4.5 of the directive requires EU Member States to *ensure that the need for shore-side electricity supply for inland waterway vessels and seagoing ships in maritime and inland ports is assessed in their national policy frameworks*. The same article stated that such shore-side electricity supply *shall be installed as a priority in ports of the TEN-T Core Network, and in other ports, by 31 December 2025, unless there is no demand and the costs are disproportionate to the benefits, including environmental benefits*.

More recently, the “Fit for 55” EU legislative package proposal¹, published in July 2021, under the EU Green Deal, includes proposals relevant to the promotion and deployment of Shore-Side Electricity (SSE). The Alternative Fuels Infrastructure Regulation (AFIR) is proposed as a revision of Directive 2014/94, including now **mandatory requirements for ports to have in place OPS infrastructure to supply passenger ships and containerships of gross tonnage above 5,000 GT, as of 1 January 2030**. Specific thresholds are defined for the number of calls above which ports are required to implement the infrastructure across all EU TEN-T network. On the demand side, the FuelEU Maritime regulation includes specific provisions that will also promote the use of OPS in ports by the same ships, by requiring them to be zero-emissions at berth as from 1 January 2030.

The recent publication of IEC/IEEE 80005 *Utility connections in port series*, particularly of Part 1: *High voltage shore connection (HVSC) systems – General requirements*, in March 2019, together with the agreement of a text for the IMO OPS Guidelines² in March 2020, can be considered as two important steps towards the edification of a formal structure for technical and operational requirements for OPS.

¹ https://ec.europa.eu/commission/presscorner/detail/en/IP_21_3541

² IMO Draft Interim Guidelines on Safe Operation of Onshore Power Supply (OPS) Service in Port for Ships Engaged on International Voyages, with a final text agreed at the 7th Session of the Sub-Committee on Ship Systems and Equipment (SSE7), at IMO.

The standardisation of both technical and operational aspects requires, however, that all relevant stakeholders are addressed, which implies, to the very least, being given the necessary elements to enable an informed participation during the planning, certification, operation, safety assessment or even emergency response. Ports are, in this context, a fundamental player in all stages of any SSE project. With specific project details, hazards, of electrical nature or other, SSE systems need a properly shaped response, based on harmonised procedures that minimise barriers at the ship-shore interface. It is therefore important to address port authorities and administrations and other players in the context of an increasing SSE deployment in ports, both in the potential roles of developers/operators and promoters of SSE projects. Partly covered by the IMO Guidelines on OPS, the role of ports is still largely open for improvement, in a context of expanding SSE as a service for multi-point supply, to different ships, instead of tailor-made customized solutions. This is true not only at technical level, for systems compatibility/connectivity but also at operational/procedures level.

Ports are, in the present context, assisted by a good number of technical and standardisation references, but there is still a certain amount of uncertainty with respect to the regulatory framework and administrative burden associated to the development of SSE.

The EMSA Guidance on SSE is presented as an instrument to support ports in their role of assessing, supporting, evaluating, and developing control measures for the development of Shore-Side Electricity (SSE) to ships engaged in international voyages, domestic shipping routes and inland waterways. It is intended as complementary to the existing framework, both **IEC/IEEE 80005 series** and **IMO Interim Guidelines on OPS** to Ships Engaged in International Voyages.

Apart from OPS, also Shore-side Battery Charging (SBC) and Shore-side Power Banks (SPB) are addressed by this EMSA Guidance on SSE. These are options with strong potential for growth in the near future of which there are already some example applications deployed for specific services. Despite not having yet sufficient available experience from the maritime sector in terms of SBC/SPB, these were included, on one hand for information, on the other hand to highlight the need to carefully consider the risks associated, specifically, to battery charging and to battery systems of liquid electrolyte (in particular to lithium-ion).

The EMSA Guidance on SSE to PAA is structured in 2 Parts as presented in the following Guidance Map.

Guidance Map

The present Guidance document is **Part 1** of a **2-document set** presented below:

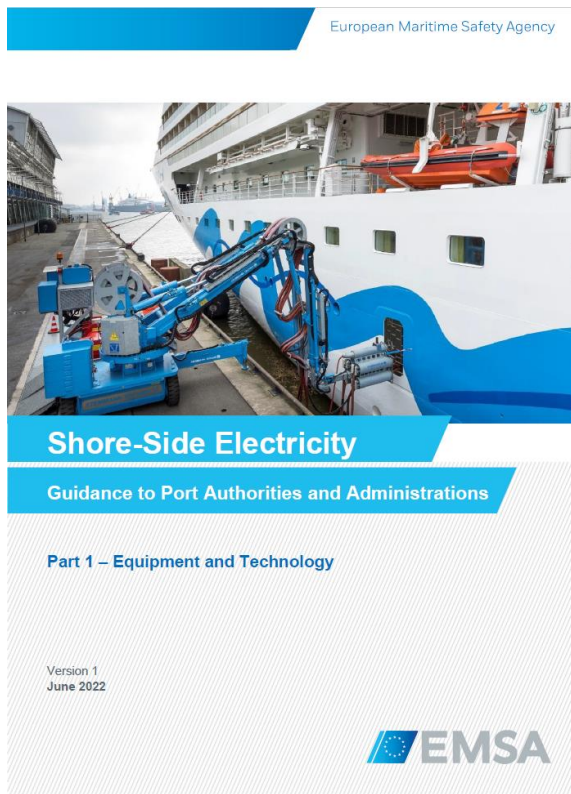

Part 1 – Equipment and Technology

Objective:

Introduction and overview of equipment and technologies available for shore-side electricity infrastructure projects.

Contents:

- Identification of the main equipment and structural elements of shore-side electricity.
- Details of the working principles and relevance of different equipment in the context of SSE Installations.

The following Sections are included:

1. Scope, Applicability & definitions
2. Shore-Side Electricity elements – General Introduction
3. SSE Infrastructure and Equipment
 - a. Power source
 - b. Transmission and distribution cable lines
 - c. Protection systems
 - d. Substations
 - e. Switchboards
 - f. Circuit breakers
 - g. Transformers
 - h. Inverters/rectifiers
 - i. Frequency conversion
 - j. Energy storage systems
 - k. Ship-shore connection equipment

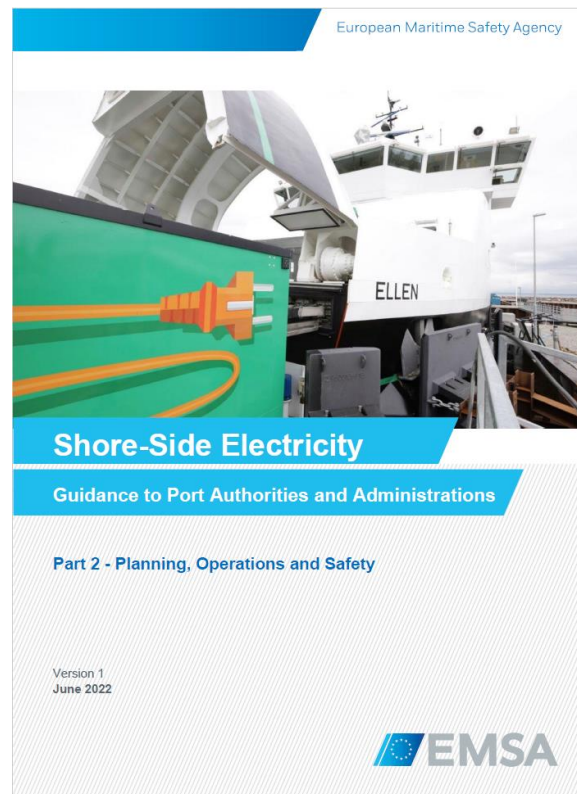

Part 2 - Planning, Operations and Safety

Objective:

Support to project, implementation, and operation of SSE facilities.

Contents:

- Planning and project development elements for shore-side electricity
- Operational and safety aspects, including detailed OPS and battery charging aspects.

The following Sections are included:

4. Shore-Side Electricity Options
5. Regulatory Framework
6. Responsibilities
7. Project and Feasibility
8. Operation
9. Safety

SSE in a Nutshell

Shore-side electricity options

Despite being all different forms of electricity supply to ships, OPS, SBC and SPB present very different technological options and stages of maturity. Whilst OPS operation has already gained decades of experience, particularly with low-voltage supply, shore-side battery charging/battery swapping or power banks are still a developing technological option, recently favoured by the increase in the adoption of electric/hybrid options for powering ships. Below, selected highlights are presented for the different forms of supplying electricity to ships at berth.

Onshore Power Supply (OPS)

- Key technology to mitigate ship's emissions at berth.
- Availability of OPS is increasing as part of ports sustainability initiatives.
- Supply of high voltage electricity is a key enabler for OPS of higher power demanding ships.
- OPS projects require involvement from many stakeholders.
- Architecture of OPS systems is increasingly automated to allow for efficient operation.

- More ports are today offering OPS services, allowing ships to reduce emissions at berth, with benefits for local air quality, reduction of GHG emissions and noise.
- Ships at berth have significantly different operating profiles, imposing different requirements for power supply.
- High voltage supply (>1 kV AC) enables more efficient connection.
- Matching AC frequency 50/60 Hz is an aspect to consider for transoceanic ships.
- Standardisation achieved by complete IEC/IEEE 8005 series.
- IMO Interim Guidelines for Safe OPS operation have been finalised.

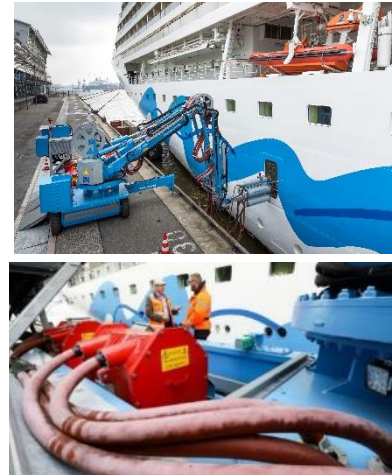

Source: German News Agency

Shore-side Battery Charging (SBC)

- Shore-side battery charging has developed at the pace of increasing numbers in hybrid/electric ships
- Charging from port-side infrastructure, through onshore transformers, is key.

- Growing number of electric/hybrid ships has driven the development of shore-side battery charging options, typically automated and associated with dedicated mooring systems.
- SBC with shore-side transformer saves significant space onboard the receiving ship.
- Typical specification in the order of multi-MWh charger for fast charging during short periods at berth.



Source: Cavotec SA

SBC Battery Swapping (SBC-BS)

- Battery swapping may allow electric/plug-in vessels to have reduced turnaround times at berth, without having to "wait-to-charge".
- Modularity and standardisation are key aspects to ensure.

- Battery swapping provide for flexibility, reduced charging periods at berth and operational gains for waterborne trade in fixed routes.
- High demand for standardised solutions and to mitigate the risk of multiple proprietary solutions.
- Ship-shore interface infrastructure to be designed for swift and safe handling of battery module units.



Source: Wärtsilä Corporation

Shore-side Power Banks (SPB)

- Power banks, or shore side Electrical Energy Storage (ESS) units are technology enablers for the storage of on-site renewable electricity.
- Batteries are the central technology in power bank stations.

- Power banks are used currently in many applications, for temporary storage of renewable electricity production.
- Important technology enabler for implementation of solar/wind projects in the port area.
- Current battery technology has low energy density, leading to a large footprint area per installed MWh energy unit.



Source: Stena Line

Port generators

- Electricity supply where SSE infrastructure is not yet in place can be provided by port generators.
- For actual environmental gains, electricity production should be based on cleaners low-to-zero carbon fuels.

- Port Generators may be shore or waterborne, either in containerized units or power barge units.
- Solution already deployed and implemented in practical commercial applications.
- Allows for flexibility, with electricity production possible in different port locations.
- Actual environmental benefits depend on fuel used for power generation.



Source: Becker Marine Systems

Opportunities & challenges

The main advantages and challenges for the use of each of the SSE supply alternatives introduced before are summarized in the following tables.

Table i: OPS for shipping in a nutshell - advantages/opportunities and challenges.

Advantages/opportunities	Challenges
<ul style="list-style-type: none"> - Environment: local impact from OPS is immediately positive in terms of SO_x, NO_x and Particulate Matter (PM) emissions. GHG impact would depend on the specific CO₂ emission factor associated to the available electricity supply. - Noise reduction: with connection to energy from the shore there would be no need to have the auxiliary engines running, leading to an immediate noise reduction onboard and in the port area. - Working conditions: significantly improved working conditions, allowing for a more comfortable working environment onboard. - IMO Guidelines for OPS: having been finalised in SSE sub-committee in 2020, the IMO Interim Guidelines for safe OPS operation, once published, will constitute a global-reaching instrument for the development of shore-side electricity. 	<ul style="list-style-type: none"> - GHG impact: in countries with high CO₂ emission factors for the electricity supply, the use of SSE from the national electricity grid would lead to more emissions than using the standard diesel generator on-board. - Frequency: the incompatibility 50/60 Hz would have to be resolved by the installation of a frequency converter. This would immediately lead to an increase in the investment cost associated to SSE infrastructure. - Connectors: standardisation of OPS equipment can be a challenge, at global level. Through Directive 2014/94 the standard enforce is IEC/IEEE 80051/1 (2019) – High Voltage Shore Connection (HVSC). - Black-out: some onboard shore-power arrangements in the main switchboard may lead to black-out during transfer of the energy from ship to shore supply. Gradually, with the introduction of synchronization capability this challenge has been overcome.

Table ii: SBC for shipping in a nutshell - advantages/opportunities and challenges.

Advantages/opportunities	Challenges
<ul style="list-style-type: none"> - Growing hybrid/electric ships fleet: with the growing installed power deployment on all-electric/hybrid-electric ships is increasing leading to a necessary development of SBC. - Efficiency: shore-side battery charging, depending on the interface connection, can be done from the moment the ship arrives at berth with minimum-to-zero human interference. - Operation: the possibility to fast charge is currently driving the energy supply for battery charging at High Voltage DC (2MW at 1kV DC). There is a high operational advantage for hybrid/electric ships requiring for fast charging or “energy snacking”. - Ship design: having transformers ashore instead of onboard allows for increased flexibility in internal arrangement onboard. This is particularly relevant for all-electric ships where the internal space is significantly taken by battery rooms. 	<ul style="list-style-type: none"> - GHG impact: as with OPS, CO₂ emissions of electricity are dependent on local electricity mix. - Safety: battery charging, particularly of Lithium-ion (Li-ion) battery charging is associated to specific fire hazards, especially in the case of battery thermal runaway, resulting for overcharging, short-circuit or any other related electrical fault. - Connectivity: battery management system onboard will need to communicate essential elements with the shore-side charger. Firstly, the state-of-charge needs to be shared, but many other parameters need to be exchanged to ensure safe and efficient operation. - Customisation: all SBC systems currently deployed are tailor-made, highly customised. It is important to foresee a future where multiple ships may be served by the same battery charger. - Standardisation: there is no standard for shore-side battery connection.

Table iii - SPB for shipping in a nutshell - advantages/opportunities and challenges.

Advantages/opportunities	Challenges
<ul style="list-style-type: none"> - Renewable energy sources: growing deployment of renewable energy sources in the port area will drive the need for energy storage systems, mostly battery based, such as power banks. - Efficiency: power banks allow for “energy snacking” where partial amounts of energy are power-charged/fast-charged onto onboard batteries. - Port operations: other services in the port area may be presented as potential customers for power bank energy. - Technology: current battery technology, in particular flow batteries, are promising for stationary applications. - Flexibility: containerised energy storage units can be deployed anywhere and moved around the port area to supply renewable electricity on-the-spot 	<ul style="list-style-type: none"> - Maintenance: large numbers of containerised battery units in the port area (typically a hazardous area, with moving elements, moving cargo and complex interoperability). - Safety: battery charging, particularly of Lithium-ion (Li-ion) battery charging is associated to specific fire hazards, especially in the case of battery thermal runaway, resulting for overcharging, short-circuit or any other related electrical fault. - Low energy density: containerised energy power banks, due to low energy density of batteries, would require many units per MWh. - Large footprint. Large area of implementation, per MWh, may be critical on a port area, or specific terminal, where the value of square meter may be very high.

EU Context

In 2005 the ENTEC Study for the European Commission (DG-ENV) [1] resulted in a characterization of OPS as an important emission abatement method. Technical aspects and business case elements were presented in that study, building on earlier experience with SSE technology and focusing strongly on the high potential of the use of SSE in the improvement of local air quality in ports and, in association, improvement of life quality in the cities and areas surrounding ports. Shortly after, in 2006, a Commission recommendation [2] was published identifying the relevance of specific technical elements on SSE and associated costs. In that recommendation, the Commission outlines that *Member States should consider the installation of shore-side electricity for use by ships at berth in ports; particularly in ports where air quality limit values are exceeded or where public concern is expressed about high levels of noise pollution, and especially in berths situated near residential areas. They should also report to the Commission on actions they intend to take to reduce ship emissions in ports in these areas. The development of harmonized international standards for shore-side electrical connections is recommended.* [2]

Today, SSE in the EU context is characterized by a combination of work from 4 fundamental standpoints that are together in the development of an SSE framework for both international shipping and inland waterways:

1. **Legislative framework**, with Directive 2014/94/EC, part of the EU Clean Power for Transport package, setting 31 December 2025 as the limit date for SSE infrastructure deployment on both sea and inland waterway ports [3]. Regulation 2017/352 establishing a framework for the provision of port services and common rules on the financial transparency of ports [4], treating the provision of OPS as part of the bunkering services. More recently, the Alternative Fuels Infrastructure Regulation (AFIR) proposing as a revision of Directive 2014/94, including now mandatory requirements for ports to have in place OPS infrastructure to supply passenger ships and containerships of gross tonnage above 5,000 GT, as of 1 January 2030. On the demand side, the FuelEU Maritime regulation including specific provisions that will also promote the use of OPS in ports by the same ships, by requiring them to be zero-emissions at berth as from 1 January 2030.
2. **Co-funding programs** such as Connecting Europe Facility (CEF), Horizon 2020, earlier Framework Programs, and others, which have included due consideration for the relevance of projects for SSE or hybrid/electric ships. Support in capital investment, improvement of OPS projects feasibility and allowing for positive return on investment of projects that gained favourably from sharing the investment risk within a context of EU co-financing support.
3. **Standardisation**, where, through different initiatives, an important effort in the development of standards has been put in place, for both seagoing ships and inland waterway vessels, with a view for compatibility and interoperability of SSE in the ship-shore interface, contributing in this way to safety of operations. At the same time, standardisation allows for a reassurance in the adoption of OPS. Part 2 Section 5 of the present Guidance provides an overview of the standards relevant to SSE.
4. **Private industry initiative**, developing different projects particularly focused on ship-specific/company-specific arrangements for shore-side electricity supply typically in specific dedicated terminals. This has been the case with domestic passenger ships and small ferries. Customised solutions, where the selected SSE systems are developed and tailor-made for specific vessels demand and operating profile, allow a business case to be explored with less risks and uncertainties. Nevertheless, more and more non-dedicated SSE services are expected to be deployed in the future.

EU SSE infrastructure has openly developed in the last years. The European Alternative Fuels Observatory (EAFO) regularly updates a database with information on the OPS systems available at different EU Ports.³

³ OPS data by EAFO: <https://www.eafo.eu/shipping-transport/port-infrastructure/ops/data>

1. Scope, applicability & definitions

This Guidance provides a set of good practice control measures for Onshore Power Supply (OPS), including Shore-side Battery Charging (SBC) and Shore-side Power Banks (SPB), relevant to port authorities/administrations in their role on permitting, evaluating, approving, certifying, controlling, overviewing, documenting, and providing/coordinating response in case of emergency.

1.1 Applicability

The EMSA Guidance applies to Port Authorities/Administrations (PAA) in EU ports when involved in Shore-Side Electricity (SSE) deployment at any point of the life cycle of such project (planning, commissioning, operation, maintenance) within their areas of port jurisdiction, including:

1. Onshore Power Supply (OPS), in High or Low Voltage (HV/LV), centralized or de-centralized concepts,
2. Shore-side Battery Charging (SBC),
3. Shore-side Power Banks (SPB) and
4. Electricity production in the port area, for the purpose of shore-side energy supply to ships.

This Guidance is applicable in a complimentary way to existing standards, guidelines, and industry good practice instruments.

The EMSA Guidance does not apply to the ship side nor to the upstream energy supply, outside port reception interface. It is nevertheless important to be mindful of the applicable regulatory framework for the ship side as it is a key objective of the present document to facilitate harmonization of procedures in the ship-shore interface.

In general terms, the scope of applicability of the present Guidance is indicated in Figure 1.1.

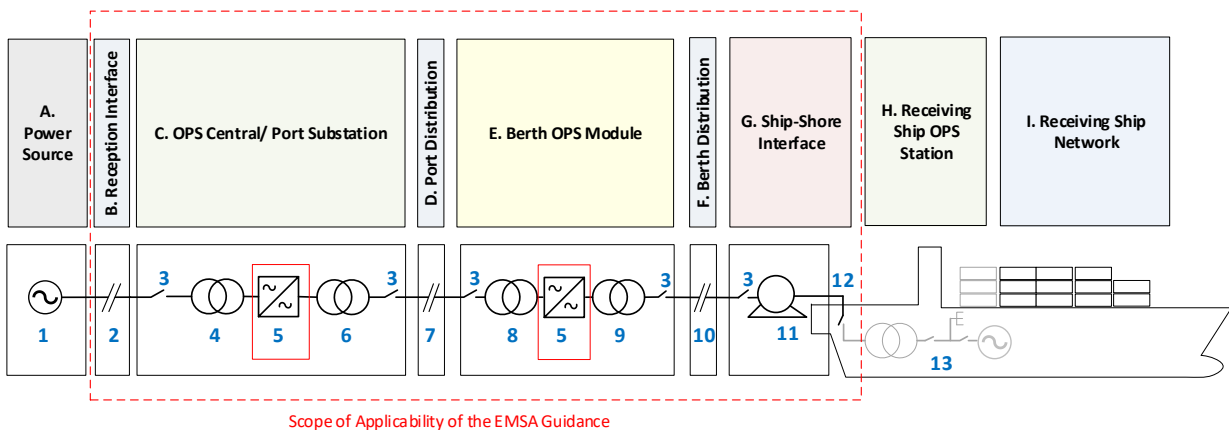

Figure 1.1 - Scope and Applicability of the EMSA Guidance on SSE to Port Authorities and Administrations.

Source: EMSA

The architecture of SSE systems is highly port-specific, and the current Guidance applies to generic system layouts, focusing on the framework for engineering feasibility, regulatory and standardisation references, proposal of best practices for organization for operation, documented evidence of compatibility and certification, amongst other important aspects for ports and for ship-shore operation management.

The Guidance applies irrespective of fundamental choices typically made on SSE projects, including but not limited to:

- Project development initiative (public/private/shared) responsibilities.
- SSE infrastructure ownership (port, terminal or ship owned) – partial ownership or shared ownerships are also possible arrangements.
- Electricity supply (direct supply, port/terminal buy & supply, port/terminal generate & supply).

1.2 Objectives

The objectives defined for the EMSA Guidance on OPS are to assist port authorities/administrations with:

- Elements to develop procedure for the evaluation, control, and through-life assessment of OPS, focusing primarily on the safety of ship-shore interface.
- Identification of the key regulatory framework for SSE, listing the standards for compatibility and interconnectivity of SSE.
- *Good Practice* proposals targeting typical barriers to be overcome/addressed when assessing the feasibility of SSE.
- Identification of potential gaps in standardisation.
- Definition of a unified set of first principles for permitting and approval, including a common risk assessment evaluation approach for the adequate consideration of HVSC and LVSC specific risks, including battery charging and shore-side energy storage.
- Proposal for implementation of harmonized OPS procedures in EU ports to mitigate the risk of different shore-side and interface procedures reflecting different rules and regulations in different ports.
- Proposal for definition of responsibilities for different involved parties including landside and waterside authorities regarding OPS, both in case of normal operation and in case of malfunction or emergency.
- Proposal for check-list templates to assist in the tests/verifications outlined in IEC/IEEE 80005-1, IEC/IEEE 80005-3 and EN standards, respectively for HVSC, LVSC and IWT shore-side electricity supply.
- Proposal for a harmonized approach to the approval of OPS projects.

1.3 Exclusions and limitations

The EMSA Guidance on OPS excludes:

- OPS technical requirements or design aspects otherwise covered in the relevant IEC/IEEE 80005 series.
- Operational provisions for the ship side as defined and covered in the IMO OPS Guidelines [5].
- Cost, financial, or economic aspects of OPS, SBC or SPB.
- Electrical power supply during docking periods, for example dry docking and other out of service maintenance and repair.
- Identification of the entities responsible for investing or providing OPS, SBC or SPB as different models may be applicable in each specific case.

The EMSA Guidance on SSE is intended to be fully aligned with the IMO OPS Guidelines and IEC/IEEE 80005 series standards. In pursuing that objective, no repetition of requirements for the ship side are made which may be subject to possible changes. In addition, and complying with legal requirements for copyright, no transcriptions of standards are made. Instead, the EMSA Guidance is limited to a referencing tool.

When proposing checklists or flowcharts, as those included in Annex-A, respectively, there is a reference to the different provisions in the IMO OPS Guidelines [5]. These are however proposed for a harmonized adoption of instruments to facilitate communication and implementation of the existing operational provisions on the ship-shore interface

1.4 SSE from planning through operation

The diagram below indicates the sequence of the SSE installation phases as covered in the present Guidance document.

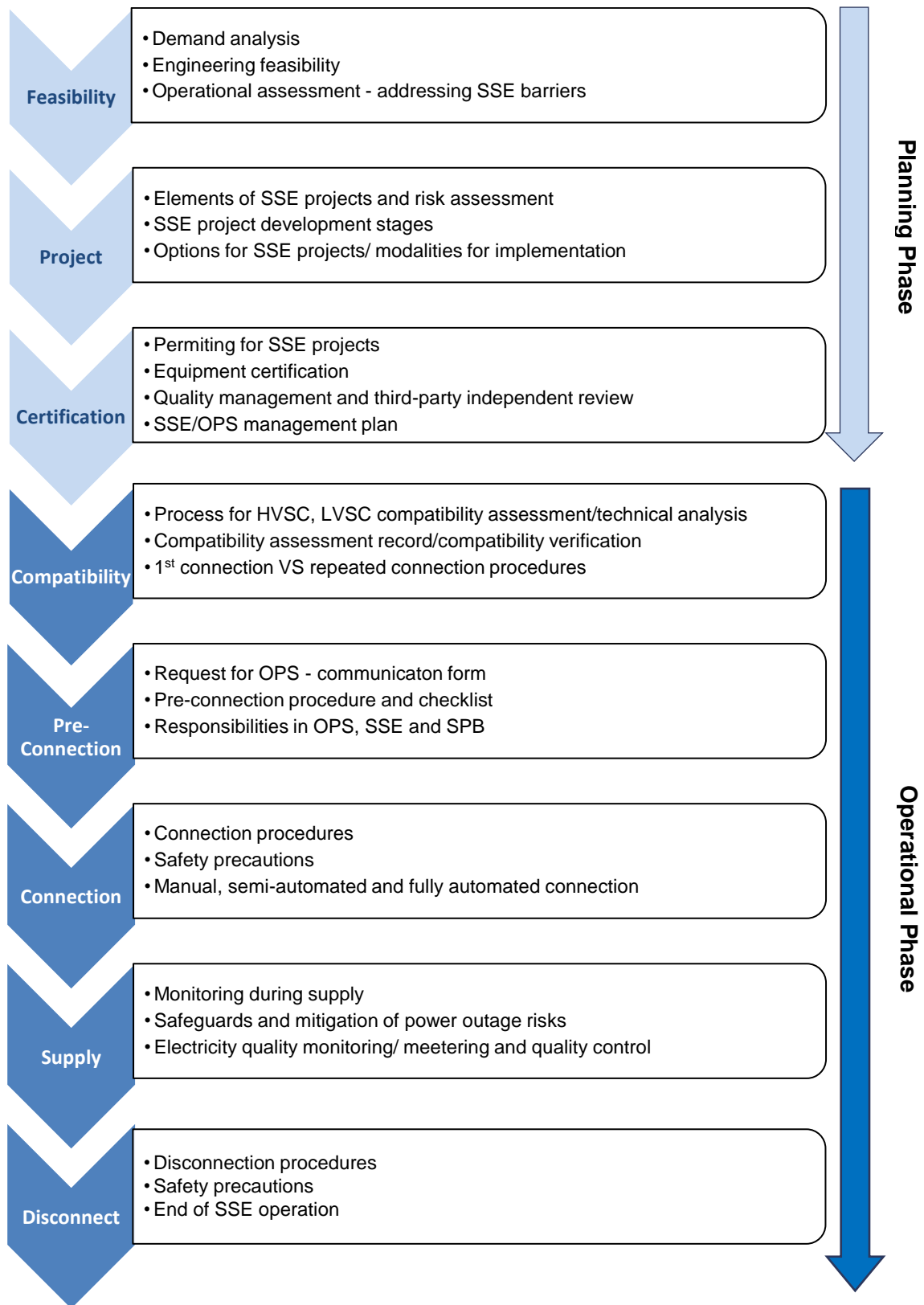

Figure 1.2 - SSE installation phases – from planning to operation.

1.5 Terms & definitions

Table 1.2 – Terms and definitions.

Term	Definition
Cable management system	Equipment designed to control, monitor, and handle the flexible power and control cables and their connection devices.
Certification	<p>Certification refers to the confirmation of certain characteristics of given equipment, in its whole or any of its parts, of procedure, operation or personnel, often requiring a confirmation of conformity against an existing standard or regulation.</p> <p>In the context of OPS, certification refers primarily to the OPS equipment, systems, and personnel. Can be applicable to systems with different complexities, provided rules, standards and regulations exist for conformity evaluation.</p>
Connector	Coupling device employed to connect conductors of one circuit element with those of another circuit element.
Consequence	Outcome of an event.
Electrical Installation	Plant with electrical equipment for generating, transmitting, converting, distributing, and using electrical energy EN 50110-1.
Equipotential bonding	Provision of electric connections between conductive parts, intended to achieve equipotentiality. [Source: IEC 60050-195:1998, 195-01-10]
Fail-Safe	Able to enter or remain in a safe state in the event of a failure. [Source: IEC 60050-821:2017, 821-01-10]
Feasibility Study	A Feasibility Study is an analysis of how successfully a project can be completed, accounting for factors that affect it such as engineering/technological, safety, legal or social factors. The goal of a feasibility study is to place emphasis on potential problems that could occur if this project is pursued and determine if, after all significant factors are considered, the project should be pursued. Feasibility studies also allow a business to address where and how it will operate, potential obstacles, competition and the funding needed to get the business up and running.
First Connection	First call at a shore-supply point.
Hazard	Potential source of harm. The hazard, or danger, is intrinsic to the product. See Regulation (EC) No 765/2008 on General Risk Assessment Methodology.
HAZID	Hazard identification (HAZID) study is the method of identifying hazards to prevent and reduce any adverse impact that could cause injury to personnel, damage or loss of property, environment, and production, or become a liability. HAZID is a component of risk assessment and management. It is used to determine the adverse effects of exposure to hazards and plan necessary actions to mitigate such risks.
HAZOP	<p>Hazard and Operability (HAZOP) is a structured and systematic examination of a complex planned or existing process or operation to identify and evaluate problems that may represent risks to personnel or equipment.</p> <p>HAZOP is a well-known and well documented study. HAZOP is used as part of a quantitative risk assessment or as a standalone analysis. HAZOP is a more detailed review technique than HAZID.</p>
High voltage (HV)	Nominal voltage in above 1,000 V AC and 1,500 V DC.
International Standard	An international standard provides rules, guidelines, or characteristics for activities or for their results, aimed at achieving the optimum degree of order in each context. It can take many forms. Apart from product standards, other examples include test methods, codes of practice, guideline standards and management systems standards.
Low voltage (LV)	Nominal voltage up to and including 1,000 V AC and 1,500 V DC.
Onshore Power Supply (OPS)	Onshore Power Supply (OPS) is the system to supply electricity to ships at berth, at low or high voltage, alternate or direct current, including ship side and shore side installations, when directly feeding the ship main distribution switchboard for powering hotel, service workloads or charging secondary batteries.
Operation	All activities necessary to permit the electrical installation to function. These activities include matters as switching, controlling, monitoring and maintenance, as well as both electrical and non-electrical work.
Permitting	<p>Permitting refers, in the context of SSE, to an official and documented authorization to build, implement or operate. There are several different types of permits (environmental permit, building permit, etc) depending on which instruments are used to assess a given project.</p> <p>The 'permit holder' is subject to a list of obligations designed to allow demonstration of compliance with regulations and standards relevant for the permitting processes.</p>

PRC3	Protection Relays, Communication and Control – PRC3 is referred in the Guidance as the collection of protection relays associated to communication, data exchange and control data exchange, compliant with the technical provisions of IEC/IEEE 80005-2:2016
Pilot Contact	Contact of the plug and socket-outlet, which signals correct plug connection and is a safety related component.
Receiving Point	Connection point of the flexible cable on the ship.
Restriction	Restriction represents a limitation, either on the utilization of specified equipment or system, or in the implementation of a given procedure, as far as shore-side electricity is concerned.
Risk	Possibility of occurrence of a hazard.
Risk level	Combination of the probability of occurrence of a hazard generating harm in each scenario and the severity of that harm. Degree of risk, which may be 'serious', 'high', 'medium' or 'low'. When different levels of risks in different scenarios have been identified "the risk" of the product is given by the highest risk.
Safety Circuit	Normally closed interlocking circuit with pilot contacts and safety devices that shuts down the HVSC system in response to specific initiating events.
Ship-side installations	Onboard systems that are designed to accept shore power, typically involving incoming power receptacles and plugs, shore connection switchgear, and protections, transformer (if applicable), incoming switchgear and protections at the main switchboard, power cables (herein referred to as cables), automation, cable monitoring system and associated instrumentation [5].
Shore-side Battery Charging (SBC)	Shore-side Battery Charging (SBC) is the system to supply electricity to charge secondary batteries of ships at berth, at low or high voltage, direct current, including ship and shore side installations.
Shore installations	Equipment that is installed at quay or port for OPS, typically involving switchgear and protections, transformers, frequency converters (if applicable), output power receptacles and plugs, cable management and associated instrumentation [5].
Shore-side circuit breaker	Dedicated switching and protection device on the shore side which connects and disconnects shore-side power to the ship.
SSE Management Plan	An SSE management plan, in the context of the present Guidance, represents a system-base quality management system, gathering all the information, certificates, procedures, and checklist(s) necessary for an effective and safe SSE operation. The SSE Management Plan is the proposed placeholder for filing and life-cycle management of compatibility assessment certificates.
Technical Standard	For the purposes of this document, technical standards are standards that prescribe requirements for one or more of the following: operations, equipment design/fabrications, or testing methodology.
Voltage ranges	The International Electrotechnical Commission (IEC) defines in IEC60038 supply system low voltage as voltage in the range 50 to 1000 V AC or 120 to 1500 V DC. In electrical power systems low voltage most commonly refers to the mains voltages as used by domestic and light industrial and commercial consumers. "Low voltage" in this context still presents a risk of electric shock, but only a minor risk of electric arcs through the air.

IEC Voltage r	AC RMS voltage (V)	DC Voltage	Defining risk
High Voltage	> 1000	> 1500	Electrical arcing
Low Voltage	50 to 1000	120 to 1500	Electrical shock
Extra-low Voltage	< 50	< 120	Low Risk

IEC/IEEE 80005 defines, in line with IEC 60038:

- **HV** – High-Voltage - nominal voltage in range above 1 000 V AC and up to and including 15 kV AC
- **LV** – Low Voltage - nominal voltage up to and including 1 000 V AC

For the sake of alignment of the present Guidance with the IEC/IEEE series, the same thresholds for voltage classification are followed.

It is to be noted that other voltage classifications are possible. even it is often found a reference to "Medium Voltage" in different standards. Except where specifically mentioned otherwise, "Medium Voltage" corresponds to the range between 1 kV and 52 kV, corresponding to the selected range applicable for IEC 62271 series (High-voltage switchgear and control gear).

2. SSE General block architecture

The present section includes general SSE systems architecture, including identification of the main infrastructure elements, examples of technological solutions and the different practical applications for OPS, SBC and SPB.

Figure 2.1, includes the main component block typically observed in a shore-side energy infrastructure.

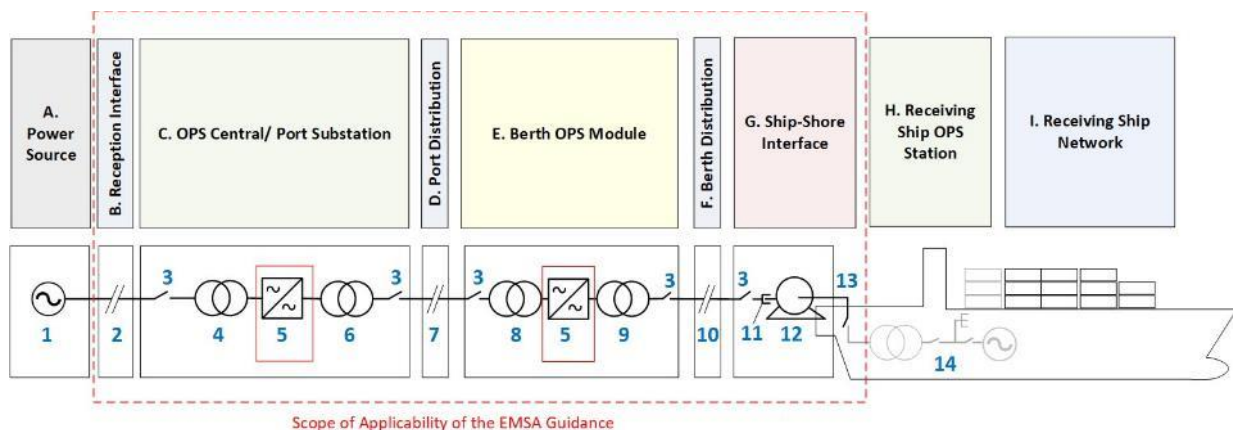

Figure 2.1 - Diagram with main component blocks for typical SSE system architecture/ layout.

Source: EMSA

The main blocks depicted from the figure are (letters and number refer to the letters in the coloured blocks and blue reference numbers, respectively):

- A. MV Supply – Main Voltage Supply (1), power source, from where HV is sourced (can be either the national/local HV distribution grid, with input voltages of 6,6-36 kV AC, or other voltages AC/DC resulting from local power production, including port shore/offshore power plants).
- B. Reception interface, where the electricity is transferred into the port area. It may be an element of cable routing, overhead or underground (2), HV, providing the OPS central/port substation with the electricity at energy contract characteristics. This is the point at which contractual electricity supply is verified.
- C. OPS central/port substation, including:
 - Circuit breakers (3)
 - Step-down, step-up or protection transformers (4), (6), to bring HV to MV/LV for port/berth distribution voltage. Transformers are fundamental technological enablers for OPS. They allow for voltage adjustment and provide for isolation.
 - Frequency Conversion (FC) (5) in centralized OPS systems (designed for adjusted frequency supply, depending on ship-specific requirement). Typically, in EU ports, the supply of AC 60 Hz to ships⁴ requires FC.
- D. Port distribution, taking the HV/LV lines from the OPS central/main substation to the different berth OPS modules, typically underground. The distribution may be done at HV/LV depending on the best assessment of the distances for cable routing and the efficiencies associated to the different distribution concepts.
- E. Berth OPS modules, which may be rather simple, containing only step-down or isolation transformers, (8), (9). In de-centralized systems the frequency conversion is done for dedicated

⁴ Frequency in EU is 50 Hz – For details on AC frequency compatibility see Section 3.9– Typically international ships may require 60 Hz supply.

berth OPS modules. This is typically the situation when high-power consumers/ships are to be served by OPS supply infrastructure.

- F. Berth distribution (10) where the electrical energy is distributed at berth level directly to OPS supply points.
- G. Ship-shore interface, including the infrastructure elements relevant for cable handling, either or HV/LV shore connection. Manual, semi-automated or fully automated systems may be deployed. Cable for connection (11) may be provided by the shore side or the ship side, including a cable reel on one of the sides for flexibility in the extension for connection. One of the most important elements for interconnectivity is located at the ship-shore interface: the connector, typically of plug-and-socket type (12).
- H. Receiving ship OPS station (ship-side) where the main ship-side circuit breaker (13) and switchgear are located.
- I. Receiving ship network (ship-side) including main switchboard, onboard generators, and onboard consumers (14).

Not represented, but of relevance, are the monitoring and control aspects. These are subject of IEC/IEEE 80005-2 Utility connections in port – Part 2: High and low voltage shore connection systems – Data communication for monitoring and control [6].

The blocks presented above are typically corresponding to an Onshore Power Supply (OPS) solution. Different detailed configurations and details may be in place for a variety of different port-specific solutions, and it is important that PAA have into consideration that OPS infrastructure should be designed to meet port-specific requirements and expected berth loads at typical operational usage profiles.

Below, two different examples are shown:

1. Without frequency conversion and with onboard HV/LV step-down transformer (Figure 2.2)
2. With frequency conversion and with onshore HV/LV step-down transformer (Figure 2.3)

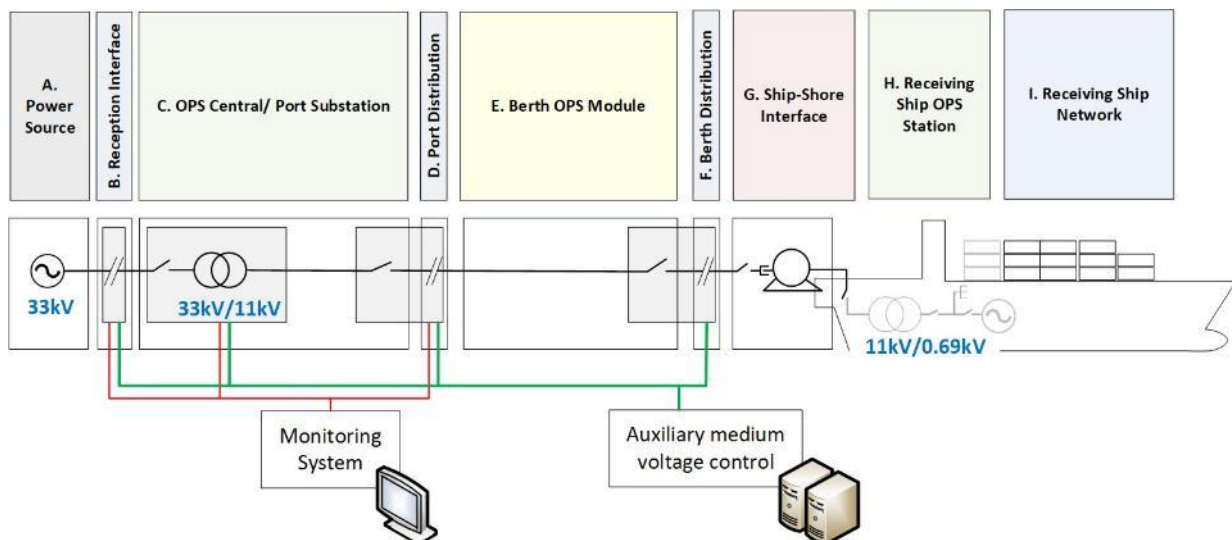

Figure 2.2 - SSE/OPS example - without frequency conversion and with onboard HV/LV step-down transformer.

Source: EMSA

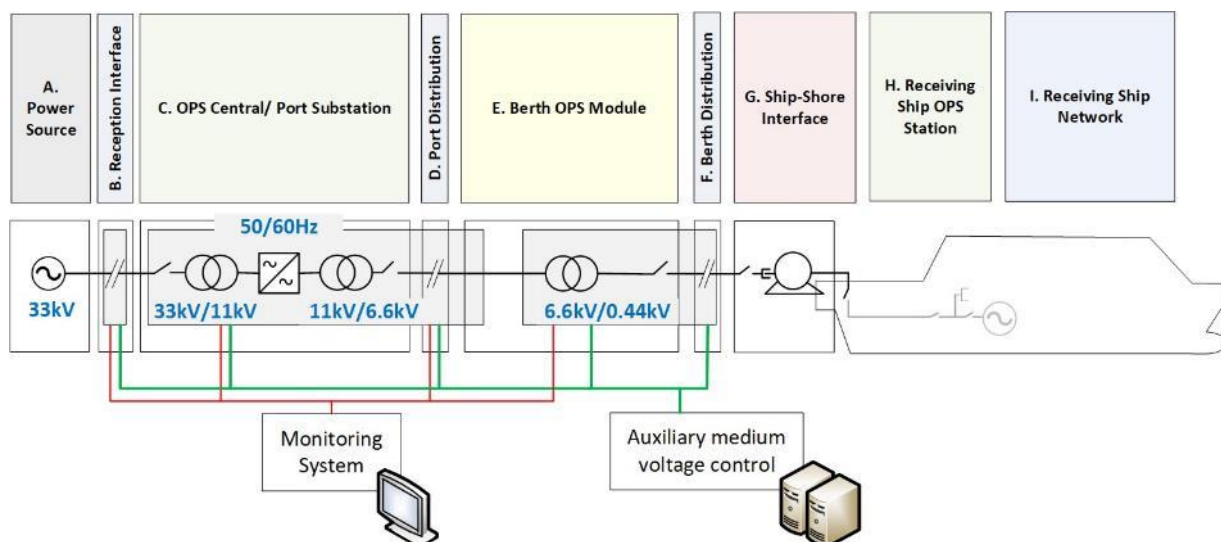

Figure 2.3 - SSE/OPS example - with frequency conversion and with onshore HV/LV step-down transformer.

Source: EMSA

Different ports, with different economic and operating profiles will inevitably require different specific solutions with a view to provide a meaningful service which can ensure optimum utilization rates and represent a solution which is able to respond to the expected load demand and energy utilization from ships connecting to SSE.

Despite only having presented examples for OPS, SBC and SPB are also relevant in the context of the present Guidance. Part 2 Section 4 of the Guidance addresses all these SSE arrangements.

Part 2 Section 4.3.1 of the Guidance outlines the relevant project-specific elements/design drivers to take into account when designing a high-voltage shore connection (HVSC), it is important to consider:

- a. Feasibility of OPS project, on a life-cycle basis, taking into account financial and socio-economic cost benefit analysis and engineering feasibility aspects.
- b. Project structure, ownership of installations, maintenance, operation, economic exploration. PAA need to define the framework for the OPS project development (Private? Public? Partnership?). Interdependency in evaluation, certification, life-cycle analysis and risk assessment is fundamental, regardless of the exact arrangement in the project terms.
- c. Shore-side frequency is an important project aspect to address. AC electricity frequency available in the main grid distribution will be different in different parts of the world (see section 3.9). Compatibility of ship-side and onshore supply is to be ensured by means of static or rotating converters. (e.g. 50 Hz in Europe, 60Hz in the US) and onboard frequency (50 Hz or 60Hz), given that 70% of ships are designed for 60Hz and 30% of ports supply 50Hz power [7]. Shore connection systems must thus be designed for both frequencies.
- d. The shore-side high-voltage electricity supply (voltage and distance to nearest supply point). It is important to design contract arrangements with the electricity supplier well in advance, preferably before concept design development. The electricity supplier will be responsible for providing the HV input into a required interface.
- e. Required power onboard, for the ship or group of ships expected to be served simultaneously by the OPS system. For electricity supply for ships with higher power demand (Since Power equals Voltage (V) x Current (I), the higher the voltage, the lower the currents and associated heat losses. Also a lower number of cables to be handled in electricity supply to ships. Ships would step-
- f. Available space on shore, civil engineering considerations, and docking patterns at port
- g. Space and weight restrictions for onboard transformer when required
- h. Installation practicalities
- i. Environmental conditions

- j. Onboard cable installation practicalities and distances
- k. Cost of shore-supplied electricity versus that of onboard-generated electricity (including fuel, maintenance, etc.) One of the main specificity of the shore connection system, is the big difference between ships regarding the necessary power when berthed. Hence, shore connection equipment must be suitable for ships of all types and sizes (see Part 2 Section 7.4 on ship-specific related aspects).

3. SSE – General infrastructure and equipment

The present section covers the main infrastructure and equipment elements typically involved in SSE projects. The general SSE diagram is used as a map to locate the different equipment in the SSE setups.

It should be acknowledged, that ports will see the implementation of different projects, depending on power requirements, level of automation required, power source(s) available and specific ships to be connected.

The elements presented here are intended as familiarization guidance. For a complete understanding of the different design requirements for the systems and equipment presented, each section includes a set of references for further reading.

3.1 Power source

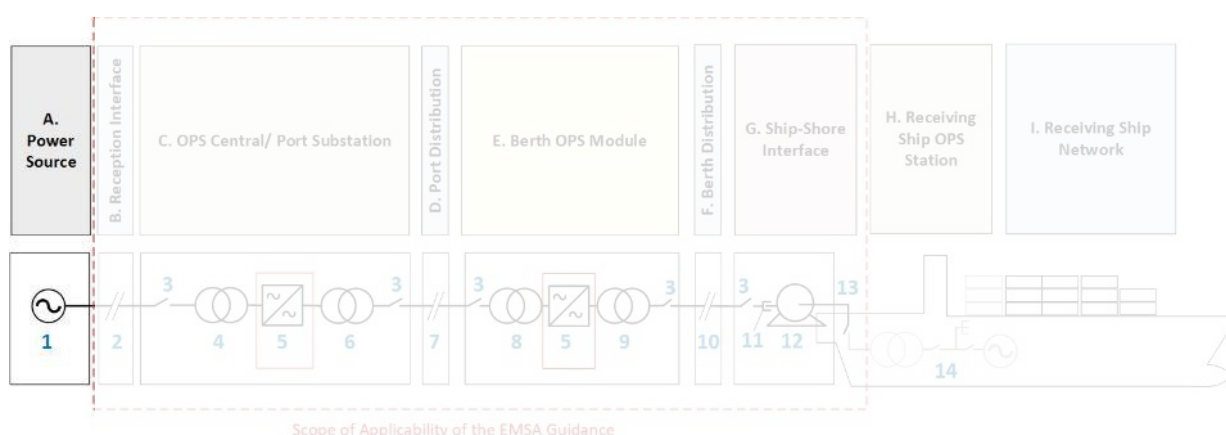

Figure 3.1 - Power source.

Source: EMSA

The source of power is the one that supplies the SSE with electrical energy. It is designed to provide electricity with determined values for parameters such as current, the amplitude, the phase, or the frequency, and even if it is a single-phase or a three-phase source.

To allow standardisation of the HV shore supply and link nominal voltage in different ports, HV shore connections shall be provided with a nominal voltage of 6,6 kV AC and/or 11 kV AC galvanically separated from the shore distribution system, in accordance with requirements of IEC/IEEE 80005-1 [8].

The operating frequencies (Hz) of the ship and shore electrical systems shall match; otherwise, a frequency converter shall be utilized ashore.

For ships operating in determined terminals within the port area, where ships call frequently other IEC voltage nominal values may be considered (see IEC 60092-503). This is stated in IEC/IEEE 80005-1 [8] and IEC/IEEE DIS 80005-2 [9], respectively for HV and LV grid sources. It should be given careful consideration by PAA what the impact of such arrangement in terms of infrastructure flexibility would be.

Even though the source of power is not included in the scope of the present Guidance document, it is considered as a critical element for the feasibility, sustainability, and security of the SSE energy supply chain. Regardless of the actual layout, the source of power can be:

- 1) **National electricity grid** distribution, feeding substation within/close to the port area. It is important to consider the need for HV infrastructure to be routed from a HV substation down to the port area. HV incoming lines may be aerial or underground, depending on the feasibility, engineering, and safety analysis. For ports integrated in urban areas, HV routed by underground cables, in ducts or tunnels, may represent the most feasible option.
- 2) **Port generators** (floating or shore units, Figure 3.2 and Figure 3.3, respectively) may provide a flexible option to address either 1) excessive costs of grid electricity or 2) requirement for flexibility in the electricity supply.

- 3) **Renewable Energy** plants (wind, shore or offshore, photovoltaic (PV) panels), depending on the port location or available area for development of renewable energy solutions. Renewable energy options will always be provided in conjunction with electrical energy storage systems (battery modules).
- 4) **Electrical Energy Storage**, to be used in conjunction with distributed networks where irregular energy production is to be accounted for, typically with the introduction of renewable energy solutions.
- 5) **Emergency back-up power** units, representing, in practice, an option to complement energy security.



Figure 3.2 – Floating port generator.

Hamburg based LNG Power Barge (*Hummel* LNG Hybrid Barge), with a total installed power of 7.5MW.

Source: Becker Marine Systems



Figure 3.3 - Modular power units - containerized electricity production units.

These port generators can be placed where most needed, providing flexibility and improved sustainability if using cleaner fuels as LNG.

Source: Becker Marine Systems

PAA should consider the possibility to combine the different power sources above described, to suit the requirements of specific SSE projects. In addition, SSE projects should be integrated into the wider range of energy solutions available in the port area, potentially including other different consumer units, fixed and mobile infrastructure.

In particular for the integration of renewable energy sources with the main grid for SSE supply, which are characterized by intermittent and low specific power production, thus inevitably having to be deployed together with some type of energy storage systems (typically battery systems), different local and port specific aspects need to be considered such as: 1) port size and installed power of consumers connected for electrical supply; 2) local availability of renewable energy sources (regional, local or port developed); 3) feasibility of high voltage connection to grid; 4) operating profile and power demand of the ships at berth.

The connection of the port to utility network should follow the project agreed between the port and the network supplier, reflecting the specific user requirements, and include from the start the following central aspects:

- Maximum supply size estimated (in Amps)
- Total installed power to be connected (MVA)
- Location for the reception substation
- Type of metering and metering contract to be agreed

For microgeneration, by renewables or other port-based energy production sources, it should be agreed at a very early stage, during design development, to which extent will the port opt to connect these power generation units to the grid or if, instead, the electricity generated will be used strictly for the ports' consumption. For power connection of microgeneration to the utility grid it is possible to have the electricity produced, in excess of port's energy storage capacity.

Power Source - References and further reading:

- A. Overview of electricity production and use in Europe (EEA) [10]
- B. IEEE 1547 and 2030 Standards for Distributed Energy Resources Interconnection and Interoperability with the Electricity Grid
- C. Wind Energy/ Wind turbines: IEC 61400-series, IEC 60050-415 -
- D. Solar/PV systems: IEC 62548, 60364-7-712, 61683, 62093, 62116, 62446, 61724, 61850-7, 60870, 61701
- E. Fuel Cell plants: IEC 62282 series
- F. Energy Management ISO 50001 / ISO 9001 / ISO 14001 - Energy Quality and Environmental Management Systems Package
- G. IEEE 1250-2018 - Guide for Identifying and Improving Voltage Quality in Power Systems
- H. EN 45510-2-4:2001 - Guide for procurement of power station equipment - Part 2-4: Electrical equipment; High power static convertors
- I. EN 45510-2-3:2001 - Guide for procurement of power station equipment - Part 2-3: Electrical equipment; Stationary batteries and chargers
- J. DIN EN 45510-2-2:1999 - Guide for procurement of power station equipment - Part 2-2: Electrical equipment - Uninterruptible power supplies
- K. IEEE 1366-2012 - Guide for Electric Power Distribution Reliability Indices
- L. IEEE 1515-2000 (R2008) - Recommended Practice for Electronic Power Subsystems: Parameter Definitions, Test Conditions, and Test Methods

3.1.1 Characteristics, metering, and quality of electricity supply

From a standardisation perspective, electricity quality is of central relevance. AC electrical supply is mainly characterized by voltage and frequency, as these two parameters relate directly to the compatibility of shore-ship connection. There are however other important parameters to monitor and consider when quality of electricity is to be addressed.

Electrical faults, blackouts, transient overvoltage/overcurrent episodes or electrical equipment breakdown may all lead to claims/disputes. It is important that PAA give adequate consideration for the measurement, metering and recording of electrical power quality.

Characteristics of electricity are presented with a reference to IEC/IEEE 80005 series. Other standards exist with a reference to quality criteria (e.g., EN50160) which are not considered the main reference for SSE electricity quality.

Metering is highlighted as a function with a two-fold objective (to measure the electricity supplied for contractual reasons, but also to measure the quality parameters).

Electricity quality control is a central functional requirement for SSE, not only from a compatibility perspective but, more importantly for energy security during ship-shore connection.

3.1.1.1 Characteristics

Electricity may be supplied to ships with different characteristics, depending on ship-side grid demand. Whilst high-voltage supply currently follows a standardised 6.6/11 kV AC rating, as per IEC/IEEE 80005-1 (section 5.1), Table 3.1 presents the different rated characteristics, as standardised in the relevant references, for SSE electricity supply (measured at the point of supply).

Table 3.1- Electricity characteristics for SSE (values presented at the supply point) – Only AC supply characteristics are presented.

Parameter	Reference(s)	High Voltage Shore Connection (HVSC)	Low Voltage Shore Connection (LVSC)
Voltage	IEC/IEEE 80005-1 IEC/IEEE DIS 80005-3 IACS Unified Requirements Electrical (Rev.1 Sept 2005)	6.6 kV 11 kV	400 V 440 V 690 V 230 V also possible for less demanding consumption <50 kW
Voltage Tolerances		No-Load Conditions: 6% of nominal Voltage increase Load Conditions: 3.5% max voltage drop	No-Load Conditions: 6% of nominal Voltage increase Load conditions: 5% (3.5%)⁵ max voltage drop
Frequency	See Figure 2.3	50/60 Hz DC for Fast DC Charging systems	
Frequency Tolerances	IEC/IEEE 80005-1 IEC/IEEE DIS 80005-3 IACS Unified Requirements Electrical (Rev.1 Sept 2005)	Continuous tolerance: $\pm 5\%$	
Transient Response		dV (voltage transient peak variation): $-15\% < dV < 20\%$ (1.5sec) df (frequency transient variation): $\pm 10\%$ (5sec) Transient Response should be well known and documented for: <ol style="list-style-type: none"> <u>Shore-side</u>, for the voltage and frequency response, when subject to an appropriate range of different load step changes, <u>Ship-side</u> for the maximum step change in load expected (this can be an Air Conditioning compressor, electrical pump, crane or electrohydraulic group). The part of the system subjected to the largest voltage dip or peak in the event of the maximum step load being connected or disconnected shall be identified; Combining 1) and 2) it should be verified that the voltage transients limits of $+20\%$ and -15% and the frequency transients limits of $\pm 10\%$ will not be exceeded.	
Harmonic Distortion		For no-load conditions, voltage harmonic distortion limits: $< 3\%$ (single harmonics) $< 5\%$ (for total harmonic distortion)	
Voltage variations for DC supply	IACS Unified Requirements Electrical (Rev.1 Sept 2005)	Voltage tolerance (continuous)	$\pm 10\%$
		Voltage cyclic variation deviation	5%
		Voltage ripple (RMS over steady DC voltage):	10%
Voltage variations for battery systems		Components connected to the battery during charging:	+30%, -25%
		Components not connected to the battery during charging:	+20%, -25%
		Note: Different voltage variations as determined by the charging/discharging characteristics, including ripple voltage from the charging device, may be considered.	

⁵ IEC/IEEE DIS 80005-3 – mentions 3.5%, aligning the maximum voltage drop under loading conditions with the HVSC standard (IEC/IEEE 80005-1). Irrespective of the alignment between the standards, it is important to keep the voltage drop under the shore-power loading condition

Voltages indicated for HVSC as per IEC/IEEE 80005-1. For HVSC it can be assumed that a good degree of standardisation has been achieved, with 6.6 kV and 11 kV as the generally accepted standard HV nominal ratings. Room for other HV ratings is made in the standard, in section 5.1, for cases where ships undertake a repeated itinerary at the same ports and their dedicated berths, (...) (see IEC 60092-503). This is understood to be an important point to allow flexibility for tailor-made/customized arrangements. However, from a best-practice perspective PAA should consider this possibility only in the cases where the SSE solution implemented does not impose a disadvantage for other operators visiting the same berth location.

The voltages indicated for LVSC are as indicated in DIS IEC/IEEE 80005-3, with 400 V, 440 V and 690 V mentioned as standard values. For LV however the widespread standardisation is less attainable and a cautionary reference to IEC 60092-201 for standard voltage values is made in the draft standard.

The definition of the possible range of supply voltages will have a direct impact on the SSE infrastructure and equipment to be installed. It is important that PAA include due consideration to the required voltages for different ship segments and, in some cases, even to specific ships. The same is valid for AC frequencies but it is important to acknowledge that even for the same frequency 50/60 Hz different voltages may be required for specific ship connections. This is an important aspect from an engineering feasibility perspective.

The characteristics presented follow the requisites of IEC/IEEE 80005-1 for tolerances and transient response limits. For LVSC the reference is expected to be similar. This is indeed reflected in the DIS IEC/IEEE 80005-3 which, despite not being finalized yet, already contains the same envelopes for both tolerances and transient excursions.

For both HVSC/LVSC it is important to consider an adequate set of protections against fast transient overvoltage surges (as those typically induced by lightning strikes or switching operation).

The exact response profile of the shore connection will be highly dependent on the ship-side load step variation profile. It is important for PAA to consider the need for a well-documented load consumption profile for each ship to be connected. The shore supply installation should be, on one hand, sufficiently robust to accommodate for transient load variations on the ship side but, on the other, ensure the adequate protection to the SSE infrastructure/equipment.

The voltage and frequency tolerances indicated in Table 3.1 are those defined in IEC/IEEE 80005-1. The standard opens however room for different voltage and frequency tolerances, if defined by local authorities responsible for SSE at different ports. Despite the existence of different tolerance envelopes not being the ideal situation, it is important to ensure that these shall be considered as part of the compatibility assessment to verify the effect on the connected ship load is acceptable.

The characteristics listed in Table 3.1 should be considered by all PAA as the standard references for SSE development. Feasibility studies and compatibility assessments should have well documented elements justifying any differences to the voltage ratings, tolerances, and transient response thresholds. Due reference to IEC 60092-201:2014 should be made whenever different electrical supply parameters are defined.

Where the possible loading conditions of a ship when connected to a HV shore supply would result in a quality of the supply different from that specified in IEC 60092-101:1994/AMD1:1995, 2.8, due regard shall be given to the effect this may have on the performance of equipment. Safety sensitive functions of different equipment onboard should be regarded with particular attention.

Whilst AC power supply is standardised for HV, and to a good degree also to LV, the supply of DC electrical power is today an application still with a limited expression. Supply of DC electrical power is a particular feature of battery charging installations where the charging transformer is placed ashore. This is the configuration typically named “fast DC charging” or simply “fast charging” where the size of the charging unit is not limited by space constraints onboard and, instead, placed ashore and given adequate technical characteristics which allow the battery charging operation to be done at a higher power. For the case of battery charging, in addition to voltage, it is also important to consider the current rating which will be correspondent to the desired charging power at a given voltage rating.

In the absence of a specific standard for DC marine battery charging, it is considered as best practice to use the IEC/IEEE 80005 series for any relevant electrical power quality reference, as applicable. As far as electrical current is considered, given the sensitivity of modern li-ion battery cells to its variations, this should be a particular electrical power parameter to monitor and record.

3.1.1.2 Power Quality

The quality of electrical power may be described as a combination of the following four characteristics:

- A. **Continuity** of service (whether the electrical power is subject to voltage drops or overages below or above a threshold level thereby causing blackouts or brownouts⁶)
- B. Variation in **voltage magnitude** (see Figure 3.4)
- C. **Transient** voltages, currents, and frequencies
- D. **Harmonic** content/distortion in the waveforms for AC power

Quality of energy supply to be assessed in accordance with Section 5 of IEC/IEEE 80005-1 [8] and IEC/IEEE DIS 80005-3 [9], considering the voltage and frequency tolerances, transients, and harmonic distortion.

The power quality is demonstrated through adequate monitoring of selected parameters. Table 3.1 provides the reference characteristics for electrical power monitoring as per IEC/IEEE80005 series. The voltage thresholds are translated into the graphic in Figure 3.4 with the indication of the different voltage event threshold magnitudes.

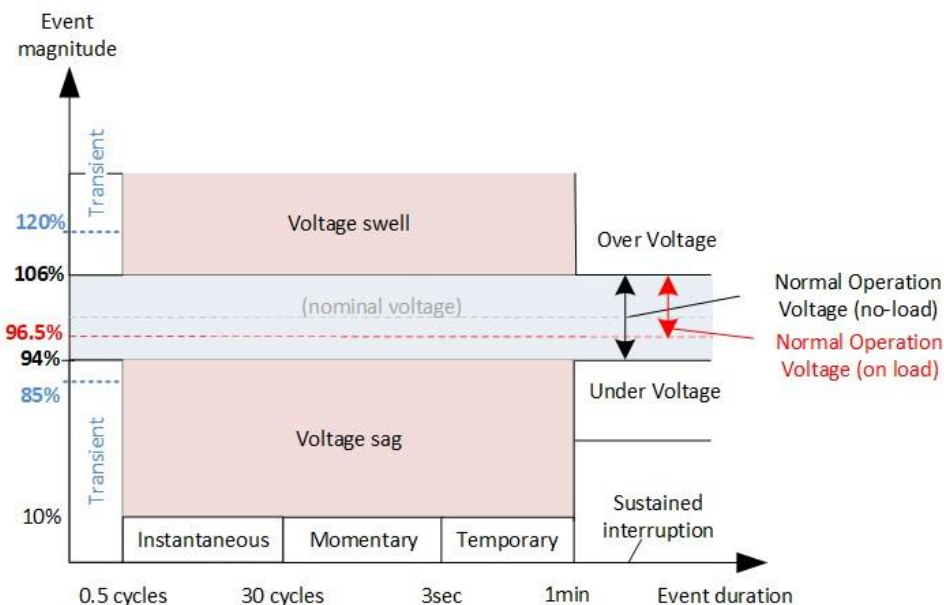

Figure 3.4 – Voltage reference thresholds for SSE electrical power quality monitoring. In blue the transient thresholds are presented for peaks not longer than ½ cycle.

Source: EMSA

In addition to voltage, also frequency is identified in Table 3.1 as a key parameter to observe with respect to power quality. An example, in Figure 3.5, shows a frequency variation diagram bounded by the relevant reference threshold.

⁶ A **brownout** is caused by high electricity demand that is near or above a utility's production capacity. When this occurs, the utility may reduce the flow of electricity to certain areas to prevent a blackout. A **blackout** is a large-scale service interruption that can happen as a result of severe weather or equipment failure at power plants.

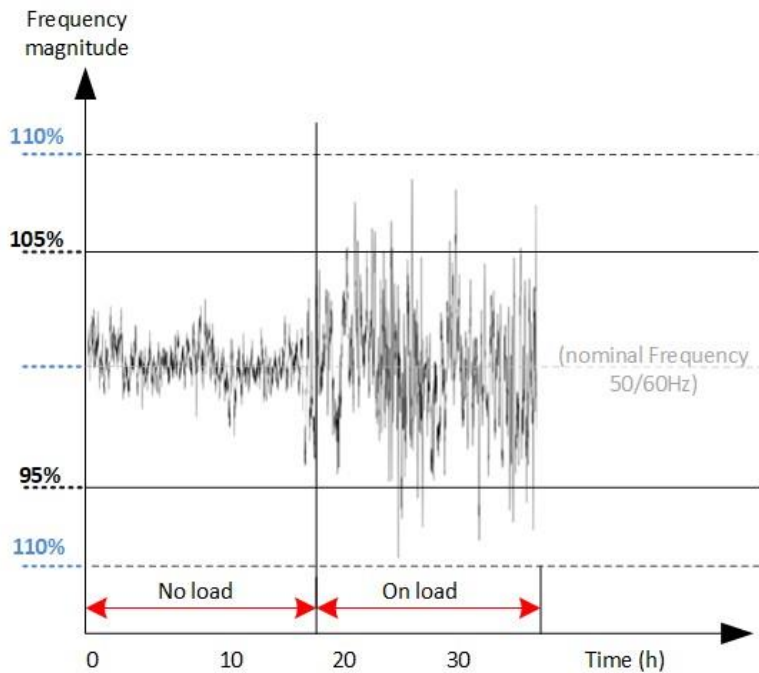

Figure 3.5 – Frequency reference thresholds for SSE electrical power quality monitoring. In blue the transient thresholds are presented for frequency variations under load.

Source: EMSA

It is reasonable to assess power/electricity quality as a compatibility problem: is the ship-side equipment connected to SSE compatible with the events on the shore supply side, and is the power delivered by SSE, including the events, compatible with the equipment that it is connected? Compatibility problems always have at least two solutions: in this case, either the cleaning up of the power, or the use of less sensitive equipment. Since SSE context represents, in practice, an interface energy supply, the aspects of compatibility are of high importance.

The parameters for electrical supply quality are measured at the electricity supply point.

Where digitalization solutions are adopted for energy quality analytics these should be approved by a competent authority.

The events leading to poor power quality are diverse and may affect electrical power quality in different ways. PAA should consider the risk of poor power quality as a risk directly related to safety, that should be mitigated through the adoption of adequate engineering solutions including, but not limited to, power quality monitoring, filters, automatic voltage regulation and transformers. The following table includes a non-exhaustive list of possible power quality deviations.







Table 3.2 Power quality deviations.

Electrical parameter	Causes
<u>Voltage</u> (Reference made to Figure 3.4)	<ul style="list-style-type: none"> • Variations in the peak or RMS voltage are both important to different types of equipment. • When the RMS voltage exceeds the nominal voltage by 10 to 80% for 0.5 cycle to 1 minute, the event is called a "swell". • A "sag" (also termed equivalently as "dip") is the opposite situation: the RMS voltage is below the nominal voltage by 10 to 90% for 0.5 cycle to 1 minute. • Random or repetitive variations in the RMS voltage between 90 and 110% of nominal can produce a phenomenon known as "flicker". • Abrupt, very brief increases in voltage, called "spikes", "impulses", or "surges", generally caused by large inductive loads being turned off, or more severely by lightning. • "Undervoltage" occurs when the nominal voltage drops below 90% for more than 1 minute. The term "brownout" is an apt description for voltage drops somewhere between full power (bright lights) and a blackout (no power – no light). It comes from the noticeable to significant dimming of regular incandescent lights, during system faults or overloading etc., when insufficient power is available to achieve full brightness in (usually) domestic lighting. • "Overvoltage": when the nominal voltage rises above 110% for more than 1 minute.
<u>Frequency</u> (Reference made to Figure 3.5)	<ul style="list-style-type: none"> • Variations in the frequency. • Nonzero low-frequency impedance (when a load draws more power, the voltage drops). • Nonzero high-frequency impedance (when a load demands a large amount of current, then suddenly stops demanding it, there will be a dip or spike in the voltage due to the inductances in the power supply line). • Variations in the wave shape – usually described as harmonics at lower frequencies (usually less than 3 kHz) and described as common mode distortion or interharmonics at higher frequencies.
<u>Waveform</u>	<ul style="list-style-type: none"> • The oscillation of voltage and current ideally follows the form of a sine or cosine function, however it can alter due to imperfections in the generators or loads. • Typically, generators cause voltage distortions and loads cause current distortions. These distortions occur as oscillations more rapid than the nominal frequency and are referred to as harmonics. • The relative contribution of harmonics to the distortion of the ideal waveform is called total harmonic distortion (THD). • Low harmonic content in a waveform is ideal because harmonics can cause vibrations, buzzing, equipment distortions, and losses and overheating in transformers.

Each of the power quality problems indicated in the table above has a different cause. Some problems are a result of the shared infrastructure where, for example, a fault on the network may cause a dip that will potentially affect some consumers. The higher the level of the fault, the greater the number of connections/consumers affected. A problem on one consumer site may cause a transient that affects all other consumers on the same SSE infrastructure grid. Problems, such as harmonics, arise within the customer's own installation and may propagate onto the network and affect other customers. Harmonic problems can be dealt with by a combination of good design practice and well proven reduction equipment.

For improved visualization, Table 3.3 includes typical variations, associated nomenclature, causes, most common originating sources, effects over equipment and a short sample list of examples of power conditioning solutions.

Table 3.3 - Summary table with example power quality variations, their common causes, sources, effect, and examples of power conditioning solutions.

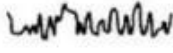
Example waveshape or RMS variation	Causes	Sources	Effects	Examples of power conditioning solutions
	Impulsive transient (transient disturbance)	Lightning Electrostatic discharge Load switching Capacitor switching	Affects computer components and power electronics	A. Surge arrestors B. Filters C. Isolation transformers
	Oscillatory transients (transient disturbance)	Line/cable switching Capacitor switching Load switching	Destroys computer components and power electronics	A. Surge arrestors B. Filters C. Isolation transformers
	Sags/swells (RMS disturbance)	Remote system faults	Motors stalling and overheating Computer failures ASDs shutting down	Ferroresonant (Constant Voltage) transformers Energy storage technologies Uninterruptible Power Supply (UPS) Backup generators
	Interruptions (RMS disturbance)	System protection Breakers Fuses Maintenance	Loss production Equipment shutdown	Energy Storage technologies Uninterruptible Power Supply (UPS) Backup generators
	Undervoltage/overvoltage (steady state variation)	Motor starting Load variations Load dropping	Shortens lives of motors and lighting filaments	Voltage regulators Ferroresonant (Constant Voltage) transformers
	Harmonic distortion (steady state variation)	Nonlinear loads System resonance	Overheating transformers and motors Fuses blow Relays trip Meters malfunction	Active or passive filters Transformers with cancellation of zero sequence components.
	Voltage flicker (steady state variation)	Intermittent loads Motor starting Arc furnaces	Lights flicker Irritation	Static VAR systems

In the rightmost column of Table 3.3 it is possible to find reference to different power conditioning systems. Power conditioning allows to modulate the power grid electricity before supply to consumer. In SSE infrastructure the role of power conditioning is essential to ensure parameters defined by IEC/IEEE 80005.

Various types of power conditioning equipment are available to protect SSE infrastructure and supplied/connected ships' equipment (sometimes sensitive electronic equipment) against power quality problems. Power conditioning equipment is highly recommended since unplanned disturbances on the electric utility's system will occur. An important decision-making process is required to define the adequate power conditioning equipment to mitigate specific SSE grid power quality problems.

The following table includes a list of the different power conditioning systems.

Table 3.4 - Power conditioning technologies.











Power conditioning system		Causes
Power enhancers	Surge suppressors	Surge and transient or spike suppressors are the simplest, least expensive way to condition power. They reduce the size of spikes to levels that are safe for your electronics. High energy surge suppressors are installed at the service entrance. Transient voltage surge suppressors (TVSS) also are installed at the terminals of the sensitive electronic load. They provide protection against lower energy, high voltage spikes. The service entrance suppressor is considered a minimum protection level, even if other power conditioners are employed.
	Voltage regulators	Voltage regulators maintain voltage output within a desired limit during wide fluctuations in the input. They might provide protection against spikes or noise and limited or no protection from rapid voltage changes. Voltage regulators respond best to slow changes in voltage. Automated Voltage Regulation (AVR) allow for automated adjustment of voltage variations, depending on the load profile.
	Isolation transformers	Isolation transformers protect sensitive electronic equipment by buffering electrical noise. They effectively reject common mode line-to-ground noise but are limited in their rejection to normal mode line-to-line or line-to-neutral noise. Isolation transformers do provide a "separately derived" power source and permit single point grounding.
Power synthesizers	Motor generators	Motor generators consist of an electric motor driving a generator. They convert incoming electrical energy into mechanical energy and back again into electrical energy. The mechanical shaft isolates the electrical load from incoming disturbances such as voltage impulses, surges, and sags. The motor generator rides through many short "momentary interruptions" but will not protect against sustained outages. Typical ride-through capability is 10-30 seconds.
	Standby power supply (SPS)	<p>For problems with power supply interruptions, use a standby power supply (SPS) or an off-line uninterruptible power supply (UPS). This device switches to a battery supply upon loss of utility power. Some designs include a transfer during certain power disturbances.</p> <p>The SPS is effective only when the equipment being protected can withstand the transfer time, usually a few milliseconds. When voltage is normal, the transfer switch returns to the normal utility feed. Standby power supplies are typically available for small loads such as personal computers.</p> <p style="text-align: center;">Standby Power Supply</p> <p style="text-align: center;">Source: EMSA</p>

<p>Uninterruptible Power Supply (UPS)</p>	<p>Uninterruptible power supply (UPS) devices provide power to critical loads at all times. The two classifications of UPS systems are "rotary" and "static." A rotary UPS uses some form of a motor generator to provide uninterruptible power, while a static UPS has no moving parts and typically uses power semiconductors.</p> <p>A static UPS system includes a rectifier/charger, a battery bank, a static inverter, and an automatic transfer switch. Direct current power feeds an inverter from either the rectifier or battery and is converted to conditioned AC power that serves the sensitive electronic equipment. A direct utility feed powers the on-line UPS. A DC bus backed by a battery provides conditioned power. An on-line UPS typically has a solid-state transfer switch for switching directly to utility power if an internal element fails within the UPS.</p> <p>Surge and transient or spike suppressors are the simplest, least expensive way to condition power. They reduce the size of spikes to levels that are safe for your electronics. High energy surge suppressors are installed at the service entrance. Transient voltage surge suppressors (TVSS) also are installed at the terminals of the sensitive electronic load. They provide protection against lower energy, high voltage spikes. The service entrance suppressor is considered a minimum protection level, even if other power conditioners are employed. There are different levels of TVSS equipment. Their performance specifications vary widely and may depend on price. TVSS performance degrades in time as it suppresses high voltage spikes, therefore, needs periodic replacement.</p> <div data-bbox="613 786 1370 1128" style="text-align: center;"> <p>The diagram illustrates the components and flow of an Uninterruptible Power Supply (UPS) system. On the left, a 'Power Source' (labeled G1 with a sine wave symbol) feeds into a 'Rectifier/Charger' block. This block is connected to an 'Inverter' block. A 'Bypass Line (if UPS fails)' branches off from the line between the Rectifier/Charger and the Inverter, going directly to an 'Automatic Transfer switch' before reaching the 'Protected Load'. Below the Inverter, an 'Energy Storage System (Battery)' (labeled BT1) is connected to the system. The Automatic Transfer switch is positioned between the Inverter and the Protected Load.</p> </div> <p>Figure 3.7– Uninterruptible power supply.</p> <p>Source: EMSA</p>
<p>Uninterruptible power supply with auxiliary generator</p>	<p>An uninterruptible power supply plus an auxiliary generator provides an even better supply system.</p> <p>This kind of system allows sensitive equipment to operate during lengthy utility outages. It may be a solution considered at places where local utility grid supply is often irregular (typically the case in some islands where power supply from diesel-generators is supplied with fluctuating quality).</p> <p>The generator starts automatically upon loss of utility power, very much like an onboard emergency generator, and the power source for the UPS will automatically transfer to the generator.</p>

Having information on the nature and characteristics of the different power quality problems (Table 3.2 and Table 3.3) and on the relevant applicable power conditioning technologies (Table 3.4) it is important to understand how these relate in practical terms. Which power conditioning technologies are best suited for the different power quality conditions?

The matrix in Figure 3.8 illustrates the effectiveness/adequacy of various power-conditioning equipment. Proper selection and application of the equipment requires an understanding of the type of disturbances likely to affect SSE infrastructure. Without proper conditioning, sags, momentary interruptions, or transients could adversely affect the performance of SSE connected ships' sensitive equipment.

Protections and power conditioning on the ship side may vary. Whilst some ships may have a significant gear for power quality monitoring and conditioning (as in the case of cruise ships), some others may be less equipped, more exposed to power quality fluctuations. PAA should ensure adequate SSE infrastructure considering the local utility, or decentralized, power quality supplied. Since power quality should be guaranteed by SSE facility organization, measured at the supply point [8], there should be no consideration given to power conditioning onboard. To this end the ship should be assumed to take no action on power conditioning, even if, for practical safety reasons, some power conditioning will inevitably also be taken onboard.

POWER QUALITY CONDITION		POWER CONDITIONING TECHNOLOGY								
		TRANSIENT VOLTAGE SURGE SUPPRESSOR	EMI/RF FILTER	ISOLATION TRANSFORMER	VOLTAGE REGULATOR (ELECTRONIC)	VOLTAGE REGULATOR (FERRORESONANT)	MOTOR GENERATOR	STANDBY POWER SYSTEM	UNINTERRUPTIBLE POWER SUPPLY	STANDBY ENGINE GENERATOR
	COMMON MODE	Red		Green	Red	Green	Green	Red	Red	
	NORMAL MODE	Red			Red	Green	Green	Red	Green	
	COMMON MODE		Red	Green	Red	Green	Green	Red	Red	
	NORMAL MODE		Red	Red	Red	Green	Green	Red	Green	
	NOTCHES			Red		Green	Green		Green	
	VOLTAGE DISTORTION					Red	Green		Red	
	SAG				Red	Red	Red	Red	Green	
	SWELL				Red	Green	Red	Red	Green	
	UNDERVOLTAGE				Green	Green	Green	Red	Red	
	OVERVOLTAGE				Green	Green	Green	Red	Red	
	MOMENTARY INTERRUPTION						Red	Green	Green	
	LONG-TERM INTERRUPTION									Green
	FREQUENCY VARIATION							Red	Green	Red

Green = It is reasonable to expect that the Power Conditioning Technology will correct the Power Quality Condition.
Red = The Power Conditioning Technology may not fully correct the Power Quality Condition.

Figure 3.8– Power Conditioning Technology for different Power Quality Conditions [11] .

3.1.1.3 Power factor

Power Factor (PF) and Power Factor Correction (PFC) are important concepts that should be considered by PAA when deciding on SSE infrastructure layout. The present section highlights:

- A. Power factor concept
- B. Importance of power factor and PFC in the context of SSE.
- C. How to determine PFC required
- D. Best practice in SSE PF implementation.
- E. Available equipment for power factor correction

Whereas power conditioning acts on power quality deviations from standard reference (voltage, frequency, harmonics), power factor correction acts over the efficiency of utilization of the power supplied to any given consumer.

Since the main consumers for SSE supply are ships it is possible to speak about PFC correction at both SSE or ship level, respectively PFC_{SSE} or PFC_{ship} , depending on where the PFC equipment is installed.

A. Power factor concept

The power factor of an electric load is the **ratio of real power to apparent power**.

- Real power is, as implied by its name, the actual power the load is consuming. It is represented by the letter P and measured in kilowatts (**kW**).
- Reactive power is a type of power drawn by inductive or capacitive loads - it flows back and forth between the load and the voltage supply, without being consumed. It is represented by the letter Q and its measurement unit is kilovolt-ampere reactive (**kVAR**). It represents a measure of the stored energy reflected to the source which does not do any useful work.
- Real and reactive power are out of phase by 90°, and their vector sum is apparent power. It is represented by the letter S and its measurement unit is kilovolt-ampere (**kVA**).

The following diagram illustrates the concept of power factor:

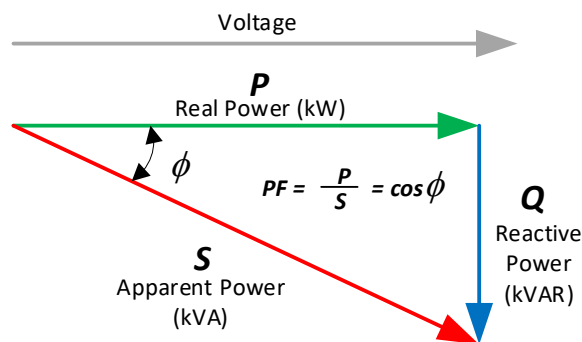

Figure 3.9 – Power factor graphical representation.

For instance, if we have 40 kW of real power and 15 kVAR or reactive power, the apparent power would be:

$$S = \sqrt{P^2 + Q^2} = \sqrt{(40\text{kW})^2 + (15\text{kVAR})^2} = 42.72\text{kVA}$$

In this scenario, the power factor would be:

$$PF = \frac{40 \text{ kW}}{42.72 \text{ kVA}} = 0.9363 = 93.63\%$$

If the load is predominantly inductive, the power factor is considered lagging. On the other hand, capacitive loads have a leading power factor.

B. Importance of power factor and PFC in the context of SSE

It is important to understand the nature of the different power fractions when determining the need for power factor correction. As indicated above, reactive power is not responsible for producing any useful work. It plays however an important role in the ability for a system to produce work.

Whilst active power is used directly in the production of mechanical, light, or thermal energy, reactive power is used to generate the flow necessary for the conversion of powers through the electric or magnetic field and it is index of the transfer of energy between supply and load. Without this, there could be no net transfer of power, for example, thanks to the magnetic coupling in the core of a transformer or in the air gap of a motor.

There are three main problems associated with low power factor (or the presence of reactive power) in a load:

- **Voltage drop** - The reactive component of current causes unwanted voltage drop that affects the regulation at the load.
- **Excess current** - As the triangle relationships in Figure 3.10 demonstrates, kVA decreases as power factor increases. At 70% power factor, it requires 142 kVA to produce 100 kW. At 95% power factor, it requires only 105 kVA to produce 100 kW. Another way to look at it is that at 70% power factor, it takes 35% more current to do the same work.
- **Efficiency** (and cost of energy supply) - The reactive current also generates additional heat loss in the connecting lines and for this reason the supplier will typically impose limits on the load power factor by imposing an additional cost premium on low power factor loads. In its most general form this will be by way of a charge on the peak kVA requirement of a load so that reduction of the kVA by reduction of power factor is an economic proposition for the customer.

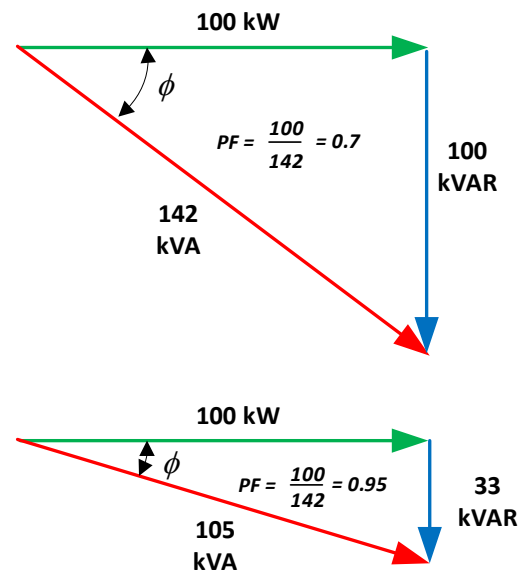

Figure 3.10 – Typical power factor triangles.

PFC aims to improve power factor, and therefore power quality. It reduces the load on the electrical distribution system, increases energy efficiency and reduces electricity costs. It also decreases the likelihood of instability and failure of equipment.

Power factor correction is obtained via the connection of capacitors which produce reactive energy in opposition to the energy absorbed by loads such as motors, locally close to the load. This improves the power factor from the point where the reactive power source is connected, preventing the unnecessary circulation of current in the network. Central PFC correction is also possible,

Several references point PF and PFC as being strictly related to billing reduction. This may be one of the key drivers when it comes to operational cost reduction. There is however an important relevance of PFC also to Safety as the reduction of current through the connections and cables also translates into less heat loss, improved cyclability and lifetime of transformer cores, amongst other important electrical gear.

A graphical representation of the PFC typical strategy for reactive power replacement is presented in Figure 3.11.

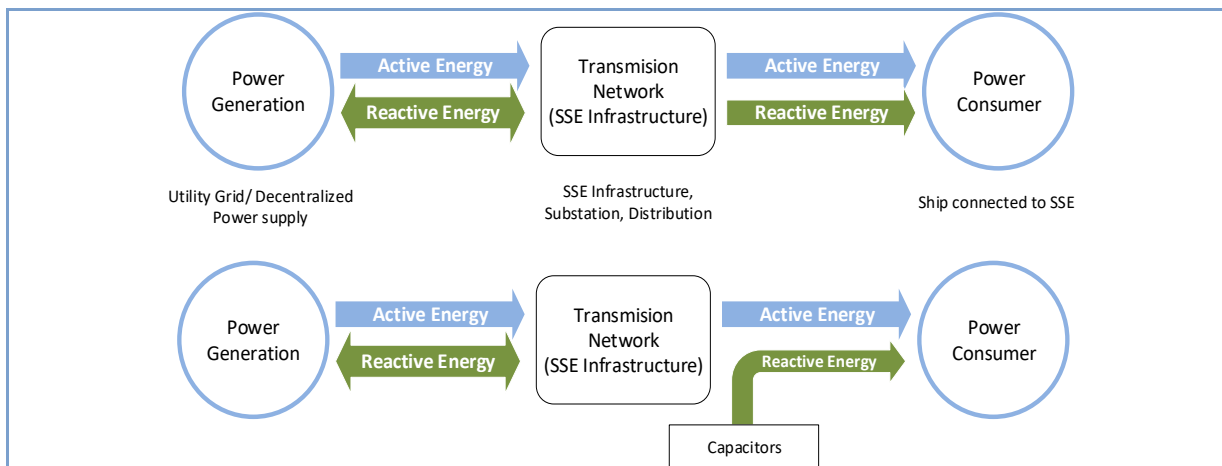

Figure 3.11 – Power Factor Correction strategy

Ships electrical load defines the power factor of the utilized power. Typically, the power factor of a ships grid is between PF=0.7 and PF=0.8 [12], which means that the power factor may be lower than defined in the electricity supply contract. Then the consequence is that vessel owner must pay extra on reactive power consumption (kVAR). This is sometimes very expensive, even ten times the price of efficient kW. Enhanced shore supply, providing for PFC should be considered in such cases.

The main contributors to ships' lower power factor are normally motor loads, which may include:

- Heating and cooling equipment
- Pumps and fans
- Compressors
- Hydraulic equipment

In residential buildings, these types of loads are minimal, so residential electric rates typically ignore power factor. However, this is not the case for ships, or port terminals, where the loads onboard vary significantly, both in magnitude and type.

Normally, the minimum power factor is defined by the electric utility company, as per contract defined with the SSE Facility Organization, Terminal or PAA.

- A minimum power factor may be required, for example 90%.
- Alternatively, the reactive power (kVAR) may be capped in function of the real power (kW). For example, an electric company might bill consumers whose reactive power exceeds 40% of real power (this would correspond to power factors below 92.85%).

In either billing approach, the fee paid by the consumer increases as power factor decreases - the bill may rise considerably in the case of large consumers.

The importance of PFC is justified. But to whom is PFC important? In the case of SSE energy supply PFC is important for everyone:

- **Ships:** as end user of electrical power supplied by SSE Facility Organization, Ships will pay, to the SSE Facility Organization, the energy consumed at the agreed rate. This may be:
 - A daily/hourly capacity rate per kW peak (€/kW/day, hour)
 - A daily/hourly capacity rate per kVA peak (€/kVA/day, hour)

Ships may have PF improvement at the load, taking the responsibility to ensure that energy paid for includes the best PF possible, with reduced amounts of reactive power.

- **SSE Facility Organization (SSE FO):** Considering Ships as the load point to whom SSE power is supplied, the energy bill paid by the SSE FO to the Utility energy supplier will be fractioned by the different consumers/ ship connection supplies. This means that, in practice the electricity bill paid by the SSE FO will be passed to the end-consumers (with possible service surplus).

With the above in consideration, it is possible to conclude that, in principle, ships are interested in PFC for reduced SSE energy bill and improved efficiency of electrical systems, whilst SSE FOs will be interested in reducing direct utility billing, allowing energy prices to be more competitive to end-users.

c. How to determine PFC required

The basic principle of power factor correction is to make inductive and capacitive loads balance each other. For instance, a motor (resistive-inductive load) drawing 10 kVAR of reactive power and a capacitor (capacitive load) rated at 8 kVAR will only draw a net reactive power of 2 kVAR. This is the reason why electric utility customers install capacitor banks to correct power factor. The adequate kVAR rating of the capacitor bank will depend on the load and the billing method.

Determining PFC required may follow 3 possible approaches, each deriving in different ways of calculation PFC:

1. Fixed Requirement
2. Cost savings
3. Loss Reduction

1. Fixed Requirement

Power Factor Correction: Minimum Value Requirement

In this scenario, it is simply a matter of calculating the actual power factor, and the kVAR difference that would be required to drive it above the minimum. For instance, consider the following inductive load:

$$P = 100 \text{ kW}$$

$$Q = 70 \text{ kVAR}$$

$$S = 122 \text{ kVA}$$

$$PF = 100\text{kW} / 122 \text{ kVA} = 0.8192 \text{ (81.92\%)}$$

If a minimum of 90% was required, apparent power would need to be:

$$S = P / 0.90 = 100 \text{ kW} / 0.90 = 111.11 \text{ kVA}$$

$$S = \sqrt{P^2 + Q^2}$$

$$Q = \sqrt{S^2 - P^2} = \sqrt{(111.11\text{kVA})^2 - (100\text{kW})^2} = 48.43\text{kVAR}$$

This means that the capacitor bank must have a minimum capacity of:

$$Q \text{ (capacitor)} = 70 \text{ kVAR} - 48.43 \text{ kVAR} = 21.57 \text{ kVAR}$$

Power Factor Correction: Percentage of Real Power Cap

Calculation is much simpler in this scenario. Consider the same example and a reactive power cap of 40% of real power.

$$Q \text{ (max)} = 100 \text{ kW} \times 40\% = 40 \text{ kVAR}$$

$$Q \text{ (actual)} = 70 \text{ kVAR}$$

$$Q \text{ (capacitor)} = 70 \text{ kVAR} - 40 \text{ kVAR} = 30 \text{ kVAR}$$

Capacitors are normally oversized by a slight margin, in order to exceed the minimum requirements of electric utility companies.

2. Cost Savings

Electric utility provides working (kW) and reactive power (kVAR), in our case to the SSE plant in the form of apparent power (kVA). While reactive power (kVAR) doesn't register on kW demand or kW hour meters, the utility's transmission and distribution system must be large enough to provide the total power. Utilities have various ways of passing the cost along to the end-user/customer. As shown in the following case examples, capacitors contribute to cost-savings, no matter how the utility billing is being made/issued.

kVA Billing

Example:

Assume an uncorrected 460 kVA demand, 480V, three-phase at 0.87 power factor.

Billing is provided for a €4.75/kVA demand.

How much would be the operational cost saving from increasing to PF = 0.97?

How long would it take to pay-off the investment in reactive power correction?

kVA × power factor = kW

460 × 0.87 = 400 kW actual demand

To calculate kVA from:

$$PF = \frac{P(kW)}{S(kVA)}$$

For PF=0.97

$$S = \frac{P}{PF} = \frac{400}{0.97} = 412$$

S = 412kVA

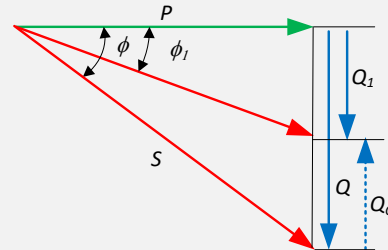

To raise the power factor from 0.87 to 0.97 it is now necessary to determine the rating of the capacitor(s) to install:

Q_c can be determined from the formula (refer to the diagram)

$$Q_c = P(\tan \phi - \tan \phi_1)$$

Where:

Q_c = power of the capacitor bank in kVAR

P = active power of the load in kW

tan φ = tangent of phase shift angle before compensation

tan φ₁ = tangent of phase shift angle after compensation

To determine φ and φ₁

$$\phi = \cos^{-1} 0.87 = 29.5 \text{ deg}$$

$$\phi_1 = \cos^{-1} 0.97 = 14 \text{ deg}$$

To calculate Q_c

$$Q_c = 400(\tan 29.5 - \tan 14) = 400(0.566 - 0.249) = 126.8 \text{ kVAR}$$

For practical reasons round up (considering 20kVAR units) – use 140kVAR

Corrected new billing: 412 kVA × €4.75 = €1957/month

140 kVAR, 480V capacitor cost: \$1600 (installation extra) [13].

The investment cost in this capacitor is recovered in less than 8 months.

kW demand billing with power factor adjustment

The utility charges according to the kW demand and adds a surcharge or adjustment for power factor. The adjustment may be a multiplier applied to kW demand. The following formula shows a billing based on 90% power factor:

$$\frac{\text{kW demand} \times 0.90}{\text{actual power factor}}$$

If power factor was 0.84, the utility would require 7% increase in billing, as shown in this formula:

$$\frac{\text{kW} \times 0.90}{0.84} = 107 \text{ (multiplier)}$$

Example

Assume a 400-kW load, 87% power factor with the following utility tariff:

First 40 kW @ €10.00/kW monthly billing demand

Next 160 kW @ €9.50/kW

Next 800 kW @ €9.00/kW

All over 1000 kW @ €8.50/kW

Power factor clause: Rates based on power factor of 90% or higher. When power factor is less than 85%, the demand will be increased 1% for each 1% that the power factor is below 90%. If the power factor is higher than 95%, the demand will be decreased 1% for each 1% that the power factor is above 90%.

There would be no penalty for 87% power factor. However, a bonus could be credited if the power factor were raised to 96%.

To raise an 87% power factor to 96%:

$$Q_c = P(\tan \phi - \tan \phi_1)$$

$$Q_c = 400(\tan(\cos^{-1} 0.87) - \tan(\cos^{-1} 0.96))$$

$$Q_c = 400(0.567 - 0.292) = 110 \text{ kVAR}$$

(Select 120 kVAR to ensure the maintenance of the 96% level)

To calculate savings

Normal 400 kW billing demand

Power supply	Rate	Sub-total
First 40 kW	€10.00	€400.00
Next 160 kW	€9.50	€1520.00
Bal. 200kW	€9.00	€1800.00
Total 400kW		€3720.00

New billing (PF adjusted billing)

$$\frac{\text{kW} \times 0.90}{\text{new power factor}} = \frac{400 \times 0.9}{0.96} = 375 \text{ kW demand}$$

Power supply	Rate	Sub-total
First 40 kW	€10.00	€400.00
Next 160 kW	€9.50	€1520.00
Bal. 175kW	€9.00	€1575.00
Total 400kW		€3495.00

kVAR reactive demand charge

The utility imposes a direct charge for the use of magnetizing power, usually a waiver of some percentage of kW demand. For example, if this charge were 60 cents per kVAR for everything over 50% of kW, and a 400kW load existed at the time, the utility would provide 200 kVAR free.

Example

Assume a 400kW load demand at 81% power factor.:

Demand charge is:

€635.00 for the first 200 kW demand

€2.80 per kW for all addition

Reactive demand charge is:

€0.60 per kVAR in excess of 50% of kW demand

In this example, kW demand = 400 kW, therefore 50% = 200 kVAR which will be furnished at no cost.

With the relations

$$\cos \phi = PF = \frac{kW}{kVA}$$

$$\tan \phi = \frac{kVAR}{kW}$$

For PF=0.81:

$$\cos \phi_1 = 0.81 = PF = \frac{400}{kVA}$$

Using the fundamental relation

$$1 + \tan^2 \phi_1 = \frac{1}{\cos^2 \phi_1}$$

$$\tan \phi_1 = \sqrt{\frac{1}{\cos^2 \phi_1} - 1} = \sqrt{\frac{1}{0.656} - 1} = 0.724$$

$$\tan \phi_1 = \frac{Q_1}{400} \rightarrow Q_1 = 289.6 \text{ kVAR}$$

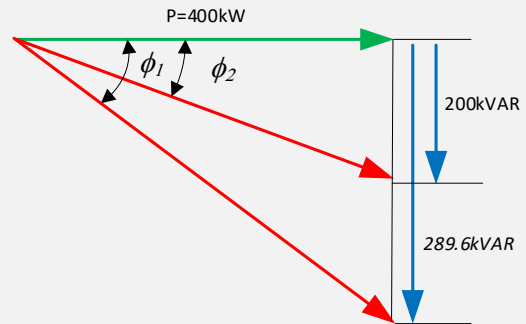

Because 200 kVAR is allowed, the excess kVAR is 89.6 (round to 90) x €0.60 = €54.00 per month billing for reactive demand.

With 200 kVAR allowed at no cost, then

$$\tan \phi_2 = \frac{kVAR}{kW} = \frac{200}{400} = 0.5$$

Using, again, the fundamental relation

$$1 + \tan^2 \phi_2 = \frac{1}{\cos^2 \phi_2}$$

$$\cos \phi_2 \cong 0.9$$

To correct 400 kW from 81% to 90%:

$$Q_c = P(\tan \phi_1 - \tan \phi_2) = 400(0.724 - 0.5) = 89.6 \approx 90 \text{ kVAR}$$

The approximate cost for this capacitor is €1250.00. The payoff is about 23 months.

Increased system capacity

Power factor correction capacitors increase system current-carrying capacity. Raising the power factor on a kW load reduces kVA. Therefore, by adding capacitors, you can add additional kW load to your system without altering the kVA.

Example

A plant has a 500kVA transformer operating near capacity. It draws 480 kVA or 578A at 480V. The present power factor is 75%, so the actual working power available is 360 kW.

It is desired to increase production by 25%, which means that about 450 kW output must be obtained. How is this accomplished?

A new transformer would certainly be one solution. For 450 kW output, the transformer would be rated at 600 kVA to handle 75% power factor load. More likely, the next size standard rating would be needed (750 kVA).

Perhaps a better solution would be to improve the power factor and release enough capacity to accommodate the increased load.

To correct 450 kW from 75% to 95%:

$$Q_C = P(\tan \phi - \tan \phi_1)$$

$$Q_C = 450(\tan(\cos^{-1} 0.75) - \tan(\cos^{-1} 0.95))$$

$$Q_C = 450(\tan 41.4 - \tan 18.2) = 248.8 \text{ kVAR}$$

(use 250 kVAR at about €2800.00).

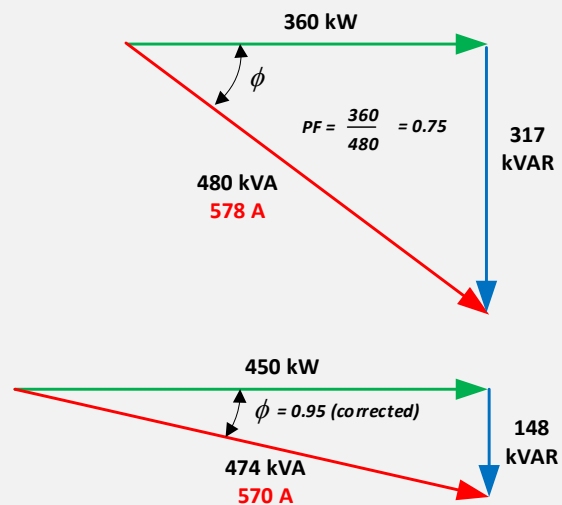

The same principle holds true for reducing current on overloaded facilities. Increasing power factor from 75% to 95% on the same kW load results in 21% lower current flow. Put another way, it takes 26.7% more current for a load to operate at 75%, and 46.2% more current to operate at 65%.

3. Loss Reduction

The other savings benefit that comes with power factor correction occurs with the reduction of losses in the feeder connections. The per unit reduction in ohmic (I^2R) loss due to reduction of line current is:

$$PU_{loss\ reduction} = 1 - \left(\frac{PF_{old}}{PF_{new}}\right)^2$$

Typically, line losses are about 3–7% of total load power usage. Any reduction of the 3–7% will give substantial benefit if the load power consumption is high.

In addition to the evaluation of the efficiency gains, related to the loss reduction, also the safety aspects related to reduced current through conductors and terminals is an aspect to consider. Safety devices should be considered for the new corrected connection supply.

Example

A 1000 kW load is operated for 60 hours per week from a 415V supply with 7% loss in the supply lines. The load PF is 0.75 and the energy charge is \$0.10 per kWh. What are the cost benefits of increasing PF to 0.95?

If the load power factor is increased to 0.95, the loss improvement is:

$$PU_{loss\ reduction} = 1 - \left(\frac{0.75}{0.95}\right)^2 = 0.377 = 37.7\%$$

Thus, the new losses are $0.623 \times 7\% = 4.36\%$

Old kWh loss per week was: $0.07 \times 1000 \times 60 = 4200$ kWh

Energy cost was $4200 \times \$0.1 = \420 per week

New kWh loss per week: $0.0436 \times 1000 \times 60 = 2618$ kWh

Energy cost is now $(2618) \times \$0.1 = €261.8$ per week

Saving is $420 - 261.8 = \$158.2$ per week or €8,226 per annum. [€685.5 /month]

For PF = 0.75, S = 1333 kVA, Q = 882 kVAR

For PF = 0.95, S = 1053 kVA, Q = 329 kVAR

Thus, need $882 - 329 = 553$ kVAR of installed capacitance. If the cost of the capacitors is €20/kVAR, installation cost is €11,060. Time to achieve cost recovery is $11,060 / 686 = 16.1$ months.

D. Best practice in SSE PF implementation

As mentioned above, typically the reference PF of SSE connected ships is between PF=0.7 to PF=0.8. Depending on the SSE, FO electrical power source, and billing contract, there will be a clear opportunity to improve the power factor, resulting in clear gains primarily for the SSE FO and, down the line, also to ships.

The selection of PFC equipment should be done according to the following four-step process, by selected individuals/companies with demonstrated competence/experience in electrical engineering:

Step 1: Calculation of the required reactive power

The objective is to determine the required reactive power (Q_c (kVAR)) to be installed, to improve the power factor ($\cos \Phi$) and reduce the apparent power (S)

Q_c can be determined from the formula

$$Q_c = P (\tan \Phi - \tan \Phi_1)$$

which is deduced from the diagram to the right.

Q_c = power of the capacitor bank in kVAR

P = active power of the load in kW

$\tan \Phi$ = tangent of phase shift angle before compensation

$\tan \Phi_1$ = tangent of phase shift angle after compensation

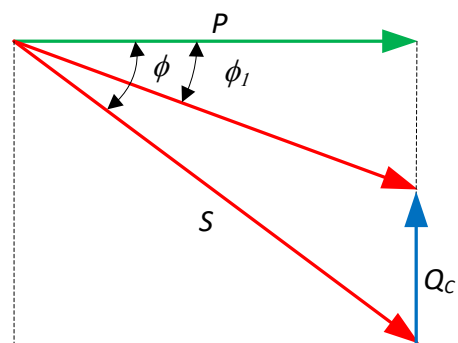

The parameters Φ and $\tan \Phi_1$ can be obtained from billing data, or from direct measurement in the installation.

Step 2: Selection of the compensation mode

The location of low-voltage capacitors in an installation can either be central (one location serving all berth connections), or at berth (at berth-module switchboard). Correction at load level, onboard, is not considered in the present best-practice procedure which is primarily addressed for the shore side.

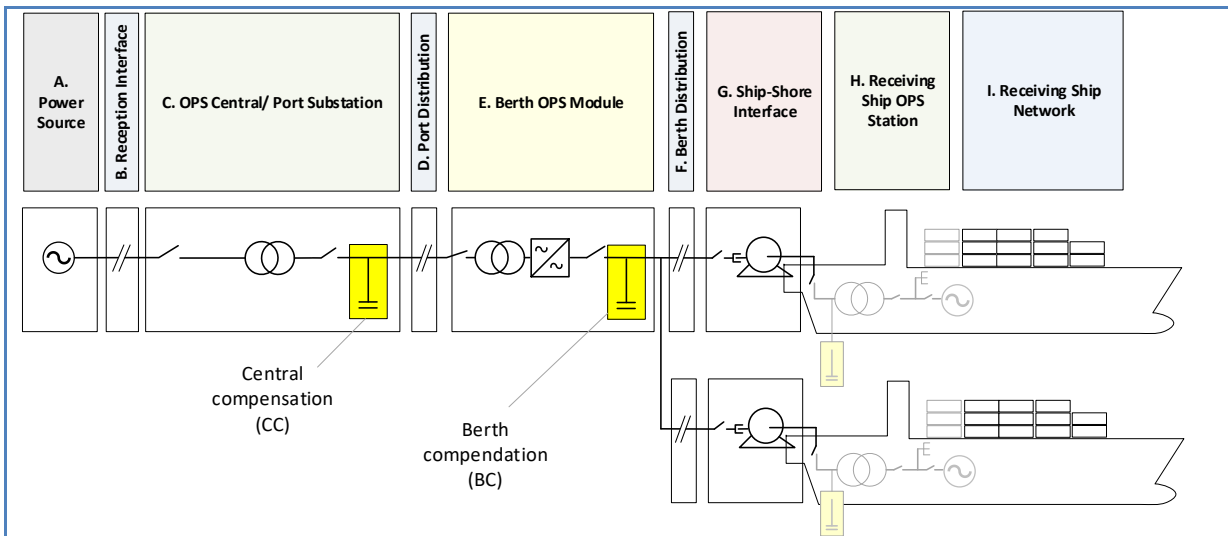

Figure 3.12 – Selection of compensation mode – level for capacitor module installation

In principle, the ideal compensation would be applied at a point of consumption and at the level required at any moment in time. In practice, however, and for the case of SSE, this is not always possible to guarantee, and a central dynamic compensation solution should be preferred and carefully considered by PAA.

Important aspects to also consider in the selection:

- the overall objective (avoiding penalties on reactive energy, relieving transformers or cables, avoiding voltage drops and sags)
- the operating mode (stable or fluctuating loads)
- the foreseeable influence of capacitors on the SSE grid network characteristics
- the installation cost

Step 3: Selection of the compensation type

Different types of compensation should be adopted depending on the performance requirements and complexity of control:

- Fixed, by connection of a fixed-value capacitor bank
- Automatic, by connection of a different number of steps, allowing adjustment of the reactive energy to the required value
- Dynamic, for compensation of highly fluctuating loads.

Step 4: Allowance for operating conditions and harmonics

Operating conditions have a great impact on the life expectancy of capacitors, so the following parameters should be considered:

- Ambient temperature (°C)
- Expected over-current related to voltage disturbances, including maximum sustained overvoltage
- Maximum number of switching operations per year
- Required life expectancy

Some loads (variable speed motors, static converters, welding machines, etc.) pollute the electrical network by reinjecting harmonics. It is therefore also necessary to consider the effects of these harmonics on the capacitors.

E. Available equipment for Power Factor Correction

Essentially two different types of equipment can provide PFC to the desired level in a power supply circuit:

- Capacitors, Capacitor banks, including dynamic capacitors (Figure 3.13)
- Static VAR Generators (SVG) – (Figure 3.14)



Figure 3.13 – Capacitor bank.

Being by far the option most widely used, economic and proven power capacitor units can be rated as follows:

- Nominal system voltage in KV.
- System power frequency in Hz.
- Temperature class with allowable maximum and minimum temperature in degrees C°.
- Rated voltage per unit in KV.
- Rated output in KVAR.
- Rated capacitance in μF .
- Rated current in Amp.
- Rated insulation level (Nominal voltage/Impulse voltage).
- Discharge time/voltage in second/voltage.
- Fusing arrangement either internally fused or externally fused or fuseless.
- Number of bushing, double/single/triple bushing.
- Number of phases. Single phase or three phased.



Figure 3.14 – Static VAR generator (SVG).

Static VAR generators (SVG) offer several advantages in comparison to capacitors:

- Ability to compensate both inductive and capacitive load.
- Dynamic stepless compensation (capacitors are switched in module capacitance units, while SVGs can adjust reactive current with a fast response speed) – This is a particular characteristic which can be very convenient for SSE.
- Not affected by resonance

3.1.1.4 Metering

Metering is a function presented with relevance in the context of power quality. Metering is related with two other concepts which should be mentioned for clear disambiguation: 1) measurement and 2) recording. Both are important concepts to be invoked and, whenever mentioning “metering” in the present Guidance it should be understood as “measurement” and “recording”. In fact, despite the specific differences between all the concepts, it is important to ensure that both continuous measurement and historic record-keeping of selected power quality parameters is considered and well defined in all SSE supply services.

Metering of supplied electricity should be provided for the purpose of:

- Electrical/power quality analysis
- Electrical energy custody transfer
- Energy consumption for billing and/or energy efficiency purposes.
- Verification of contract obligations/provisions regarding the quantity and quality of electrical energy supplied.

- Production of evidence-based records for support of possible disputes/claims.
- Production of relevant data which can be used for engineering decision-making and/or risk assessment calculations based on up-to-date statistics.

The boundary for the responsibility of the electricity supplier should be defined by both parties in the contract (PAA/terminal, ship/fleet owner/operator). Contracted power, maintenance supply interface should be guaranteed by the energy supplier.

Energy and power data loggers should be used to measure and record power consumption and quality. They can be used to meet requirements from both energy supply and demand sides. At Port level, these can be used in accordance with the network architecture. These devices monitor and record different electrical parameters that can include volts, amps, watts, volt-amps (VA), volt-amps reactive (VAR), kilowatts (kW), kilowatt hours (kWh), power factor and harmonics.

Technology for metering of electrical power quality is fundamental to ensure adequate accuracy, reproducibility, operation, and readability of target data. Fixed modular electronic power quality analysers are currently a common option to integrate different SSE switchboards (Figure 3.15).

It may be considered to make use of an integrated system with multiple data acquisition such as the one presented in the diagram of Figure 3.16, supported by adequate communication layout and infrastructure and computer dedicated software.



Figure 3.15 – Modular power quality analyser. Modular power analysers are typically used integrated in switchboards and prepared to provide monitoring information on different selected parameters.

Source: Janitza electronics GmbH

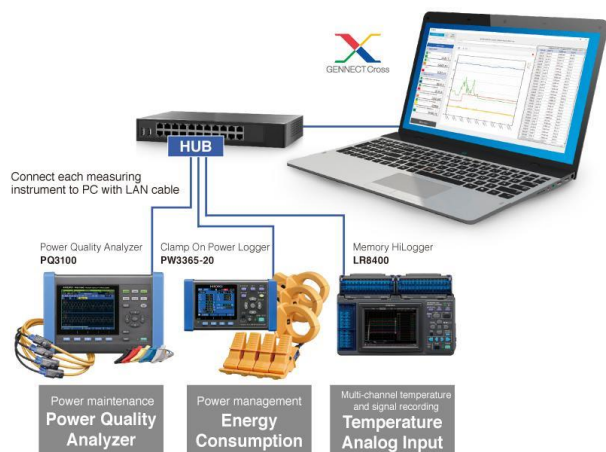

Figure 3.16 – Integrated data acquisition setup for multiple entry power quality analysis. Pre-selected parameters for power quality monitoring.

Source: Hioki USA

The relevant parameters for metering/utility supply contract should be agreed in advance to the contract. With kWh typically designed as the billing parameter, there may be other parameters which are important to monitor for quality assurance. These need to be identified and well defined for metering purposes.

Metering and measurement can be implemented for SSE projects under different applications. Whilst suppliers of electrical energy will be interested in power quality and billing, the Ports should see metering and measurement as tools for bill checking, power quality analysis and/or energy efficiency monitoring.

Power generation, transmission, and distribution are typically grouped in the **supply side of energy**. Within this side, there are two main categories of contractual applications:

- Billing
- Grid power quality

The port side represents the **demand side** of energy. For these users, electrical system designers must specify solutions within three categories of application:

- Cost allocation, bill checking and sub-billing

- Energy efficiency and cost savings, energy usage analysis
- Power availability and reliability, network monitoring

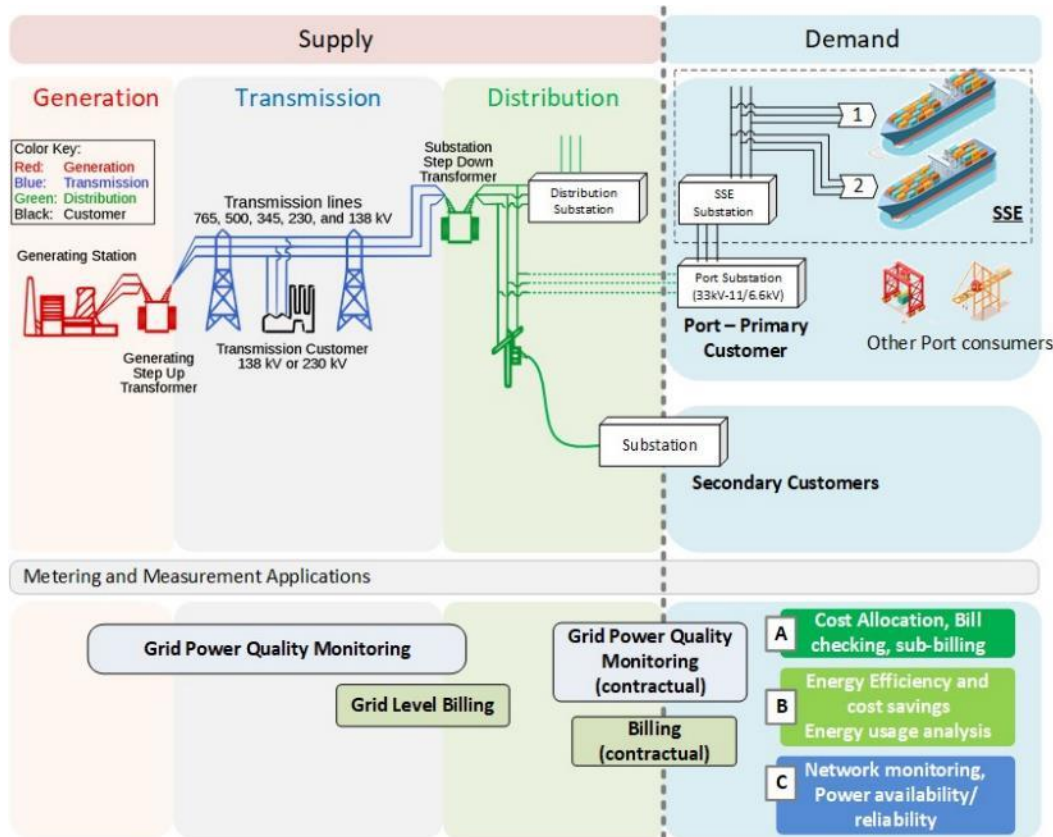

Figure 3.17 - Categories of measurement applications on the supply side and demand side.

Source: EMSA

The different applications of metering, measurement and power quality monitoring should be combined and integrated to mitigate the risks of low power quality and reliability. Whilst transparency in billing and contractual obligations remains as a key objective of metering and measurement, it is also important to ensure that power quality is identified by both energy supplier and PAA as a fundamental instrument in support of safety and energy security.

Ports are often complex areas with a variety of different terminals and services co-existing and contributing to the port operational environment. SSE supply to different services may be done either directly from utility grid supply or under a sub-contract directly with the respective PAA. A third option, not involving the utility grid may be considered, with self-generated power, either at port or terminal level.

Contractual aspects are outside the present Guidance, nevertheless the energy custody transfer is a key relevant concept directly related to liability, energy security and electrical safety aspects. All electrical energy supply contracts must include clear indication of custody transfer aspects, including clear division of responsibilities.

Achieving power reliability, energy efficiency, and operational cost goals, whether on the utility grid or within the SSE facility, requires a strong strategy with respect to metering and power quality applications. A complete measurement plan is needed, covering the relevant SSE applications, and supported by power metering and monitoring devices (PMDs) that provide the required measurements.

Table 3.5, includes reference to the different possible applications, considered potentially relevant for Ports and SSE facilities [14].

Table 3.5 - Metering/measurement applications. Basic definitions as potentially relevant in SSE projects, metering/ measurement devices and international/European references for certification [14].

Application	Definition	Relevance in SSE	Device	Standard
Billing	The process that allows energy suppliers or their representatives to invoice their customers according to a defined contract, for measured energy usage	Billing is relevant in the case of utility grid supply to the Port or in case of any decentralized power production where energy is supplied to the port grid.	Revenue meter, utility meter, electricity meter, billing meter or legal metrology applications	MID (Measuring Instruments Directive) EN 50470
Sub-billing (fraction-metering)	Sub-billing or sub-metering The process that allows an organization to spread out invoice over fractions or sub-customers (assigning portions of energy invoice to each separate fraction), for measured usages or services.	PAA may have in sub-billing, or sub-metering, a process which allows the billable energy supplied to the port to be distributed by the end-users. These may consist of SSE infrastructure or any other main primary/secondary energy consumers, if organized in a legal entity/company/organization other than the port administration. This is particularly important when ports are organized	Legal tenant meter or legal sub-meter (for legal metrology applications)	If MID applies EN 50470 IEC 61557-12 (C-PMD1, i.e., with active energy independently certified, covered by manufacturing audits, meeting measurement durability requirements and providing an indication of manufacturing date for periodic verifications)
Bill checking	The process that allows customers to check if invoice sent by energy suppliers or their representatives is correct.	Bill checking is primarily relevant for all energy consuming organizations, in order to verify the energy invoice and, above all, to promote transparency at the point of energy custody transfer.	Power meter	IEC 61557-12 (C-PMD1, i.e., with active energy independently certified, covered by manufacturing audits, meeting measurement durability requirements and providing an indication of manufacturing date for periodic verifications)
Cost allocation	The process that allows a facility manager to allocate energy costs to internal cost centres that consume energy (e.g., plants, workshop ...)	Ports may implement cost allocation procedures in order to have a distribution of energy supplied by end-user consumers, including SSE infrastructure, terminals, and other primary/secondary energy user centres.		IEC 61557-12 (PMD1)
Energy efficiency	The process that allows a facility manager to assign energy consumption/costs to zones (plant, floor, workshop...) and to usages (HVAC, lighting, appliances, process...) over the time to allow optimization of energy consumption and energy costs.	Energy efficiency is a key application supporting the understanding of the electrical energy consumption throughout the wider port area, over the time. Performance of SSE systems, being expected to constitute large peak consumers, is an important aspect to consider. Energy efficiency should be clearly constituted as a performance indicator for SSE infrastructure.	Power meter	ISO 50001 Energy Management System – Requirements with guidance for use ISO 50006 Energy Baseline (EnBs) & Energy Performance Indicators (EnPIs) IEC 60364-8-1 Low voltage installations – Part 8-1: Energy Efficiency FD X30-147 Measurement plan for energy performance monitoring

				<p>Power Meters IEC 61557-12 Power Metering and monitoring devices (PMD)</p> <p>Gateways, energy servers, data loggers IEC 62974-1 Monitoring and measuring systems used for data collection, gathering and analysis – Part 1: Device requirements</p>
Grid power quality monitoring	The process that allows energy suppliers and/or their customers to verify the quality of energy delivered/received is in line with a defined contract or regulation.	<p>Power quality monitoring is relevant for SSE infrastructure with a two-fold objective:</p> <ol style="list-style-type: none"> 1. Ensure quality of the energy supplied 2. Provide evidence that SSE electricity supply meets IEC/ IEEE 80005 series electrical power quality requirements. <p>Contractual aspects are important and should include the relevant power quality requirements.</p> <p>Utility grid supplier is liable for power quality supplied as per contract and regulatory framework, to the PAA. PAA, when operating as energy supply intermediary, is liable for the power quality supplied.</p>	Power quality instrument	<p>Power quality reference for SSE: IEC/IEEE</p> <p>Power quality instrument Relevant product embedding IEC 61000-4-30 class A functions (tested according to IEC 62586-2)</p>
Network monitoring	The process that allows a facility manager to monitor its electrical installation to ensure availability and reliability of energy as well as asset durability.	Availability and reliability are essential	Analog electrical measuring instrument	IEC 60051
			Power meter	IEC 61557-12 (PMD2 or PMD3)
			Class S power meter	IEC 61557-12 (PMD3) embedding IEC 61000-4-30 class S functions (tested according to IEC 62586-2)

NOTES to Table 3.5:

1. Some devices are providing qualitative data, resulting from reduced acquisition performance or from simplified calculation algorithms. These approximate values are used for indication (e.g., current flowing or not), comparison (e.g., significant variation in consumption of an equipment between two time-periods) or estimation (e.g., low level of Power Factor) and cannot be compared to measurements provided by the above devices.
2. Depending on the measurement or monitoring application, different types of power PMDs must be used. Compliance with relevant standards will ensure that PMDs are reliable, measurements are accurate, and data can be trusted.
3. Most measurement or monitoring applications in electrical systems can be covered by PMDs complying with the IEC 61557-12 standard and by power quality instruments complying with the IEC 62586 standard, as summarized in table 10.
4. IEC 61000-4-30 provides the following definitions:
 - Class A: This class is used where precise measurements are necessary, for example, for contractual applications that may require resolving disputes, verifying compliance with standards, etc.
 - Class S: This class is used for statistical applications such as surveys or power quality assessment, possibly with a limited subset of parameters.

As referred in Table 3.5 the different metering and measurement applications serve different objectives. Legal and contractual obligations are verified by certified equipment. Other applications, such as network monitoring, involve also certified equipment, having however an objective of quality assurance, statistical data treatment in support to energy reliability and security.

Considering the different metering/measurement applications, the relevance of all the different functionalities, and the complexity of the typical network grid environment of a maritime port, it is important to have a clear distinction of the different integrated functionalities for power monitoring systems. Figure 3.18, presents a few of these key functionalities for a power quality monitoring diagram. The example presented, strictly for demonstration, includes 3 power monitoring digital modular meters (satellite units), capturing signal data from utility grid electrical supply, main SSE substation output and at berth module level.

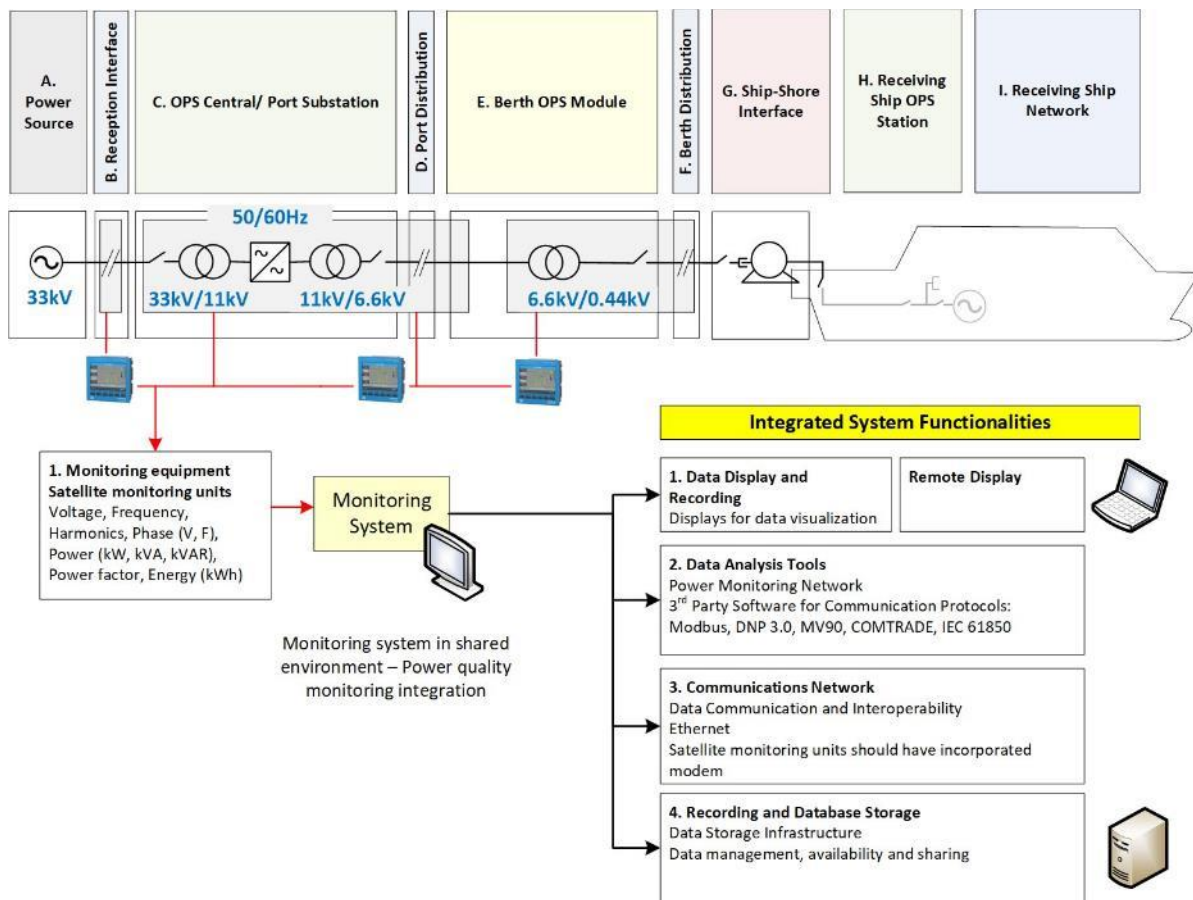

Figure 3.18 - Grid integration for power quality monitoring – Main functionalities for power monitoring systems.

Source: EMSA

With ports consisting of typical complex environments, with several companies and legal entities operating within the wider port area jurisdiction, the electrical energy management in the port area is an also complex activity which involves the up-to-date information and estimates on electrical usage and power demand, depending the different areas of the port and the associated aggregated activities. Whilst SSE may consist of a strong peak energy consumer, it will also have a highly variable load profile, with several berth positions not used for large periods of time. Designing the grid monitoring systems requires however an energy measurement plan which is outreaching and all inclusive. If Utility grid is directly connected to SSE infrastructure the likelihood of grid interference or fluctuations induced by other port consumers (cargo, services, terminal operation, etc) is reduced. If, on the other hand, the SSE is withdrawing energy from port grid, with the port acting as intermediate energy supplier, this risk is not immediately mitigated and an integrated power monitoring system should be implemented, very likely where different stakeholders will have to share a common understanding regarding the criticality of having adequate online live information on the consumption patterns and electrical power quality of selected areas within the PAA jurisdiction.

Power Quality Monitoring Plans, integrating the different applications (Table 3.5) and power monitoring equipment functionalities (Figure 3.18) should reflect the actual infrastructure arrangement and the different areas within each specific port. Each port is a specific case, and the power quality monitoring plan should also reflect that singularity. While some ports may have more simplified organization, others, reflecting a large variety of possible port activities, may be internally separated into different Terminals and other service areas.

Metering (for any of the applications indicated in Table 3.5), measurement and monitoring should be made, primarily, where energy custody transfer occurs, for contractual, billing and liability purposes. Figure 3.19, illustrates the simplest case where PAA also takes the role of SSE FO, with no intermediary Terminal or Service Provider. Meter Boxes suggested at utility inbound connection and berth connection positions for sub-billing.

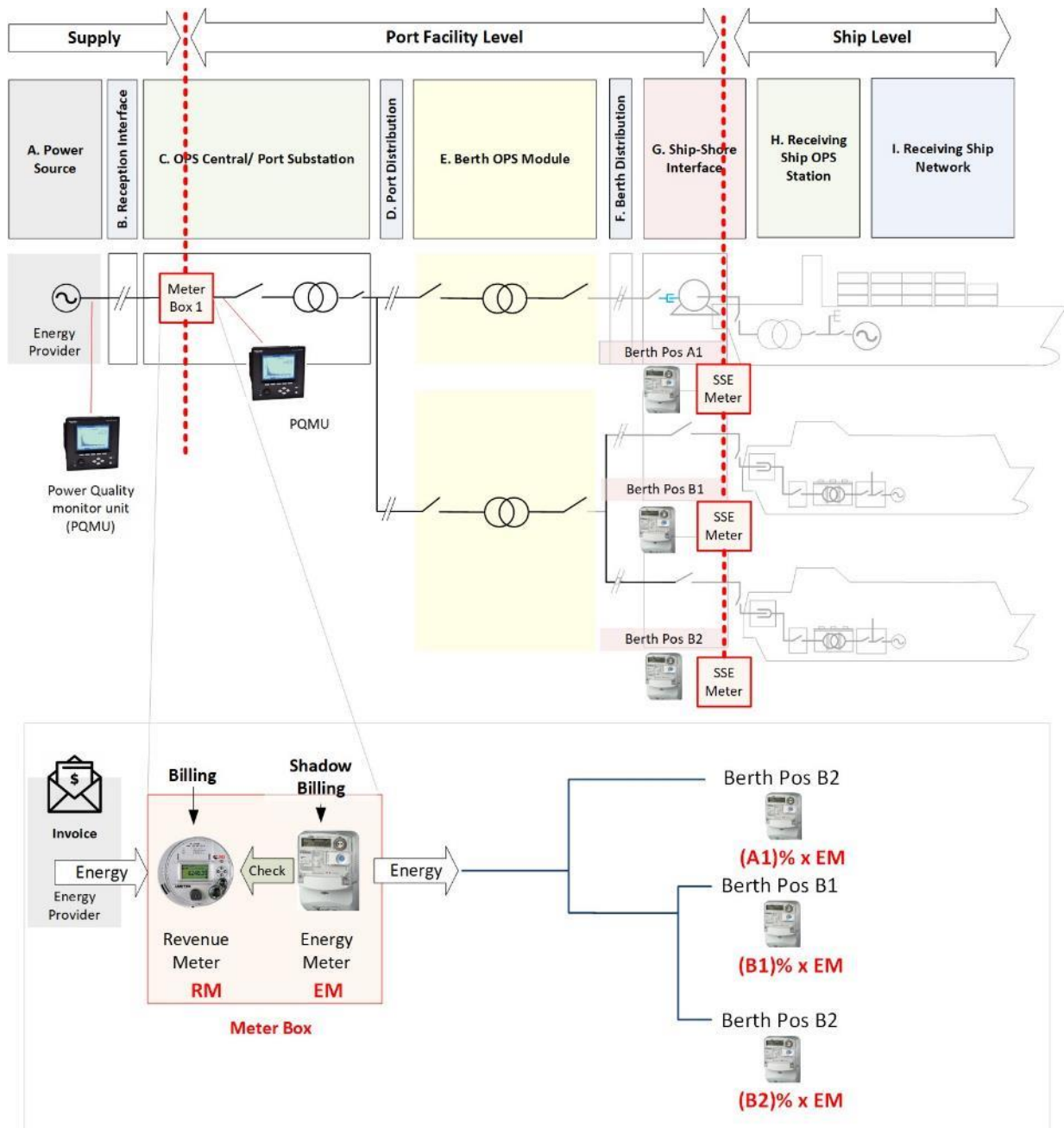

Figure 3.19 - Electrical Energy metering diagram – Example for Port direct supply to SSE.

Source: EMSA

With more energy custody transfer levels, when terminals or other intermediary SSE service providers are included in the mapping, the metering and power quality monitoring plan becomes more layered, with terminals (cargo, passenger, cars, etc) holding the energy supply as part of terminal organic services. To be noted here that SSE is integrated in port infrastructure and each level presented in Figure 3.20 coincides with an electrical energy custody transfer.

Metering boxes are indicated at the border of energy custody transfer. Power quality monitors, similarly, for contract, liability and even safety reasons, are placed at each layer (utility, port substation, terminals).

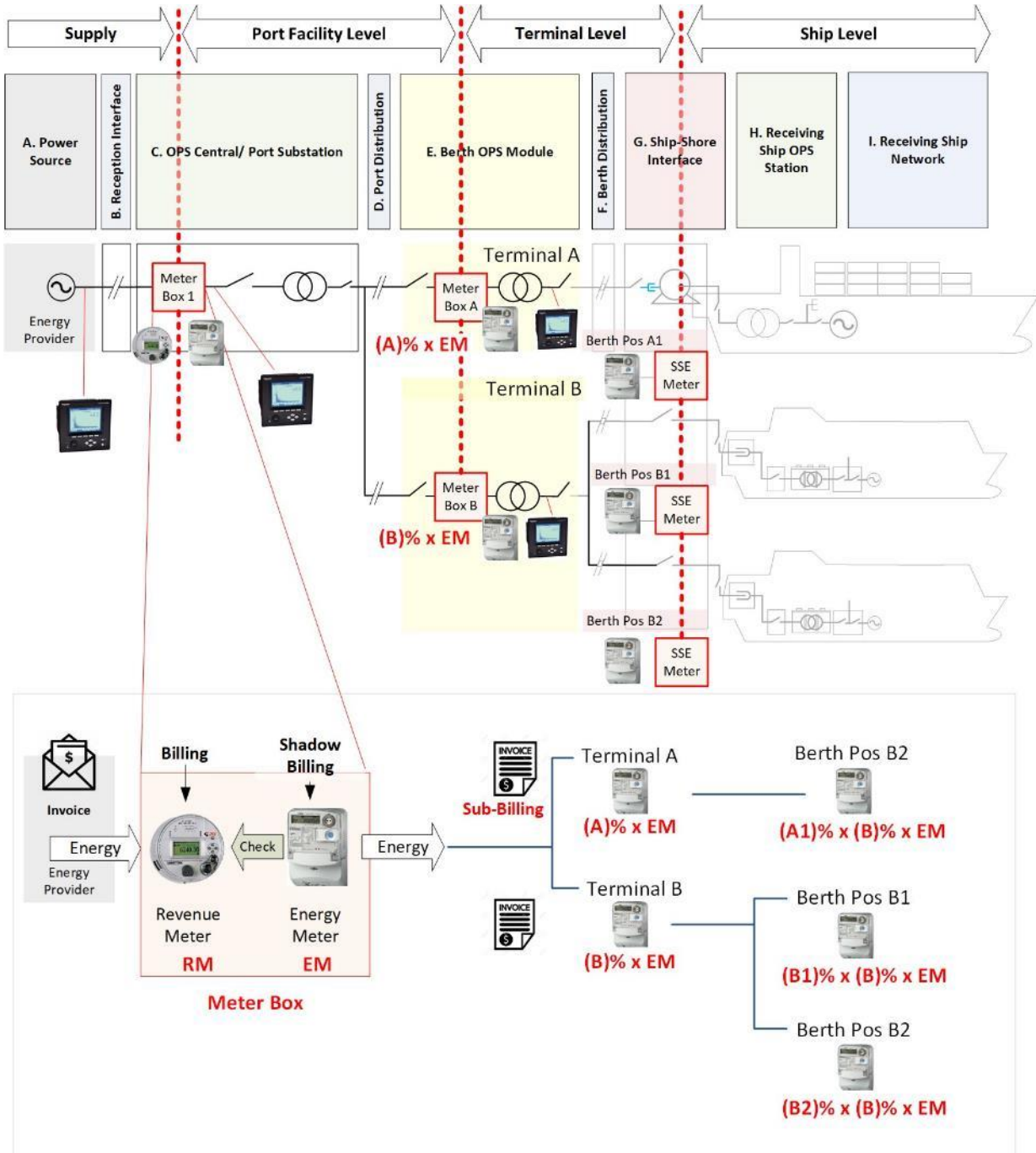

Figure 3.20 - Electrical energy metering diagram – Example for port indirect supply to SSE – Terminals integrated as sub-contracts for energy supply, within the port area.

Source: EMSA

A third possibility, other than the one presented in Figure 3.19 and Figure 3.20, would encompass a 3rd party service provider “SSE Facility Organization” which could manage the entire cross-layer energy infrastructure for SSE supply.

In addition, power generation could also occur at port level, either within a terminal or at the wider port area level. This would, in practice, coming from renewable power generation or from conventional means, represent decentralized power production. Constituting typically intermittent energy supply, with fluctuating quality parameters, it is even more important in those circumstances to have a robust power quality monitoring system that provides insight on the quality of the SSE energy supplied.

Power quality monitoring instruments are essential pieces of the power monitoring plan, providing the interface between the power/electrical grid and the data processing environment, and allowing for the sampling of a large variety of selected parameters, for the electrical energy, for each of the three phases and RMS. Depending on manufacturer and cost these devices will provide for a combination of relevant metering samples. Table 3.6, includes a sample list of possible electrical power parameters that may be captured by this equipment.

Table 3.6 Metering equipment – possible parameters for metering equipment.

Parameter group	Possible individual parameters to be measured
Energy	<ul style="list-style-type: none"> • kWh delivered and received • kWh, kVARh, kVAh net (delivered - received) • kWh, kVARh, kVAh total (delivered + received) • kVARh, kVAh delivered and received • Integration of any instantaneous measurement <p>All energy parameters represent the total for all three phases. Energy readings are true RMS.</p>
Demand	<p>The meters typically support standard demand calculation methods, including block, rolling block, and predicted demand. They can measure demand on any instantaneous value and record peak (maximum) and minimum demand with date and time-stamps to the second. Peak demand registers can be reset manually (password protected) or logged and reset automatically on a programmed schedule. Measurements include:</p> <ul style="list-style-type: none"> • kW, kVAR, kVA demand, min/max • Amps, Volts demand, min/max • Demand on any instantaneous measurement
Time log accuracy	<p>Meters provide a choice of high accuracy, 1 second or high-speed, 1/2 cycle measurements, including true RMS, per phase and total for:</p> <ul style="list-style-type: none"> • Voltage and current • Active power (kW) and reactive power (kVAR) • Apparent power (kVA) • Power factor and frequency • Voltage and current unbalance • Phase reversal or any relevant incidents.
Harmonics	<p>Complete harmonic distortion metering, recording and real-time reporting, for all voltage and current inputs.</p> <ul style="list-style-type: none"> • Individual harmonics (including magnitude, phase) • Total even harmonics and total odd harmonics • Total harmonics (even + odd) • Total interharmonics distortion • K-factor, Crest factor
Power quality	<p>Power quality meters will typically address most of the most common power quality conditions presented in Table 3.3 and Figure 3.8.</p>

3.1.1.5 Power Quality Data

An important challenge to be addressed by strategies and technologies for metering and measurement of electrical power are the large amount of data generated, its processing and storage.

Several types of instruments are today able to read and display electrical power waveforms and calculating parameters of the waveforms. These parameters may include, as listed in Table 3.6, current and voltage RMS, phase relationship between waveforms of a multi-phase signal, power factor, frequency, THD, active power (kW), reactive power (kVAR), apparent power (kVA) and active energy (kWh), reactive energy (kVARh) and apparent energy (kVAh) and many more.

To sufficiently monitor unforeseen events, it should not be enough to display these parameters, but to also capture voltage waveform data at all times. This is however deemed impracticable due to the large amount of data involved, causing a serious constraint. For example, AC power, consisting of tri-phasic AC electrical supply, generates a large amount of data. At 50/60 cycles/second, three-phases, an average connected 24hr ship stay at berth results in approximately $4.5 \times 3 = 13.5$ million cycles. For each cycle there are several relevant selected parameters.

The large amount of data is a challenge which will typically require strategies and solutions which, on one hand, are able to ensure the relevant capture and recording of the relevant data for power quality and supply continuity purposes whilst, on the other hand, is able to address the limitations on data storage.

Table 3.7 - Data capture and storage management options

Data capture and storage management	Description	Advantages/disadvantages
Discrete non-continuous data sampling and recording	Sampling of discrete data points, over a range of selected parameters. Sampling is either sampled at selected time interval over a given power supply period or defined in accordance with a set of thresholds, e.g., voltage % deviation allowance, harmonics % distortion, etc. The data size issue is here addressed by losing constant/regular data and sampling/storing only the "occurrences", with deviations from normal working parameters.	<u>Advantages:</u> <ul style="list-style-type: none"> • Simplicity • Lower requirement • Selected recording of power quality issues <u>Disadvantages:</u> <ul style="list-style-type: none"> • Loss of data • Unsuitable for big data analytics • Difficult to use for liability purposes
Roll-out data capture and storage followed by Raw Data compression	Data capture in continuous time intervals, at a specified sampling rate over the waveforms for the 3 phases. Following capture the data is processed by a compression algorithm. The algorithm allows for an increase of memory of a processor which is enabled to store the waveform, under normal power conditions, over a long period of time. The compression is performed in real time, as the signals are acquired; it calculates a compression decision before all the compressed data is received	<u>Advantages:</u> <ul style="list-style-type: none"> • No data is lost over the period of sampling (lossless data recording). • No data gaps <u>Disadvantages:</u> <ul style="list-style-type: none"> • Computational capacity required
Segment Aggregated data compression	Data captured in segments, according to defined periods of interest. Rolling data taken at a defined sampling rate is recorded and compressed in segments over well-defined periods. Instead of compressing the whole length of the waveform data, aggregated segments are created focused on specific time periods. Represents a lossless data recording strategy for specific intervals.	<u>Advantages:</u> <ul style="list-style-type: none"> • No data is lost over the intervals defined for sampling (lossless data recording). • No data gaps over the segment periods defined <u>Disadvantages:</u> <ul style="list-style-type: none"> • Computational capacity required. • Some data may be lost outside the periods of interest.

The minimum data storage requirements that PAA should define for SSE power quality data should be sufficient to store all connection periods, for every individual ship supplied with electrical energy, at any given SSE connection point within the port. To each ship connection should correspond one file, called "data files", as presented in Table 3.8. In the table it is possible to see 4 (four) berth positions, with their

daily SSE connection plan. For each connection one “data file” should be generated, allowing for adequate and complete traceability of the electrical power parameters for each specific supply.

Table 3.8 - Data packs for SSE power quality supply data.

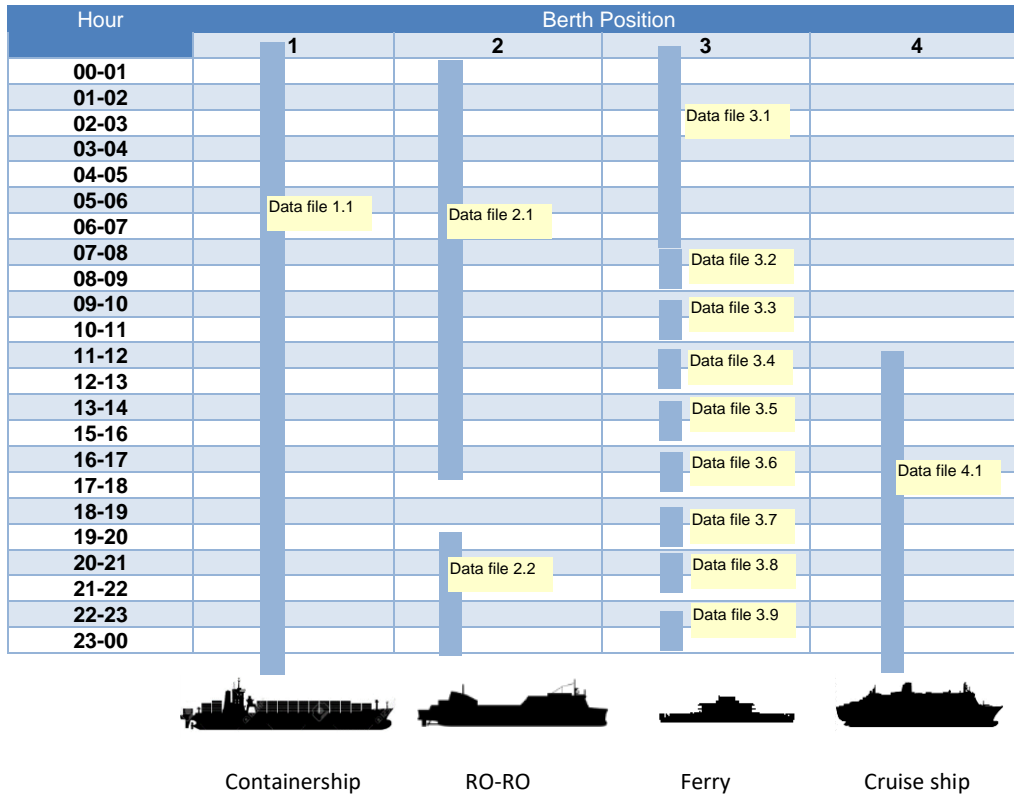

To each data file should correspond a minimum number of power quality parameters to be sampled, at a specified sampling rate, between connection and disconnection of any specific ship, in a continuous way.

The minimum set of parameters to be recorded in each Data File are:

- Parameters defined in Table 3.1, as applicable.
- Active and Reactive power parameters
- Harmonics, with a view to demonstrate harmonic quality control as per IEEE Std. 519-2014

Data compression strategy applied should result in no loss of data, within each data file, allowing for a complete reproduction of ship-specific SSE connections over the entire connection period at berth.

All data files related to on SSE installation should be time-stamped with half-cycle accuracy (i.e., for a 50Hz AC supply, a 100Hz sampling frequency should be provided for. It is important that all data files share the same time stamp, with the same reference.

For SSE infrastructure grids which share the same substation switchboards with other consumers it is important to have information from other supply points. Significant voltage variations at other consumer points have the potential to induce instability in the grid. This may be less relevant depending on the different power conditioning equipment installed

Characteristics, Metering and Quality of Electricity Supply - References and further reading:

- IEC/IEEE 80005-1, Utility connections in port – Part 1: High voltage shore connection (HVSC) systems – General requirements
- IEC/IEEE DIS 80005-3, Utility connections in port – Part 3: Low voltage shore connection (LVSC) systems – General requirements
- IEEE Std. 519-2014 - IEEE Recommended Practice and Requirements for Harmonic Control in Electric Power Systems

3.2 Transmission and distribution cable lines

The primary functions of transmission HV cables are to transfer electrical power between designated locations, within prescribed performance, operating and environmental conditions and to insulate energised components from earthed structures at rated operating voltages and specified switching and lightning impulses.

The present section presents relevant aspects related to SSE fixed power cables installations, including transmission line infrastructure equipment. HV electricity infrastructure, within the port area, will depend significantly on the port area layout, incoming transmission lines, SSE connection points, at different berth locations, amongst other factors.

Mobile SSE cable and cable handling system is covered in section 3.11.

Figure 3.21, indicates the sections within the SSE infrastructure scope where the fixed distribution HV system is relevant: Reception Interface, where the HV cables from utility grid will be received, either by overhead or underground cables; Port Grid distribution and Berth distribution.

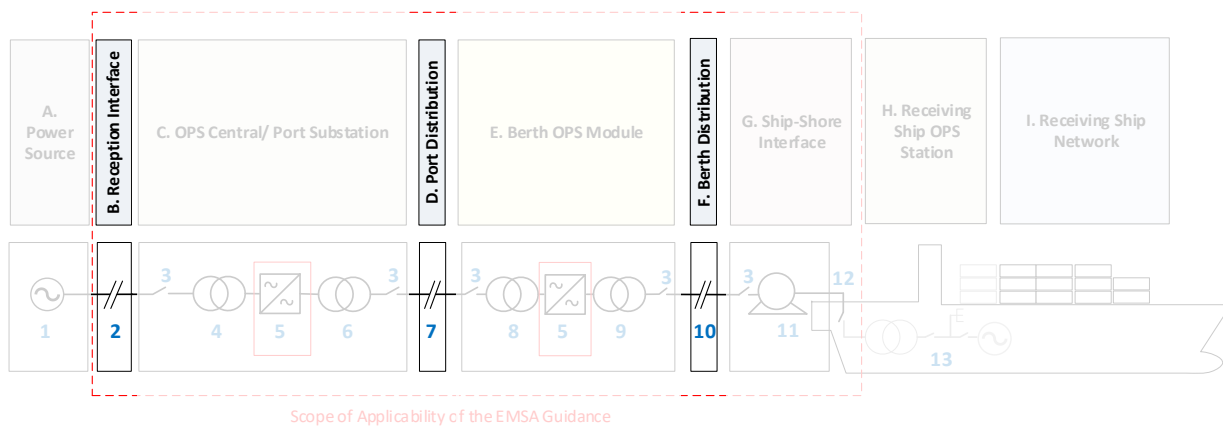

Figure 3.21 - Transmission and distribution cables.

Source: EMSA

The main aspects to be considered regarding distribution HV cabling, forming part of the SSE infrastructure, are:

- Identification of HV electrical distribution/transmission system (section 3.2.2)
- Conductor Sizing and Protection (section 3.2.2)
- Installation requirements for cable systems
- Determination of the smallest allowable cross-sectional area
- Short circuit current
- Protective Earthing conductor
- Neutral conductor
- Equipotential conductor

The present section highlights the key aspects that are related to the distribution cabling infrastructure, not covered by the IEC/IEEE 80005-1. Only general principles are presented and, where technical aspects are indicated, the relevant standard/reference document is indicated. General best practice principles are indicated with a view to the case of SSE installations.

3.2.1 Identification of HV electrical distribution/transmission system

The major components of an HV distribution cable system include:

- a. Cable (single or multi-core),
- b. Connections,
- c. Terminations at substations,
- d. Cable link boxes - Earthing and bonding system to manage safety and minimise losses, and
- e. Monitoring system components (for cable temperature monitoring and joint Partial Discharge (PD) measurements⁷).

a. Cable (single or multi-core):

Figure 3.22, presents the main layered components of an HV XLPE Insulated power cable, like those typically applied in underground distribution systems.

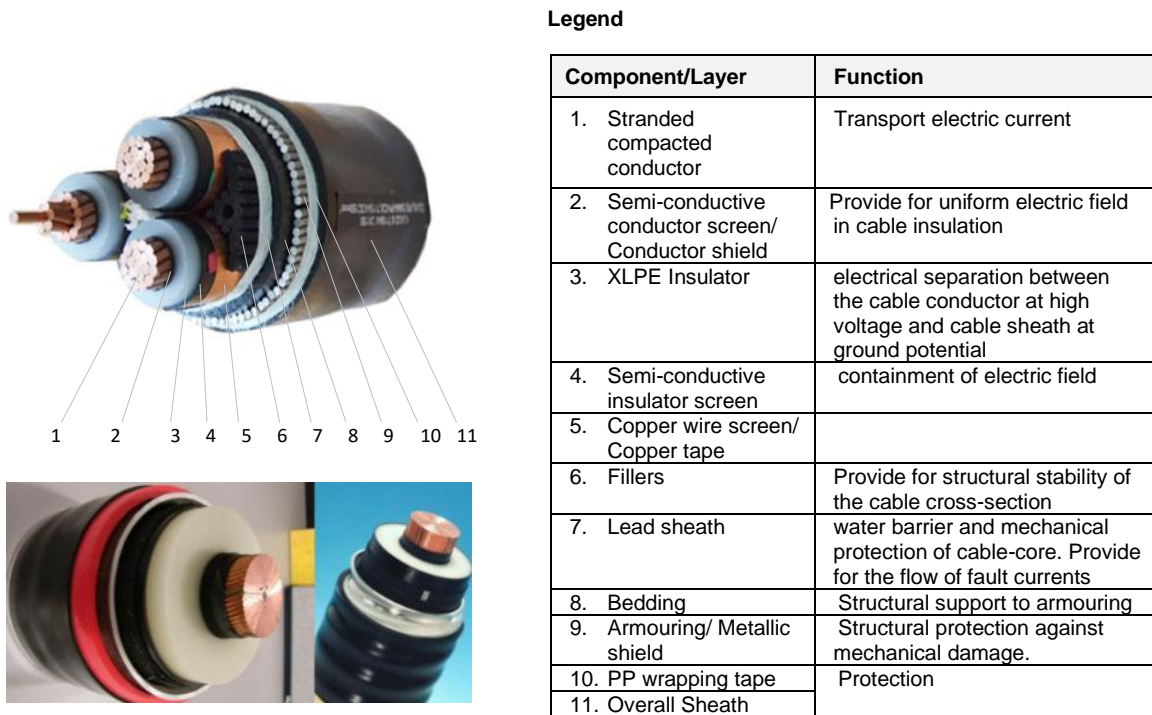

Figure 3.22 – HV insulated cable (multi-core and single core examples), including functions of the different layered components.

⁷ In power cables, PD occurs at insulation defects in particular in cable joints and terminations, especially at interfaces [1]. Therefore, PD measurement on cable systems can be considered a useful tool to diagnose insulation condition for both laboratory application and on-site application. PD in power cables is normally measured under AC voltage by using the conventional technique defined by IEC 60270.

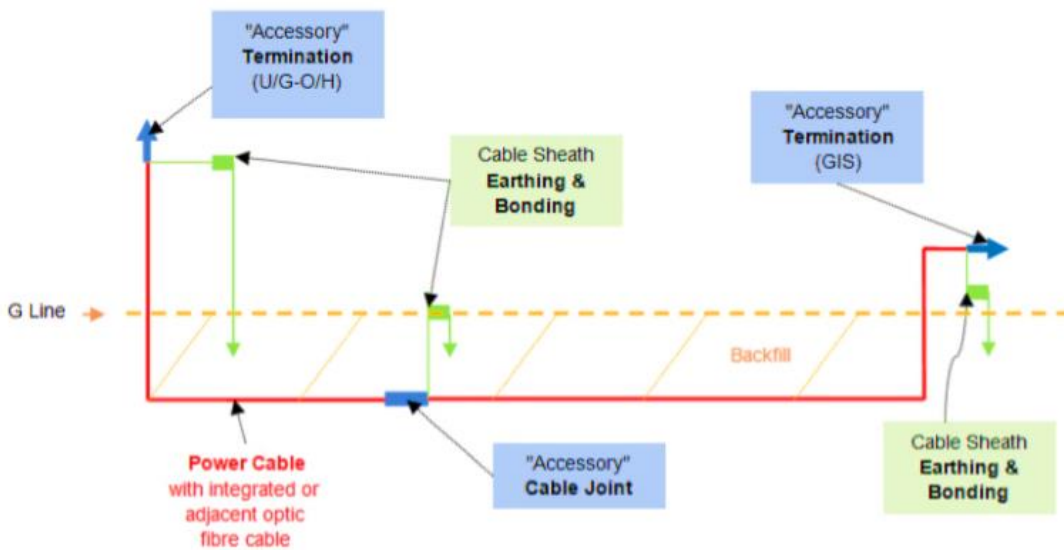

Figure 3.23 – Typical underground cable system.

HV cabling can be routed into and within the port area in different ways, depending on the local infrastructure aspects. Amongst the key aspects to consider are the mitigation of mechanical, fire and occupational hazards, ensuring a safe distribution of HV electrical AC/DC power throughout the different substations and SSE connection point in the port area.

Figure 3.24 to Figure 3.29, present different details of HV cable distribution infrastructure elements which may be considered for installation within the port area. The transmission/distribution via overhead poles would only be an option for inbound HV transmission in connection with utility grid, or for electrical power distribution between point separated by long distances (e.g., > 5 km) provided the routing line is kept clear of any conflicting overhead machinery mobile equipment and is clearly indicated as an intra-port power transmission line. The underground routing of HV cables within the port area should, however, be preferred.



Figure 3.24 – Overhead pole, 33 kV.

This may be a common solution for the HV utility supply for ports which are located at some distance from urban areas. Overhead transmission/distribution presents the advantage of less infrastructure cost and simplicity but can be incompatible with onsite area activity. Overhead HV cabling are typically uninsulated.



Figure 3.25 – Underground HV cable routed in a special concrete pit near-ground, prior to coverage.

The location of HV cables near surface presents a more expensive solution when compared to overhead transmission (due to cable insulation and protection). Near surface routing is also not preferred due to the potential for mechanical damage induced by heavy-duty activity within the port area.



Figure 3.26 – HV cable connections in underground cable vault.

Connections of HV cables follow a specific standard procedure that require skilled professionals and special fit-for-purpose equipment.



Figure 3.27 – HV cabling installation routed in tunnel.

This may represent an onerous option for ports with limited infrastructure. For larger areas this option provides a good option for improved maintainability and through-life-growth.

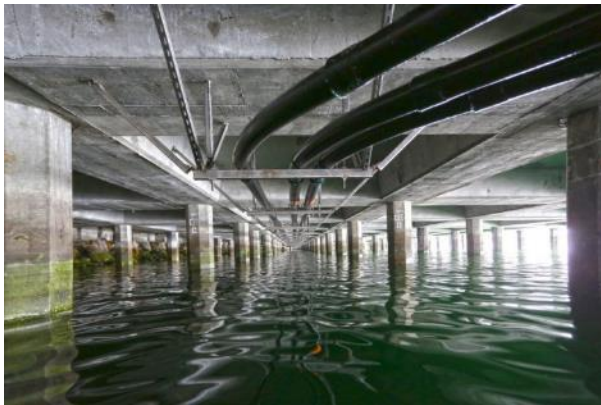

Figure 3.28 – Port of Long Beach – HV distribution underneath the pier.

The solution presented may have several advantages, following careful planning of work.



Figure 3.29 – Underground HV cable vaults can be subject to flooding.

b. Connections: The primary function of cable joints is to provide electrical and mechanical connections between power cable sections. These can be seen in Figure 3.26 and Figure 3.30.

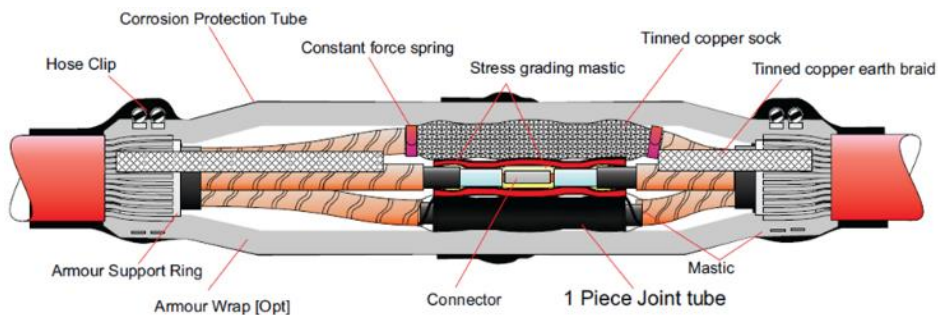

Figure 3.30 – Joint for XLPE Cable – diagrammatic representation.

Source: Nexans

c. Terminations: The primary function of cable terminations is to provide an electrical connection between power cables and other electrical plant, principally overhead lines, or substation infrastructure.

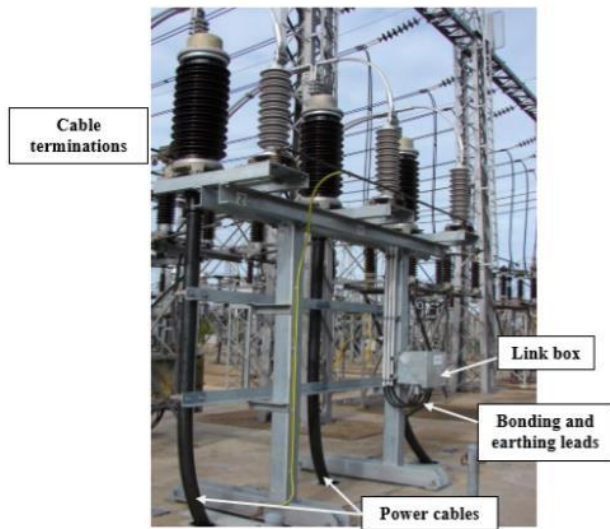

Figure 3.31 – Outdoor cable terminations.

Source: 3M

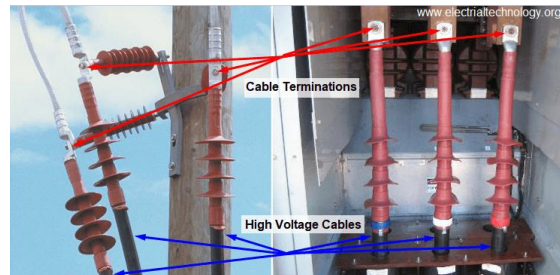
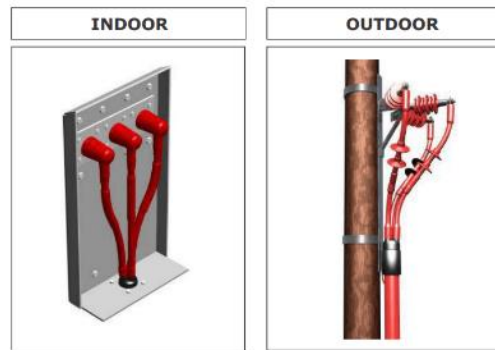

Figure 3.32 – Indoor and outdoor cable terminations.

Source: TRANSNET

d. Cable link boxes: The primary function of a cable link box is to provide a waterproof, accessible, and explosion proof enclosure for components forming part of a cable bonding and earthing system including surge arrestors, stand-off insulators and removable links for testing purposes. Bonding systems may include cross-bonding, single point bonding and mid-point bonding.

Figure 3.33 and Figure 3.34, present a typical arrangement of a cable link box. To be noted that the bonding allows equipotential sheaths of the 3 conductor cables, the conductor cores are fully isolated.

The cable link boxes are also used for monitoring.



Figure 3.33 – Typical Arrangement of Link-Box in Underground Concrete Pit.

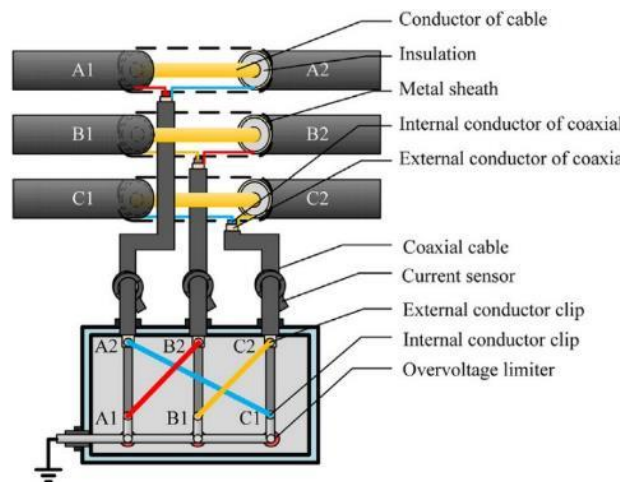

Figure 3.34 – Bonding scheme within a typical link box arrangement.

In Figure 3.35 a typical location of cable link boxes is indicated, adjacent to HV cable connections.

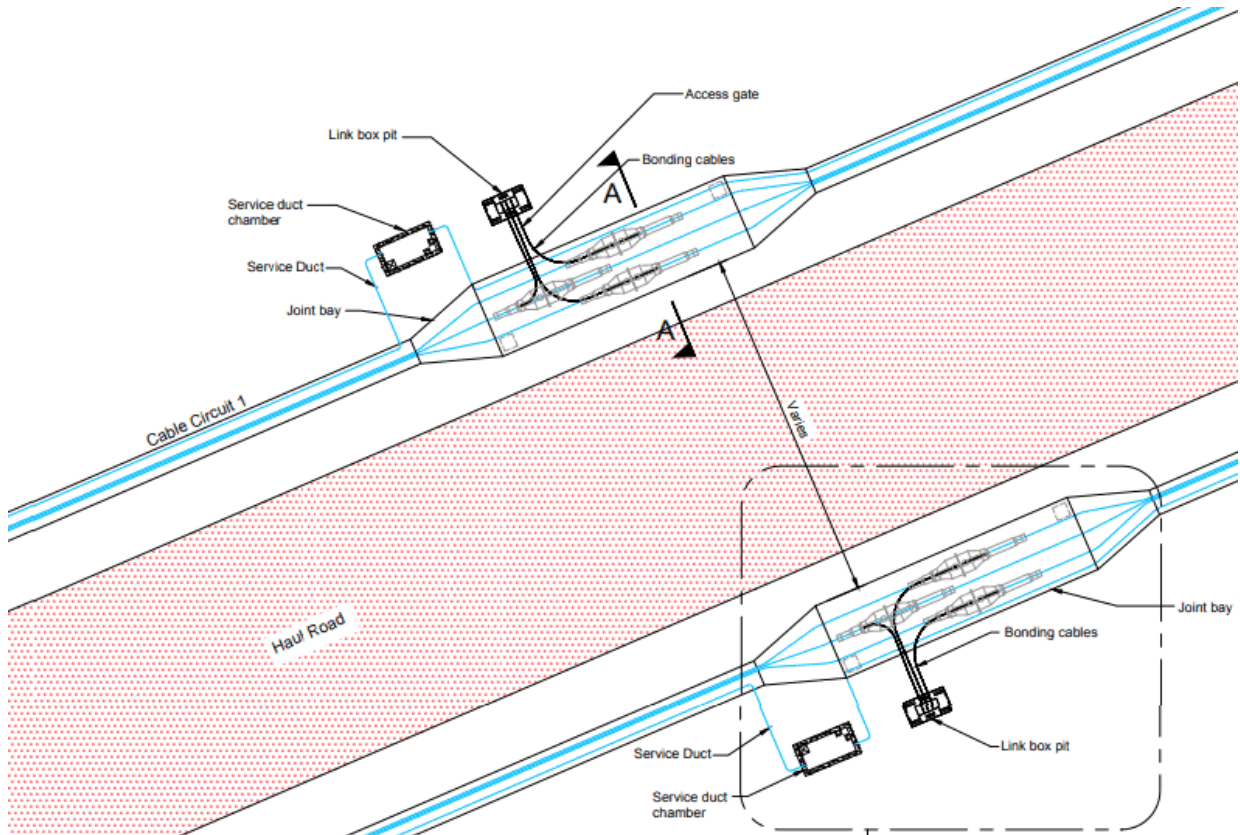

Figure 3.35 – Location for cable link boxes, at cable connections for equipotential bonding.

e. Monitoring system components:

Monitoring systems for HV cabling is essentially of 2 types: 1) temperature and 2) partial discharge monitoring. (Both monitoring approaches can be fixed or temporary):

- Temperature sensing is integrated by a Cable Monitoring Systems (CMS): The primary function of a cable CMS system is to monitor cable and ground temperature throughout a cable route utilising a distributed temperature sensing (DTS) system. Big-data analytics should allow the prevention of cable degradation.
- Partial Discharge (PD) monitoring, in cable systems, should be done in the locations illustrated in Figure 3.23. PD is a localized dielectric breakdown of a small portion of the electrical insulation. PD causes the insulation to deteriorate progressively and can lead to electrical breakdown. The integrity of the insulation of high-voltage equipment should be confirmed with PD measurement and analysis.

3.2.2 Conductor sizing and protection

Following a preliminary analysis of the power requirements of the whole SSE installation, considering the expected range and size of ships to be connected, individually and simultaneously at any given point in time, a study of cabling and its electrical protection is undertaken, starting at the origin of the installation/SSE Substation, through the intermediate stages to the final berth connection circuits.

The cabling and its protection at each level must satisfy several conditions at the same time to ensure a safe and reliable installation, including:

- Carrying the permanent full load current, and normal short-time overcurrent
- Not causing voltage drops likely to result in an inferior performance of certain connected loads,

Moreover, the protective devices (circuit-breakers or fuses) must:

- Protect the cabling and busbars for all levels of overcurrent, up to and including short-circuit currents (ref to IEC/IEEE 80005-1, Section 4.7 – rating for short-circuit current of 16kA RMS).
- Ensure protection of persons against indirect contact hazards (fault protection), particularly in TN- and IT- earthed systems, where the length of circuits may limit the magnitude of short-circuit currents, thereby delaying automatic disconnection.

The cross-sectional areas of conductors are determined by the general method described in 3.2.2 derived from application of IEC 60364-5-52:2009. Apart from this method some national standards may prescribe a minimum cross-sectional area to be observed for reasons of mechanical endurance or safety.

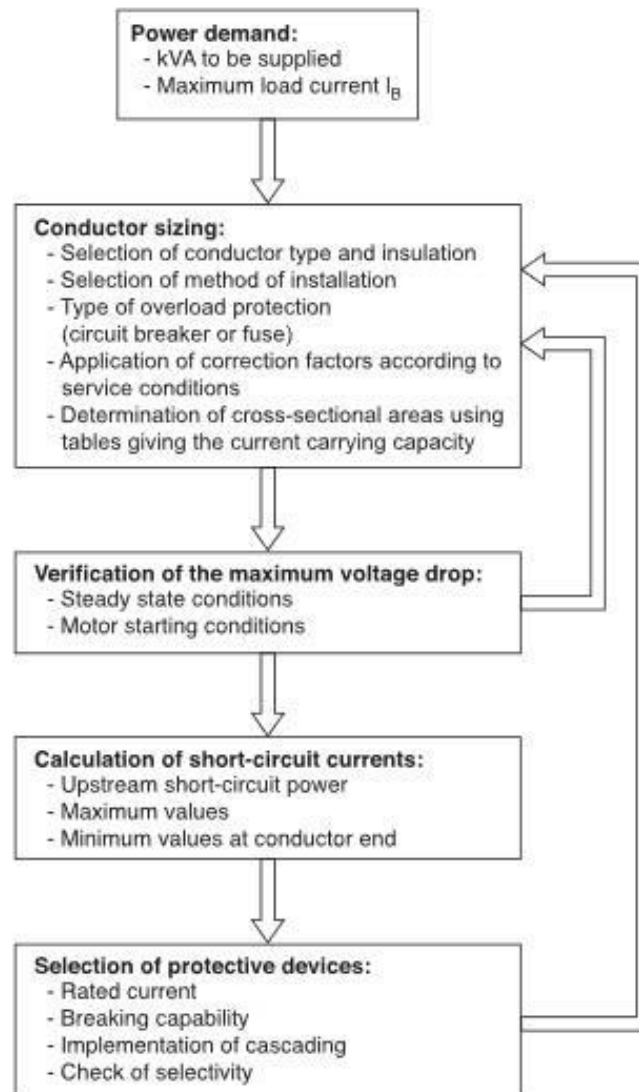

Figure 3.36 - Flow-chart for the selection of cable size and protective device rating for a given circuit.

Source: EMSA

Maximum load current: I_B

At the final circuits level, this design current (according to IEC ref 826-11-10) corresponds to the rated kVA of the load. In the case of motor-starting, or other loads which take a high in-rush current, particularly where frequent starting is concerned (e.g., lift motors, resistance-type spot welding, and so on) the cumulative thermal effects of the overcurrents must be considered. Both cables and thermal type relays are affected.

At all upstream circuit levels this current corresponds to the kVA to be supplied, which considers the diversity and utilization factors, k_s and k_u respectively, as shown in Figure 3.37.

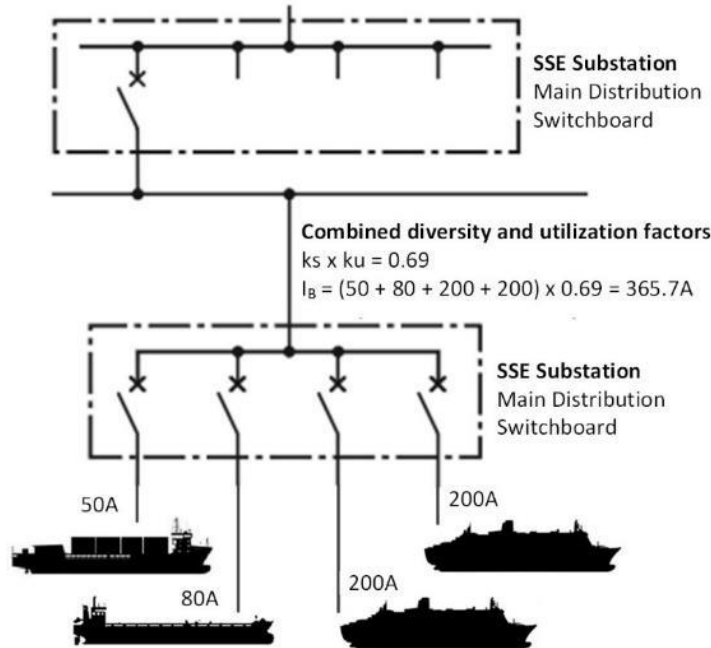

Figure 3.37 - Calculation of maximum load current I_B .

Source: EMSA based on [15]

Overcurrents

An overcurrent occurs each time the value of current exceeds the maximum load current I_B for the load concerned.

This current must be rapidly cut off with a response which depends upon the overcurrent event magnitude if permanent damage to the cabling (and appliance if the overcurrent is due to a defective load component) is to be avoided.

Overcurrents of relatively short duration can, however, occur in normal operation. Two types of overcurrent are distinguished:

- Overloads

These overcurrents can occur in healthy electric circuits, for example, due to a number of small, short-duration loads which occasionally occur co-incidentally: motor starting loads, and so on. If either of these conditions persists however beyond a given period (depending on protective-relay settings or fuse ratings) the circuit will be automatically cut off.

- Short-circuit currents

These currents result from the failure of insulation between live conductors or/and between live conductors and earth (on systems having low-impedance-earthed neutrals) in any combination:

- 3 phases short-circuited (and to neutral and/or earth, or not)
- 2 phases short-circuited (and to neutral and/or earth, or not)
- 1 phase short-circuited to neutral (and/or to earth)

Overload Protection

Overload protection is provided by a combination of different protective devices, including circuit breakers. A protective device is provided at the origin of the circuit concerned,

- Acting to cut-off the current in a time shorter than that given by the I^2t characteristic of the circuit cabling (see equation below)
- But allowing the maximum load current I_B to flow indefinitely

The characteristics of insulated conductors when carrying short-circuit currents can, for periods up to 5 seconds following short-circuit initiation, be determined approximately by the formula:

$$I^2t = k^2S^2$$

which shows that the allowable heat generated is proportional to the squared cross-sectional-area of the conductor.

Where:

t = Duration of short-circuit current (seconds)

S = Cross sectional area of insulated conductor (mm²)

I = Short-circuit current (A, RMS)

k = Insulated conductor constant

General reference to overload protection is included in section 3.3.

3.2.3 General best practice for HV cabling installations

The present section includes general best-practice requirements that should typically be considered when defining the procurement, commissioning, and installation of electrical distribution cable systems. National requirements, as issued by different national competent authorities, will have to be consulted prior to the definition of any project specifications. The best practice requirements are presented for 1) cable systems and 2) installation requirements.

General design requirements for cables

Design and selection of cable sizes and cable types must take into consideration the requirements mentioned below, and in accordance with the relevant standards for LV/HV cable systems (as indicated in Chapter B (Governance) and in the end of the present section:

- 1) cables must be suitable for all levels of demanding applications, considering electrical and mechanical factors on:
 - A. outdoor installation, above ground or underground (ducts, trenches or cable tunnels).
 - B. indoor installation in ducts.
 - C. locations exposed to direct sunlight (to be minimized and, in case inevitable, should be protected by adequate shadowing).
- 2) to meet the design requirements, electrical and mechanical design of the cable circuits should be undertaken.
- 3) Cables must be rated and installed to support the circuit maximum input and output powers, considering the maximum overloads that may occur, without any overheating and without any degradation to the service life as per manufacturer's indication.
- 4) Appropriate de-rating factors must be applied in the cable sizing calculations for factors that are different to the conditions nominated by the cable manufacturer in determining the standard cable current ratings. The de-rating factors must compensate for without limitation:

- A. the variations in the ambient temperature,
 - B. the variations in soil temperatures,
 - C. group heating effect,
 - D. depth of underground installation,
 - E. cable laying formation,
 - F. thermal resistivity of the soil, and
 - G. spacing.
- 5) Direct exposure of fixed insulated HV cables to sunlight should be avoided. If avoiding the cable direct exposure is not possible or impracticable, the insulation oversheath must be designed with adequate consideration to local-specific UV index, particularly for the cable sections which are directly exposed to sunlight.
- 6) The design of the cable systems must ensure that:
- A. The relevant reliability requirements are met for the specific project
 - B. adequate provision is made for future expansion as defined in the project specifications.
 - C. the design and design calculations must include, but not be limited to:
 - i) cable size and sheath size calculation,
 - ii) cable sheath, single or double point-bonding system,
 - iii) voltage rise under fault conditions for single point bonding,
 - iv) type of installation, (e.g., in ground direct buried/conduit/cable trenches/cable ducts; above ground; cable tunnel),
 - v) selection of cable route, and
 - vi) for HV cables specifically, thermal performance of the cable installation.
- 7) where cables enter or pass through the substation or at locations possibly subject to electromagnetic or electrostatic interference, they should be screened/shielded.

Installation general requirements for cable systems

Cable systems (HV or LV) should be installed following an adequate engineering plan, considering the port infrastructure plans, security and safety aspects, subject to approval of

1. SSE Facility Organization
2. PAA
3. National competent authorities

The cable systems must be installed with due consideration to the following generic requirements:

1. Their installation should be in accordance with manufacturer's recommendations, with particular relevance given to earthing, shielding and connection of the HV cables, either above or below ground.
2. Cables should be arranged and installed in cable ducts for interior routes or conduits elsewhere.
3. Outdoor cables should be laid in conduits unless otherwise specified in project specifications.
4. Cables should ideally not be direct buried unless specifically allowed in the project specifications.
5. The final installation should be able to withstand any transverse loading likely to occur at any point along the cable route, with due consideration for vehicular loads, terminal specific loads (including gravity loads/weight, vibration, or other associated transient peak loads, likely to be associated to different port activities).

6. All cables should be installed for easy access throughout the entire length for future replacement and repair. Cable link boxes and other HV cabling accessories should be freely accessible, especially when located in underground ducts.
7. Adequate above-ground identification of the cable route should be considered, throughout the entire route of the cabling systems.
8. All new cable support, ducts and conduits should be used to no more than 50 percent of their working capacity, allowing for future expansion or modification.
9. Cables damaged during installation should be replaced in their entirety. If the PAA inspector, or competent representative on his behalf, has reason to doubt the integrity of the cable system, right to reject the cable system even if there is no sign of it being damaged should be reserved. Details of the cable installation must be included in the design documentation submitted to the PAA for review and approval before commencement of works.
10. Where cables are to be routed below water basins, channels or other waterways, specific watertight ducts should be used for routing and protection. At the margins there should be visual indication of HV submarine cable on both sides.

3.2.4 Technical standards and references - transmission and distribution cable lines

Transmission and Distribution Cable lines - Reference Standards:

- A. IEC 60826 Design criteria of overhead transmission lines
- B. EN50341-1:2012 Overhead electrical lines exceeding AC 1 kV. General requirements
- C. IEC 60364-5-52:2009 Low-voltage electrical installations - Part 5-52: Selection and erection of electrical equipment - Wiring systems
- D. IEC TR 61200-52:2013 Electrical installation guide - Part 52: Selection and erection of electrical equipment - Wiring systems
- E. IEC 60502-2, Power cables with extruded insulation and their accessories for rated voltages from 1 kV ($U_m = 1,2$ kV) up to 30 kV ($U_m = 36$ kV) – Part 2: Cables for rated voltages from 6 kV ($U_m = 7,2$ kV) up to 30 kV ($U_m = 36$ kV)
- F. IEC 60840 Edition 4.0 2011-11 “Power cables with extruded insulation and their accessories for rated voltages above 30 kV ($U_m = 36$ kV) up to 150 kV ($U_m = 170$ kV) – Test methods and requirements”
- G. IEC 60183:2015 Guidance for the selection of high-voltage A.C. cable systems
- H. IEC 61386-1:2008 Conduit systems for cable management - Part 1: General requirements

3.3 Protection systems

Protection systems are essential elements of all electrical power systems, providing for protection of both equipment (supply and receiving), installed network and operator.

Protection should be provided for all SSE systems, based on a “Monitoring-Alarm-Trip” principle, supported by fundamental electrical power parameters (current, voltage, frequency, phase sequence, etc)

Since protection systems are safety related equipment used in controlling electrical risk, these are featured in Part 2 Section 9 of the present Guidance.

Detailed requirements for electrical protection systems are described in:

- IEC/IEEE 80005-1, sections 6.3, 6.5.4, 8.3.3, 8.5.4
- IEC/IEEE 80005-1, sections 6.3, 6.5.4, 8.3.3, 8.5.4

Interlocking can be considered also as a Protection System, together with Earthing and Fault Monitoring. Predictive Failure systems, not required as per existing standards, can also be considered as important protection systems which may be considered with increasing relevance for SSE systems in the future.

3.4 Substations

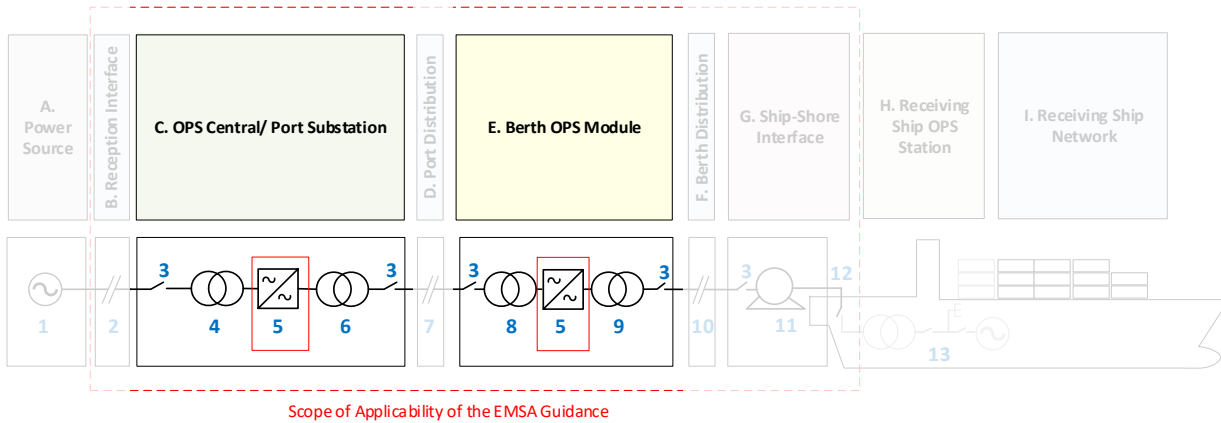

Figure 3.38 - Relevant key Substation possible locations – Central OPS substation and Berth OPS substation.

Source: EMSA

The present section presents some of the relevant elements that should be considered for SSE substations. Substations house the most important, safety critical and sensitive equipment in the SSE port grid. For this reason, the layout, location, and degree of protection are fundamental for the resilience of the SSE energy supply to ships at berth.



The number of substations is a direct function of the architectural choices and topologies for the SSE grid, including, but not limited to, the levels of voltage step-down transformation and/or frequency conversion equipment.



HV/LV substations may be built in any place within the port area, with preference for locations which allow for a compromise between protection and ease of access.

3.4.1 Types of Substation

According to the type of construction of the SSE substations these can be classified according to the table below.

Table 3.9 - Types of SSE substations.

<p>1. Indoor within a building, in a dedicated room</p>	<p>Substations located inside buildings, purpose-built or not, which may or may not incorporate other services within the port.</p> <p>It does not represent a preferred option due to the lack of flexibility, cooling requirements demanding for dedicated air conditioning and potential difficulties of access in normal or emergency operation.</p>	 <p>Source: CR Technology Systems S.p.A</p>
<p>2. Outdoor, fixed, inside a dedicated housing prefabricated or not</p>	<p>Outdoor HV/LV substations have been the preferred option in SSE installations, mainly due to the flexibility for installation in suitable locations within the port area.</p> <p>Also available in pre-fabricated units which allow for an easy "off-the-shelf" modular configuration. Pre-fabricated units are favoured by dry-transformers and SFCs.</p>	

<p>3. Outdoor, mobile, in modular containerised unit</p>	<p>In cases where a fixed substation installation is not the preferred option, and where flexibility is a priority, it is also possible to consider deployment and use of modular compact mobile substations. These may consist of truck-trailer units and be plugged in place to port grid and directly to ship at berth.</p>	
<p>4. Outdoor without housing</p>	<p>Outdoor substations, without housing, are common applications in industrial units but not so common for SSE installations. All equipment IP protection would have to be weatherproof.</p>	

3.4.1.1 Indoor substation

An indoor substation is one which is located within a dedicated infrastructure, especially designed, purpose-built or adapted, to house all the equipment necessary to transform and condition electrical energy from a supply point (e.g., utility grid) to a local/port/berth supply grid. Substations may be SSE dedicated or provide electricity to other port services. Control and monitoring in substation will increase with the level of integration of the substation with the entire port grid.

The following figures present examples of substation layouts, without and with frequency conversion.

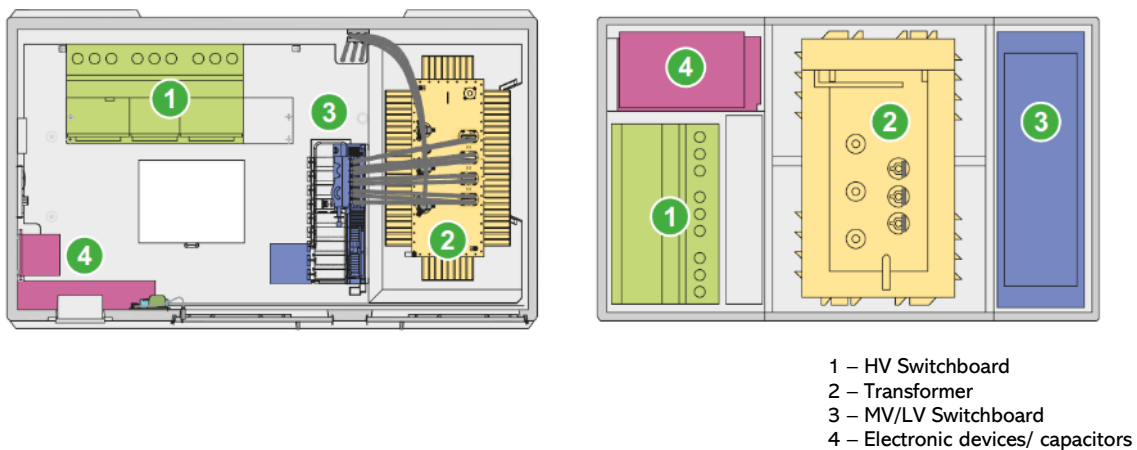

Figure 3.39 – Substation plant possible layout.

Source: Schneider Electric

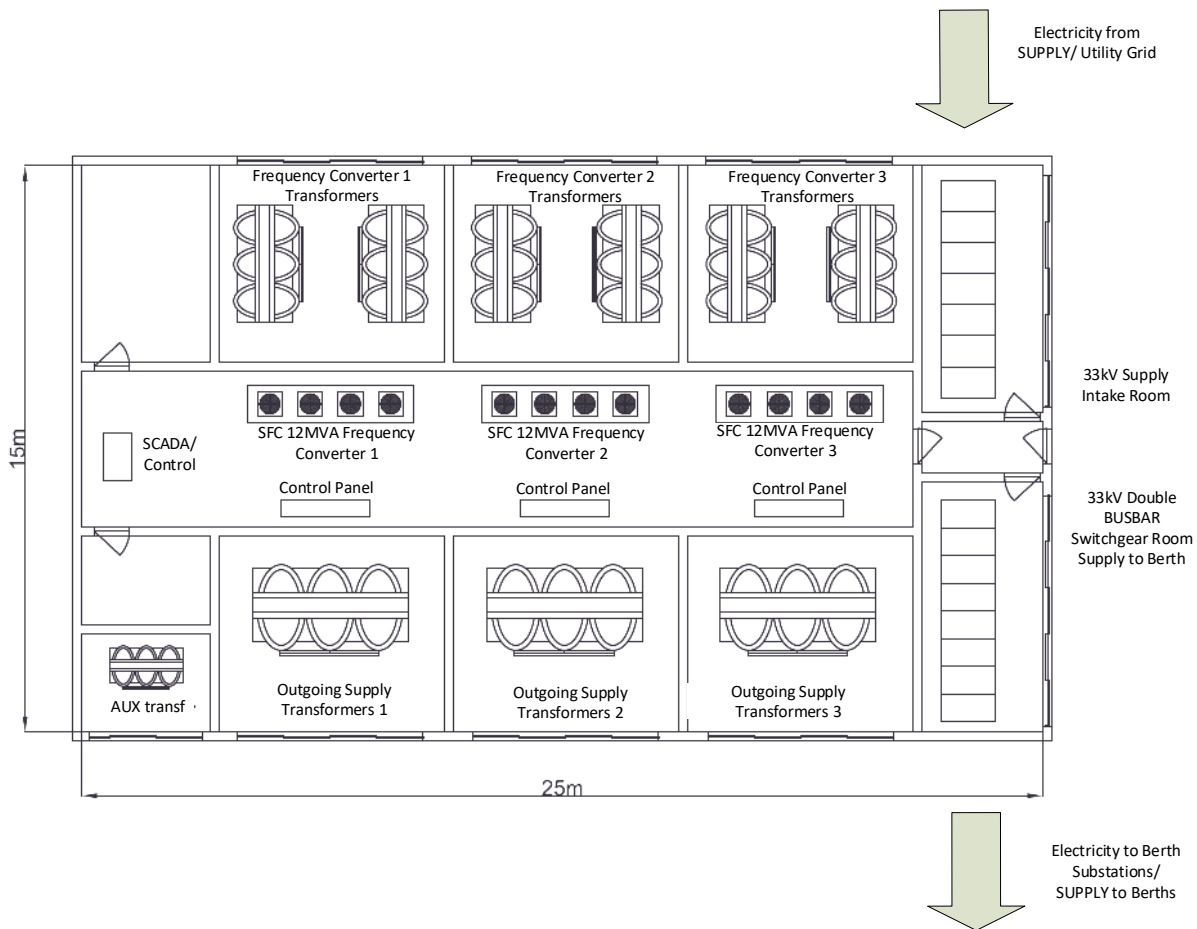

Figure 3.40 – Substation plant possible layout – with frequency conversion.

1. Connection to the utility and internal HV/MV and LV interconnections

Connection to the MV utility network is made by and should be under the responsibility of the utility or microgeneration electricity provider.

Connection between the HV/MV switchgear and the transformer may be realized by:

- Short copper/aluminium bars when the transformer is housed in a panel part of the MV switchboard
- Busway copper/aluminium bars, with epoxy resin insulated bars for applications above 1kV.
- By single-core or three cores screened cables with PR or EPR insulation, and possible connection to the transformers by plug-in type terminals.

Connection between the LV terminals of the transformer and the LV switchgear may be realized with:

- Single-core cables
- LV busway with heat-shrinkable insulation.

It is generally recommended to use busway for the connection of transformers requiring more than five single LV cables in parallel per phase. Above five single core cables per phase the equal share of the current in each cable cannot be ensured and the laying becomes a real difficulty. The following figures illustrate different types of connections.



Figure 3.41 – Substation above head busway.



Figure 3.42 – Dry-transformer - secondary winding connections - short bar connection to above head busway.

Source: Schneider Electric



Figure 3.43 – Dry-transformer - secondary winding connections by enclosed busway trunk.



Figure 3.44 – Dry-transformer - secondary winding connections by aluminium busway.



Figure 3.45 – Dry-transformer secondary connections by cable

To note the complex parallel arrangement of cables to cope with high current.

2. Earthing circuits

To ensure the safety of the persons an equipotential system must be created within the substation. It is realized according the following recommendations:

- Creation of an earthing electrode under the substation by burying copper conductors
- Inter-connection by means of protective conductors of all the exposed conductive parts of the installation:
 - Enclosures of the electrical equipment
 - Screens of the MV cables
 - Frame of the transformer
 - Metallic doors
 - Etc.
- Connection of all protective conductors at one single common point
- Connection of the common point of the protective conductors and the reinforcing rods of the concrete slab supporting the substation, should be connected to the earth electrode.

3. Lighting

The supply of the lighting circuits can be taken upstream or downstream from the main incoming LV circuit breaker. Appropriate LV circuit breakers must be provided for the protection of LV lighting circuits.

The lighting must adequately illuminate:

- The switchgear operating handles
- The mechanical flags indicating the position of electrical apparatus
- All the information displayed on the meters and on the protection relays
- All the instruction plates dedicated to the operations and the safety.

For safety reasons, it is recommended to add emergency lighting boxes including each an individual battery.

4. Materials for operation and safety

In accordance with a different number of local safety rules, the substation shall be equipped with the following safety equipment:

- Devices for the safe exploitation of the substation:
 - An Insulated stool
 - An insulated mat
 - A pair of insulated gloves stored in a dedicated box
 - A detector of MV voltage presence
- Fire-extinguishing devices complying with the local regulations
- Warning and instruction plates dedicated to:
 - Operation of the substation
 - Safety of the persons
 - First-aid care to victims of electrical accidents.

Detailed recommendations on Substation Fire Protection can be found in IEEE Std 979-2012 Guide for Substation Fire Protection, including Risk Assessment with substation hazard identification, Fire Suppression technical aspects and Fire Protection ratings for specific elements of the substation.

3.4.1.2 Outdoor substation

Outdoor substations can be modular/prefabricated or purpose-built, with or without housing. The present section highlights the substations of prefabricated type, given the high tendency in the market for the widespread application of such infrastructure products. Prefabricated SSE substations such as the ShoreBox® highlighted in the following images, provide easily configurable options for SSE project specific requirements which may vary significantly in terms of voltage, frequency conversion, protection, or automation.

The following figures and diagram show an example of a HVSC substation, located at a cruise terminal for supply of 6.6 kV 60 Hz to cruise ships at berth. The compact unit, of containerized casing architecture, is located here in direct supply to one berth position. The high-power demand of certain ship types, like cruise ships, and the need for flexibility and margin for growth are some of the key aspects that favour prefabricated modular “off-the-shelf” substation units.

Replaceability of standard components from inside the substation (transformers, SFC modules, capacitor banks or even circuit breakers, is another key aspect favouring prefabricated, pre-tested and standardised units.

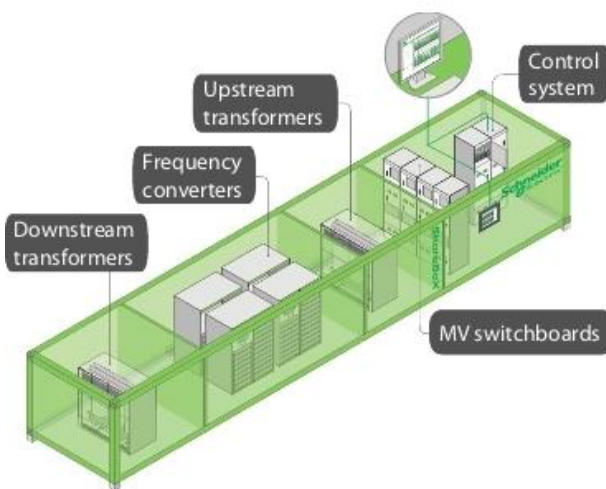

Figure 3.46 – Prefabricated OPS substation.

Source: Schneider

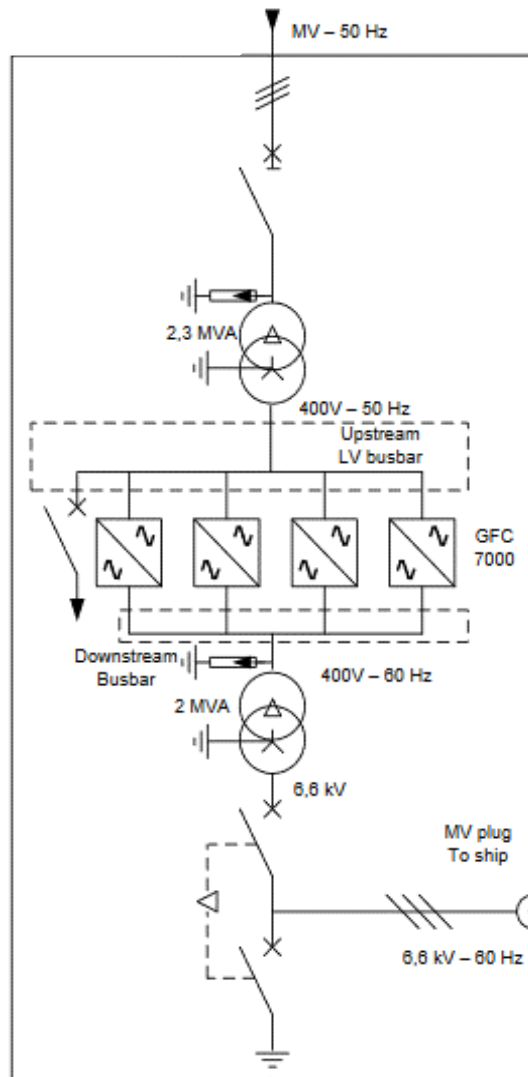

Figure 3.47 – Prefabricated OPS substation – single line diagram.

Source: ABB

Prefabricated outdoor MV/LV substations should comply with IEC 62271-202 standard (*IEC 62271-202:2014 High-voltage switchgear and controlgear - Part 202: High-voltage/low-voltage prefabricated substation*)

IEC 62271-202:2014 specifies the service conditions, rated characteristics, general structural requirements and test methods of high voltage/low voltage or low voltage/high voltage prefabricated substations, which are cable-connected, to be operated from inside (walk-in type) or outside (non-walk-in type) for alternating current of rated voltages above 1 kV and up to and including 52 kV on the high voltage side, and for one or more transformers for service frequencies up to and including 60 Hz for outdoor installation at locations with public accessibility and where protection of personnel is provided.

In accordance with IEC 62271-202 a type tested prefabricated outdoor substation is subjected to tests and verifications dedicated to:

- Degree of protection
- Temperature class
- Non-flammable materials
- Mechanical resistance of the enclosure

- Sound level
- Insulation level
- Internal arc withstand
- Earthing circuit
- Retention of oil
- Operation of the substation.

3.4.2 Ventilation in MV Substations

Substation ventilation is generally required to dissipate the heat produced by transformers and other equipment, and to allow drying after particularly wet or humid periods.

However, several studies have shown that excessive opening can drastically increase condensation.

The following paragraphs highlight recommendations and good practices to ensure proper ventilation of MV substations.

Remark concerning HV/LV outdoor prefabricated substation in special service conditions

- Any installation of a transformer in the same room or in the same enclosure as HV and LV switchgears will impact the lifespan of the products.
- Any air flow generated by the transformer heating reduces the impact of irradiance. This air flow is the natural convection as required by the IEC 62271-202 standard.
- Any separation of the transformer by a partition wall with the HV and LV switchgears compartment improves the service condition of the switchgears for moderate climates, and avoids exposing them to harsh environment, especially relevant in maritime port areas.
- For outdoor installations, any switchgear should be preferably installed in a thermal insulated enclosure protecting it from outdoor service conditions (dust, humidity, solar radiation etc.) especially for very hot and cold climates, and harsh environment.

Recommendations for HV/LV substation ventilation

Ventilation is an important aspect to consider when designing and selecting configuration for SSE prefabricated substations. Being compact units, the decision-making process should include, from a very early stage in the design, due consideration for natural, forced, or air-conditioned ventilation. Table 3.10 includes recommendation for ventilation of HV/MV/LV substations.

Table 3.10 – Recommendations for ventilation of HV/MV/LV OPS substations.

<p><u>General</u></p>	<p>Ventilation should be kept to the minimum level required.</p> <p>Furthermore, ventilation should never generate sudden temperature variations that can cause the dew point to be reached. For this reason, natural ventilation should be used whenever possible. Heating could be required when the application can be de-energized for a period; this is to maintain a minimum air flow. If forced ventilation is necessary, the fans should operate continuously to avoid temperature fluctuations. When forced ventilation is not enough to assure the indoor service condition of the switchgear or when the installation surrounding is a hazardous area, HVAC unit will be necessary to separate completely the indoor service conditions to the outdoor service conditions.</p> <p>Natural ventilation is the mostly used method for MV installations (see figures below).</p>
------------------------------	--

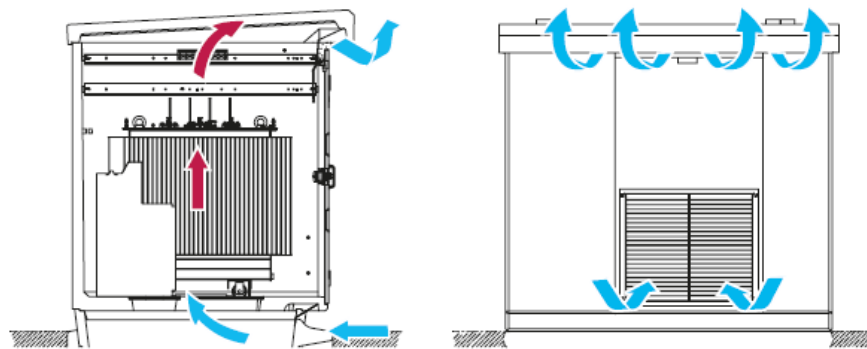

Figure 3.48 – Prefabricated OPS substation – natural ventilation [15].

Ventilation opening locations

To favour evacuation of the heat produced by the transformer via natural convection, ventilation openings should be located at the top and bottom of the wall near the transformer. The heat dissipated by the MV switchboard could be neglected.

To avoid condensation problems, the substation ventilation openings should be located as far as possible from the switchboards (figure below).

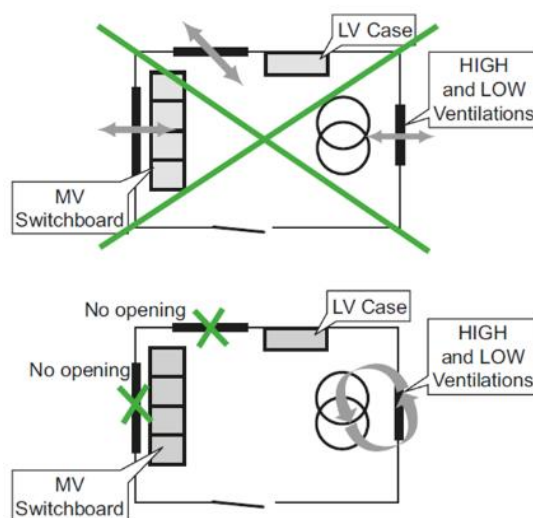

Figure 3.49 – Ventilation of prefabricated substations – location of openings [15].

Type of ventilation openings

To reduce the entry of dust, pollution, mist, etc., the substation ventilation openings should be equipped with chevron-blade baffles when the transformer is installed in a same room with the switchboards, otherwise the use of higher efficiency ventilation grids is allowed, especially advised when total losses are above 15 kW.

Temperature variations inside cubicles

To reduce temperature variations, always install anti-condensation heaters inside MV cubicles if the average relative humidity can remain high over a long period of time. The heaters must operate continuously, 24 hours a day, all year long. Never connect them to a temperature control or regulation system as this could lead to temperature variations and condensation as well as a shorter service life for the heating elements. Make sure the heaters offer an adequate service life.

Temperature variations inside the substation

The following measures can be taken to reduce temperature variations inside the substation:

- Improve the thermal insulation of the substation to reduce the effects of outdoor temperature variations on the temperature inside the substation
- Avoid substation heating if possible. If heating is required, make sure the regulation system and/or thermostat are sufficiently accurate and designed to avoid excessive temperature swings (e.g., no greater than 1°C). If a sufficiently accurate temperature

	<p>regulation system is not available, leave the heating on continuously, 24 hours a day, all year long</p> <ul style="list-style-type: none"> • Eliminate cold air drafts from cable trenches under cubicles or from openings in the substation (under doors, roof joints, etc.).
<u>Substation environment and humidity</u>	<p>Various factors outside the substation can affect the humidity inside.</p> <ul style="list-style-type: none"> • Plants: avoid excessive plant growth around the substation and closing any opening. • Substation waterproofing: the substation roof must not leak. Avoid flat roofs for which waterproofing is difficult to implement and maintain. • Humidity from cable trenches: make sure cable trenches are dry under all conditions. A partial solution is to add sand to the bottom of the cable trench.
<u>Pollution protection and cleaning</u>	<p>Excessive pollution favours leakage current, tracking and flashover on insulators.</p> <p>To prevent MV equipment degradation by pollution, it is possible to either protect the equipment against pollution or regularly clean the resulting contamination.</p>
<u>Protection</u>	<p>Indoor MV switchgear can be protected by enclosures providing a sufficiently high degree of protection (IP).</p>
<u>Cleaning</u>	<p>If not fully protected, MV equipment must be cleaned regularly to prevent degradation by contamination from pollution.</p> <p>Cleaning is a critical process. The use of unsuitable products can irreversibly damage the equipment.</p>

3.5 Switchboards

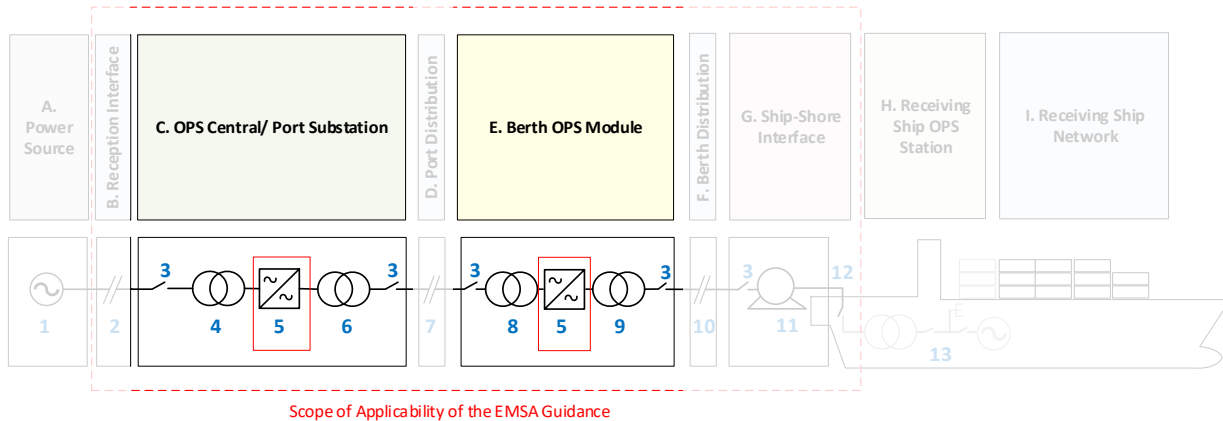

Figure 3.50 - Relevant key switchboard locations – central OPS substation and berth OPS module.

Source: EMSA

Reference Standards:

- A. IEC 62271-200:2020 Series - High-voltage switchgear and controlgear
- B. IEC 61439 Series - Low-voltage switchgear and controlgear assemblies
- C. UL891 - Deadfront Distribution Switchboards
- D. NEMA Standard PB2 - Deadfront Distribution Switchboards

Switchboards are important components for the SSE system. They are typically metal sheet covered units containing different components which are inserted in modular units. Examples of Switchboard units are presented in Figure 3.51 and Figure 3.52.



Figure 3.51 – Typical switchboard front panel view.

Front panel organization includes the main user interface elements, metering, switches, and command/controls.

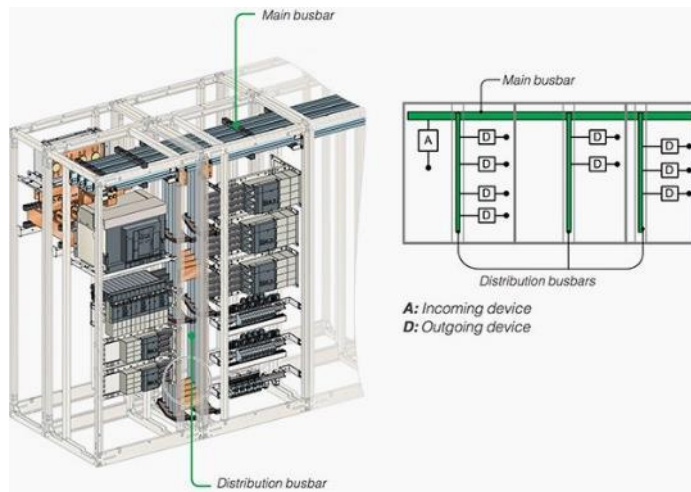

Figure 3.52 – Switchboard/internal view/representation of main and distribution busbars, incoming and outgoing devices.

The main internal elements of the switchboards are the busbars, typically low impedance copper flat bars.

An electric switchboard is an element that directs electricity from one or more sources of supply to several consumers or other switchboards. It is an assembly of one or more panels, containing switches that allow electricity to be redirected. A switchboard is divided into different interconnected sections, generally consisting of a main section and a distribution section.

Inside a switchboard there will be one or more busbars (Figure 3.52). These are flat strips of copper or aluminium, to which the switchgear is connected. Busbars carry large currents through the switchboard and are supported by insulators. Bare busbars are common, but many types are now manufactured with an insulating cover on the bars, leaving only connection points exposed.

The operator is protected from electrocution by safety switches and fuses. There may also be controls for the supply of electricity to the switchboard, plus gauges showing frequency, current intensity, amongst other relevant instruments. The amount of power going into a switchboard must always be substantially equal to the power going out to the loads (less the losses in internal conductors and consumption by internal devices such as pilot lamps, space heaters, or others).

Switchboards incorporate typically the following elements:

- E. Incoming cables, which may be either high voltage (HV) or low voltage (LV). For high voltage, they will normally be either impregnated paper insulation (unlikely these days), cross linked polyethylene (XLPE) or ethylene propylene rubber (EPR) insulated cable. The last two types are the preferred types for new installations, with XLPE being the most common. For low voltages the cables may be XLPE or elastomer (EPR) type cables.
- F. Outgoing circuit conductors, consisting of insulated cables, insulated busbars, busbar trunking systems, mineral insulated metal-sheathed (MIMS) cables or fire-resistant cables.
- G. Internal busbars, which may be rigid copper (or aluminium) bars (insulated or uninsulated) in larger SWBs or simply insulated single phase cables in small SWBs. In large capacity SWBs each phase may have several conductor sections.
- H. Main isolating switch or section switches, allowing segregation of the switchboard or its component parts to allow maintenance work.
- I. Circuit breakers, HV/LV, depending on the switchboard voltage level.
- J. Fuses, to protect apparatus and equipment against the thermal and dynamic effects of short-circuits. The outstanding features of MV fuse-links are:
- K. MV fuses HRC (High Rupturing Capacity) and CFS (Combined Fuse-Switch)
- L. Protection relays - used for the higher voltages, together with their associated instrument transformers (current transformers (CTs) and voltage transformers (VTs)). Overcurrent protection units are used to activate timing relays to provide proper fault protection operation. At lower voltages, the circuit breakers will normally have in-built fault detection sensing and thus no separate relaying is required
- M. Metering equipment/instruments
- N. Over-voltage and current surge protection
- O. Earth fault monitoring
- P. Fault detection equipment and instruments
- Q. Earth switch

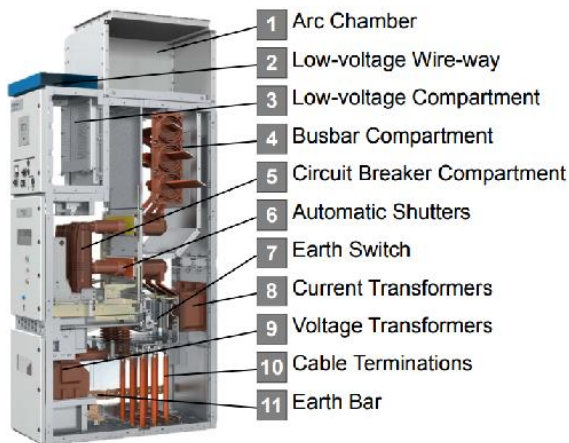

Figure 3.53 – Typical switchboard complete unit module – indication of main general elements.

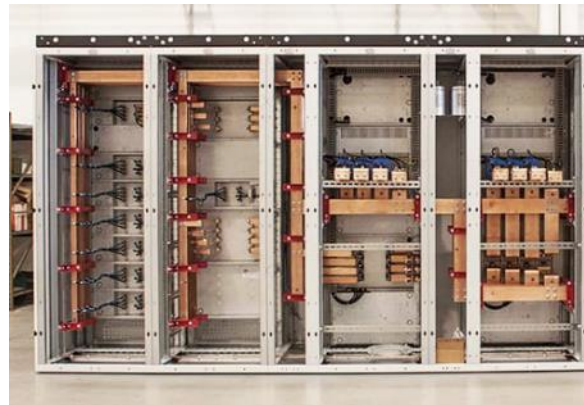

Figure 3.54 – Switchboard/rear view showing bus bars.



Figure 3.55 – Verification conducted on a circuit-breaker.

Switchboards' front panels can be opened during testing or maintenance activities. These are tasks to be performed by specialised personnel.



Figure 3.56 – Switchboard operation is done either remotely or locally in the front panels.

Operation should be guided by clear instructions and labelled instruments.

3.5.1 Switchboards in SSE

The number of switchboards in SSE infrastructure applications will depend on the architecture of the whole system, in particular the number of interfaces, substations, frequency converters, transformers, energy storage elements, amongst other relevant factors. A minimum number of Switchboards can be considered when looking at both standards IEC/IEEE 80005-1 and 3, as presented below. Elements/equipment/protections are included as per minimum requirements of both HVSC and LVSC standards.

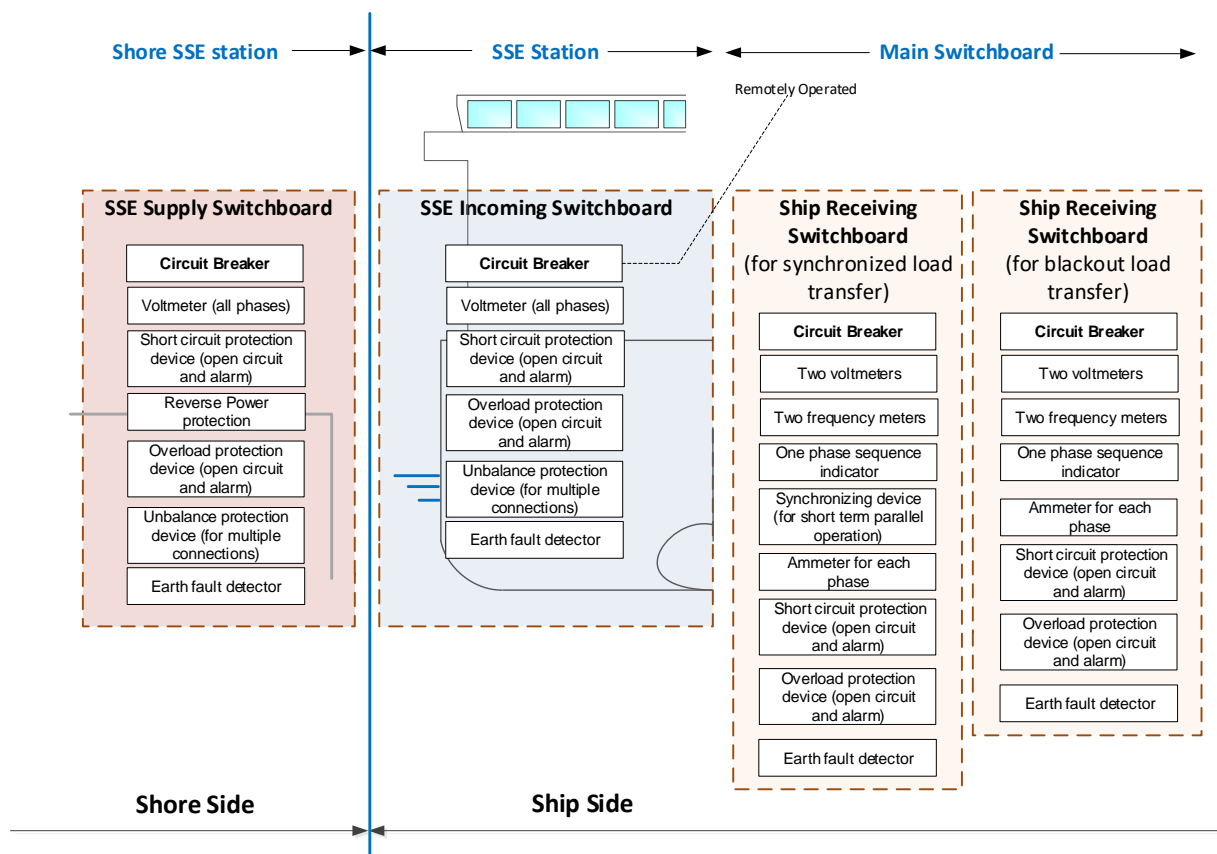

Figure 3.57 – Minimum number of switchboards and its elements in SSE systems.

Source: EMSA

3.5.1.1 SSE Supply Switchboard

The SSE Supply Switchboard should be located at a convenient location, taking into consideration the port/terminal SSE infrastructure design. Depending on the general arrangement for the shore side, it is possible to consider 3 (three) different locations for the installation of relevant switchboards:

1. Incoming station, receiving power from the grid, including possible transformer(s) and power quality/metering equipment.
2. Central substation, where power from incoming station is received (directly or transformed). Frequency Conversion is usually at this location, representing a significant footprint for the substation design.
3. Berth station, where the SSE supply switchboard should be located, including all relevant protections, control, and monitoring/instruments. Several supply points/berth junction boxes (JB) can be fed by one single berth station switchboard.

The HV circuit breaker on the secondary side of the transformer shall open all insulated poles in the event of the following conditions:

- a. overcurrent including short-circuit;
- b. over-voltage/under-voltage;
- c. reverse power;
- d. earth fault; or
- e. unbalanced cable protection.

To satisfy this requirement, at least the following protective devices, or equivalent protective measures, shall be provided:

- a. synchro check or voltage sensing device (for dead bus verification),
- b. undervoltage,
- c. reverse power,

- d. negative phase sequence overcurrent,
- e. instantaneous overcurrent,
- f. AC inverse time overcurrent,
- g. earth fault overcurrent,
- h. overvoltage; and
- i. AC directional overcurrent.

The protection systems shall be provided with battery back-up adequate for at least 30 min.

Upon failure of the battery charging or activation of the back-up system, an alarm shall be communicated to the ship.

3.5.1.2 SSE Incoming Switchboard

The HV shore connection switchboard is to be designed, manufactured, and tested in accordance with a recognized standard such as IEC 62271-200.

The circuit breakers in the shore connection switchboard are to be as follows:

- a. HV circuit breaker is to be equipped with low voltage protection (LVP)
- b. The rated short-circuit making capacity of the circuit breaker is to be greater than the prospective peak value of the short-circuit current
- c. The rated short-circuit breaking capacity of the circuit breaker is to be greater than the maximum prospective short-circuit current (rms value).
- d. HV shore connection circuit breaker is to be remotely operated

Backup power supply for operation of at least 30 minutes is to be provided for the instrumentation devices. In the event of a breakdown of this backup power supply, alarm is to be given in the machinery control room. The following instrumentation is to be provided in the shore connection switchboard:

- a. Voltmeter (all phases)
- b. Short circuit protection device (open circuit and alarm)
- c. Overload protection device (open circuit and alarm)
- d. Earth fault detector
- e. Unbalance protection device (for multiple connections)

The shore connection switchboard is to be located onboard the vessel in a dry space close to the connection point, for the reception and extension of the ship to the shore connection cable.

3.5.1.3 Ship Receiving Switchboard

The ship receiving switchboard is to be designed, manufactured, and tested in accordance with a recognized standard such as IEC 62271-200.

The circuit breakers in the ship receiving switchboard are to be as follows:

- The rated short-circuit making capacity of the circuit breaker is to be greater than the prospective peak value of the short-circuit current
- The rated short-circuit breaking capacity of the circuit breaker is to be greater than the maximum prospective short-circuit current (rms value).
- HV connection circuit breaker is to be remotely operated

The following instrumentation is to be provided in the ship receiving switchboard:

A. If load transfer by synchronization

- a. Two voltmeters
- b. Two frequency meters
- c. One phase sequence indicator
- d. Synchronizing device (if designed for short term parallel operation)
- e. Ammeter for each phase
- f. Short circuit protection device (open circuit and alarm)
- g. Overload protection device (open circuit and alarm)
- h. Earth fault detector

One voltmeter and one frequency meter are to be connected to the switchboard bus bars; the other voltmeter and frequency meter are to enable the voltage and frequency of the shore connection to be measured.

B. If load transfer by blackout

- i. One Voltmeter
- j. Phase sequence indicator
- k. One Frequency meter
- l. Ammeter for each phase
- m. Short circuit protection device (open circuit and alarm)
- n. Overload protection device (open circuit and alarm)
- o. Earth fault detector

3.6 Circuit breakers

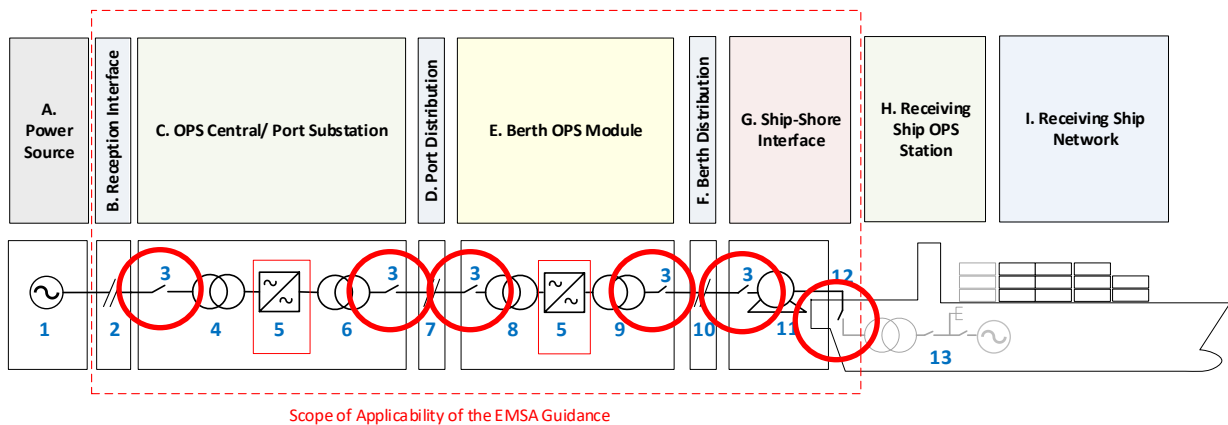

Figure 3.58 - Relevant key Circuit Breaker locations – Red circles point to the generic locations where relevant Circuit Breakers can be found.

Source: EMSA

3.6.1 Standards

The HV and LV standards for circuit breakers applicable to SSE systems are different. The following table presents the relevant standards depending on the shore connection type/installation:

Table 3.11 – Relevant standard for circuit breakers applicable to SSE depending on shore connection type.

Shore Connection		Standard	Reference in Shore Connection standards
HVSC	 <p>Source: ABB</p>	IEC 62271-200:2011 High-voltage switchgear and controlgear - Part 200: AC metal-enclosed switchgear and controlgear for rated voltages above 1 kV and up to and including 52 kV	Section 6.2.1, 6.3, 6.4.2 Section 8.3.1, 8.3.2 Section 10.2.2, 10.3.2, 10.4.2
LVSC		IEC 60947-2:2016+AMD1:2019 CSV Low-voltage switchgear and controlgear - Part 2: Circuit-breakers	Section 4.9 Section 6.2.1 Section 8.3.2, 8.5.2

The main difference between the high voltage and low voltage circuit breakers is on the level of protection against arcing. HV circuit breakers have vacuum or Sulphur hexafluoride (SF6) arc quenching enclosures. Other differences can be identified, but the most remarkable is related to the voltage rating and distinction between HV and LV.

There are, in fact, many circuit breaker types, with integration of electromechanical/thermal control/tripping units, commanded by dedicated relays, and, already in a large number of LV/HV circuit breakers, microprocessor units which allow for an optimized control over the tripping response of the same circuit breaker, depending on circuit and end-user requirements.

3.6.2 Functions

Circuit breakers are part of a variety of different switchgear items which can be used for the purpose of controlling an electrical installation. The selection of the adequate switchgear is made in accordance with the required protection function and desired exploitation of any given circuit, under normal, contingency or emergency situations.

The following table compares the different type of control and protection functions for different switchgear available, highlighting the relevance of circuit breakers in comparison with other switchgear.

Table 3.12 – Functions fulfilled by different items of switchgear [15].

Switchgear item	Isolation	Control				Electrical Protection		
		Functional	Emergency Switching	Emergency Stop (mechanical)	Switching for mechanical maintenance	Overload	Short-circuit	Electric shock
Isolator or disconnecter [d]								
Switch [e]			[a]	[a], [b]				
Residual Device (RCCB) [e]			[a]	[a], [b]				
Switch-disconnector			[a]	[a], [b]				
Contactors			[a]	[a], [b]		[c]		
Remote Control Switch			[a]	[a], [b]				
Fuse			[a]	[a], [b]				
Circuit Breaker			[a]	[a], [b]				
Circuit Breaker-Disconnectors [e]			[a]	[a], [b]				
Residual and Overcurrent circuit breaker (RCBO) [e]			[a]	[a], [b]				
Point of installation (general principle)	Origin of each circuit	All points where, for operational reasons it may be necessary to stop the process	In general, at the incoming circuit to every distribution board	At the supply point to each machine and/or on the machine concerned	At the supply point to each machine	Origin of each circuit	Origin of each circuit	Origin of circuits where the earthing system is appropriate TN-S, IT, TT
Notes [a]. Where cut-off of all active conductors is provided [b]. It may be necessary to maintain supply to a braking system [c]. If it is associated with a thermal relay [d]. In certain countries a disconnecter with visible contacts is mandatory at the origin of a LV installation supplied directly from a MV/LV transformer [e]. Certain items of switchgear are suitable for isolation duties (e.g., RCCBs according to IEC 61008) without being explicitly marked as such [f]. Circuit breaker and fuse can ensure also protective measure in case of fault by automatic disconnection of the supply								

As shown in the table above, the circuit breaker/disconnector is the only item of switchgear capable of simultaneously satisfying all the basic functions necessary in an electrical installation.

Moreover, it can, by means of auxiliary units, provide a wide range of other functions, for example: indication (on-off - tripped on fault); undervoltage tripping; remote control etc. These features make a circuit breaker/ disconnecter the basic unit of switchgear for any electrical installation, which is also and particularly the case for SSE electrical installation.

More specifically, on the circuit breaker/disconnector the following functions are selected:

Table 3.13 – Circuit Breaker functions [15].

Functions		Possible conditions
Isolation		
Control	Functional	
	Emergency Switching	With the possibility of a tripping coil for remote control
	Switching-off for mechanical maintenance	
Protection	Overload	
	Short-circuit	
	Insulation fault	With differential-current relay
	Undervoltage	With undervoltage-trip coil
Remote Control		Added or incorporated
Indication and measurement		Generally optional with an electronic tripping device

3.6.3 Fundamental characteristics

The fundamental characteristics of a circuit breaker are:

- **Rated voltage U_e** - voltage at which the circuit breaker has been designed to operate, in normal (undisturbed) conditions.
Other values of voltage are also assigned to the circuit breaker, corresponding to disturbed conditions.
- **Rated current I_n** - maximum value of current that a circuit breaker, fitted with a specified overcurrent tripping relay, can carry indefinitely at an ambient temperature stated by the manufacturer, without exceeding the specified temperature limits of the current carrying parts.
- **Frame-size rating** - A circuit breaker which can be fitted with overcurrent tripping units of different current level-setting ranges, is assigned a rating which corresponds to the highest current-level-setting tripping unit that can be fitted.
- **Overload relay trip-current setting (I_r or I_{rth})** – LV/MV industrial circuit breakers are equipped with exchangeable overcurrent-trip relays. In addition, in order to adapt a circuit breaker to the requirements of the circuit it controls, and to avoid the need to install over-sized cables, the trip relays are generally adjustable. The trip-current setting I_r or I_{rth} (both designations can be found) is the current above which the circuit breaker will trip. That value must be greater than the maximum load current I_B , but less than the maximum current permitted in the circuit I_Z . Thermal-trip relays are generally adjustable from 0.7 to 1.0 times. If electronic devices are used, the adjustment range is greater; typically, 0.4 to 1 times I_n .

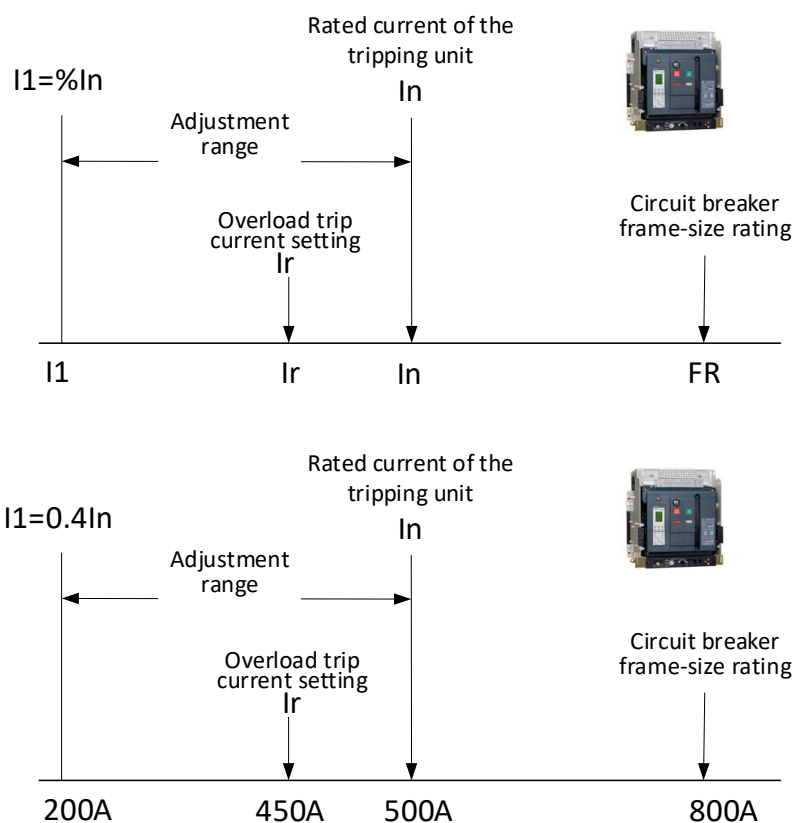

Figure 3.59 – Circuit Breaker - Overload relay trip-current setting.

General case above and example below showing a CB with current rating 500A, I_r adjusted to 0.9 of I_n . Adjustment interval presented for $0.4 \leq I_r \leq 1$.

Source: EMSA

- **Short-circuit relay trip-current setting (I_m)** – Short-circuit tripping relays (instantaneous or slightly time-delayed) are intended to trip the circuit breaker rapidly on the occurrence of high values of fault current. There is a wide variety of tripping devices which allow a user to adapt the protective performance of the circuit breaker to the particular requirements of a load.
- **Suitability for Isolation** – A circuit breaker is suitable for isolating a circuit if it fulfils all the conditions prescribed for a disconnectors:
 - All poles of a circuit, including the neutral, must open
 - It must be provided with a locking system in open position with a key (e.g., by means of a padlock or built-in lock) in order to avoid an unauthorized reclosure by inadvertence
 - It must comply with a recognized national or international standard (e.g., IEC 60947-3, IEC 62271-200)
 - Verification that the contacts of the isolating device are, in fact, open (directly visible contactors or via direct mechanical indicator)
 - Comply with leakage current max thresholds (typically of few mA)
 - Voltage-surge withstand capacity.

- Rated short-circuit breaking capacity (I_{cu}) - The short-circuit current-breaking rating of a CB is the highest (prospective) value of current that the CB is capable of breaking without being damaged. This rated value (I_{cu}) is normally given in kA rms.

I_{cu} (rated ultimate short circuit breaking capacity) and I_{cs} (rated service short circuit breaking capacity) are defined in IEC 60947-2 together with a table relating I_{cs} with I_{cu} for different categories of utilization A (instantaneous tripping) and B (time-delayed tripping)

- Rated service short-circuit breaking capacity (I_{cs}) - The rated breaking capacity (I_{cu}) is the maximum fault-current a circuit breaker can successfully interrupt without being damaged. The probability of such a current occurring is extremely low, and in normal circumstances the fault-currents are considerably less than the rated breaking capacity (I_{cu}) of the CB. On the other hand, it is important that high currents (of low probability) be interrupted under good conditions, so that the CB is immediately available for reclosure, after the faulty circuit has been repaired. It is for these reasons that a new characteristic (I_{cs}) has been created, expressed as a percentage of I_{cu} .
- Fault-current limitation - The fault-current limitation capacity of a CB relates to its ability to prevent the passage of the maximum prospective fault-current, permitting only a limited amount of current to flow, as shown in the figure below.

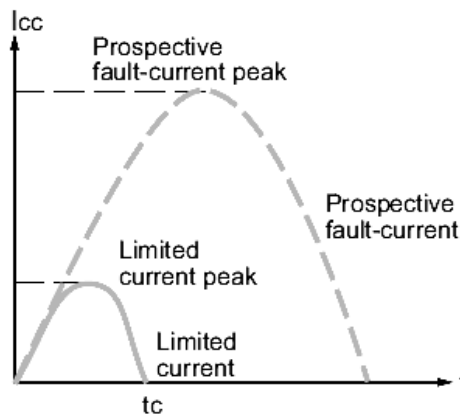

Figure 3.60 – Prospective and actual currents.

Source: EMSA

The advantages of current limitation

- Better conservation of installation networks: current-limiting CBs strongly attenuate all harmful effects associated with short-circuit currents
- Reduction of thermal effects: Conductors (and therefore insulation) heating is significantly reduced, so that the life of cables is correspondingly increased
- Reduction of mechanical effects: forces due to electromagnetic repulsion are lower, with less risk of deformation and possible rupture, excessive burning of contacts, etc.
- Reduction of electromagnetic-interference effects - Less influence on measuring instruments and associated circuits, telecommunication systems, etc.
- Contribute towards an improved exploitation of:
 - ✓ Cables and wiring
 - ✓ Prefabricated cable-trunking systems
 - ✓ Switchgear, thereby reducing the ageing of the installation

3.6.4 Properties

As demonstrated in the previous section, the basic function of a Circuit Breaker (CB) is to break/make the continuity of the circuit. The main factors affecting the choice of a CB are rated current, short-circuit current calculated for the circuit, voltage (high voltage requiring arc prevention protection), location, earth fault monitoring, tripping setup ranges.

Circuit breakers are therefore mechanical switching devices able to make, continuously carry and interrupt currents under normal circuit conditions and also within a limited time under abnormal conditions, such as short circuits.

Compromise is needed both on economic grounds, taking into account probability of certain conditions, and on technical grounds involving consideration of lower or higher speeds, of heavy or low current operation and many other opposing influences (e.g., maximum operating voltage and current at location, system frequency, duration of short circuit, switching cycle and climatic conditions).

The basic elements of circuit breakers are operating mechanism, insulators, interrupting chamber(s), capacitor, and resistor.

The main types of circuit breakers include the following:

1. Bulk oil
2. Minimum oil
3. Air
4. Air blast
5. Sulphur hexafluoride (SF6)
6. Vacuum
7. Explosive

A circuit breaker is designed to detect and switch a short-circuit current and overload current when applicable.

A small miniature circuit breaker with a nominal rating of 16A can interrupt a short circuit current of 6000A, which is nearly 400 times the nominal current, however this can only be done a few times.



Figure 3.61 – Different panels of a distribution low-voltage switchboard.

Each panel is presented with a circuit breaker. Each panel is, in this case either an incoming panel or an outgoing panel, in which case power load demand is taken and monitored/protected through each circuit breaker.

Circuit breakers are electromechanical switch units, equipped with microprocessors which control the release/trip characteristics of each unit. Through the mechanical or digital setting of tripping values, it is possible to provide the circuit breaker with a more or less “sensitive” response to short-circuits (amperage and time), overloads and earth/ground faults.

This is achieved through the adjustment of tripping units in the circuit breaker.

The main objective of circuit breaker tripping units and protective functions in general is **to detect faults** and to selectively isolate faulted parts of the system. It must also permit short clearance times to limit the fault power and the effect of arcing faults.

The protective function of the circuit breaker in the power distribution system is determined by the selection of the appropriate release/trip setting (see figure 2.55). Releases can be divided into:

1. Thermal-magnetic tripping units – TMTU, also called electromechanical releases and
2. Electronic tripping units – ETU

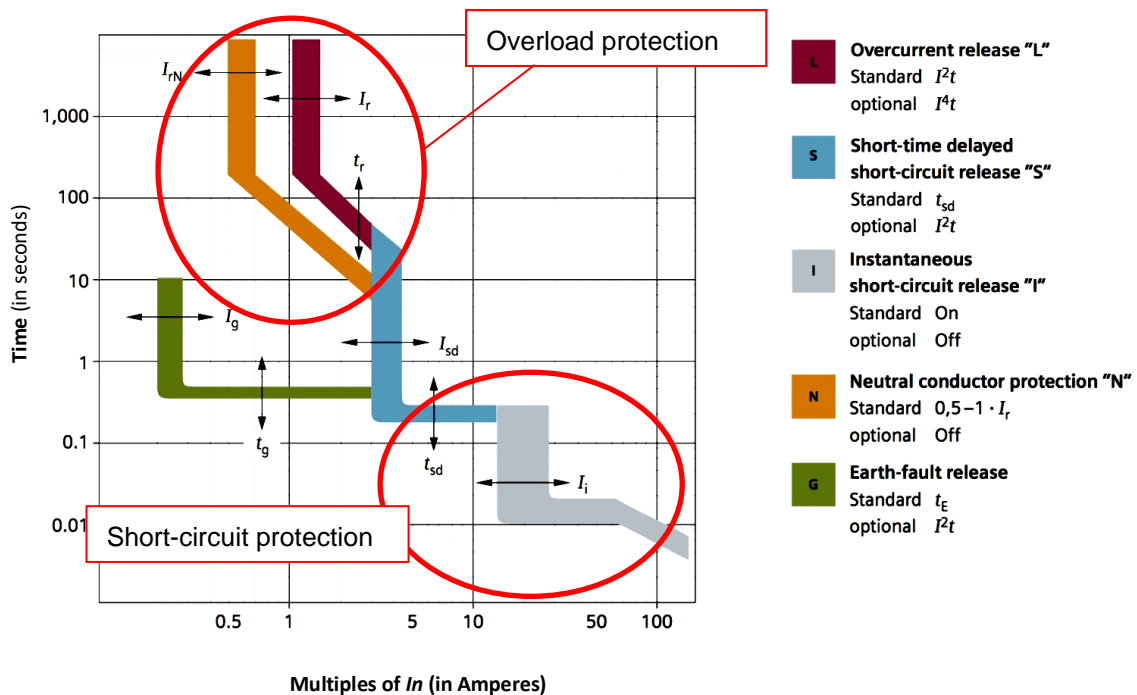

Figure 3.62 – Variants of circuit breaker tripping curves.

The two main areas in the graph indicate the Overload Protection settings and Short-circuit protection.

The electromechanical releases are based on a direct physical translation of the monitored/protected circuit. Physical parameters are directly measured, and the tripping of the Circuit Breaker occurs in accordance with a pre-set point of the equipment. The electronic trip units instead use **a microprocessor to process the current signal** and operate the circuit breaker opening in case of fault. In addition to this, **electronic tripping units offer more tripping criteria** which are not feasible with electromechanical releases.

By digital processing of the signal, Circuit Breakers provide the following protection functions:

- Long time-delay trip function (code⁸: 51, AC time overcurrent relay).
- Short time-delay trip function (code: 51, AC time overcurrent relay).
- Instantaneous trip function (code: 50, instantaneous overcurrent relay).
- Ground-fault trip function (code: 51 N, AC time earth fault overcurrent relay).

⁸ [IEEE](#) Standard C37.2 Standard for Electrical Power System Device Function Numbers, Acronyms, and Contact Designations

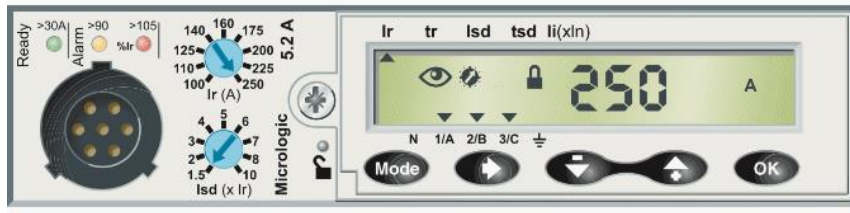

Figure 3.63 – Microprocessor tripping unit.

Overloads: Long time protection (Ir); Short-circuits: Short-time protection (Isd); Short-circuits: Instantaneous protection (Ii), Additional ground fault protection (Ig) and Neutral protection.

Source: Schneider Electric

The following table presents an overall summary of the trip protections of the circuit breaker.

Table 3.14: Summary of the trip protections of circuit breakers.

Tripping units		Short description
Thermal-magnetic tripping units	Thermal trip unit –	Made up by a bimetal thermal device which actuates the opening of a circuit breaker with a delay depending on the overcurrent value. This trip unit is intended for the protection against overloads .
	Magnetic trip unit	Made up by an electromagnetic device, with fixed (fixed instantaneous trip) or adjustable (adjustable instantaneous trip) threshold, which actuates the instantaneous trip of the circuit breaker on a pre-determined overcurrent value (multiple of the nominal current, In) with a constant trip time (about some tens of milliseconds). This trip unit is intended for the protection against short circuit.
Electronic tripping units	Overload protection	Designation: L (LT: long-time delay) Depending on the type of release, inverse-time-delay overload releases are also available with optional characteristic curves. This adjustable function simulates the effect of a bimetal conductor in a thermal-magnetic circuit breaker. It reacts to overload conditions and determines how much current the circuit breaker will carry continuously. The nominal pickup point where a circuit breaker trip unit detects an overload is at 1.075 times the selected ampere rating. After the circuit breaker has picked up, it will not trip until the delay determined by the long-time delay adjustment has been achieved.
	Neutral conductor protection	Inverse-time-delay overload releases for neutral conductors are available in a 50% or 100% ratio of the overload release. The neutral must have specific protection if: <ul style="list-style-type: none"> • It is reduced in size compared to the phases⁹ • Nonlinear loads generating third order harmonics are installed <p>It may be necessary to cut off the neutral for functional reasons (multiple source diagram) or safety reasons (working with power off).</p>

⁹ This is the case with the connector for HVSC Cruise ships – IEC/IEEE 80005-1 Annex - C

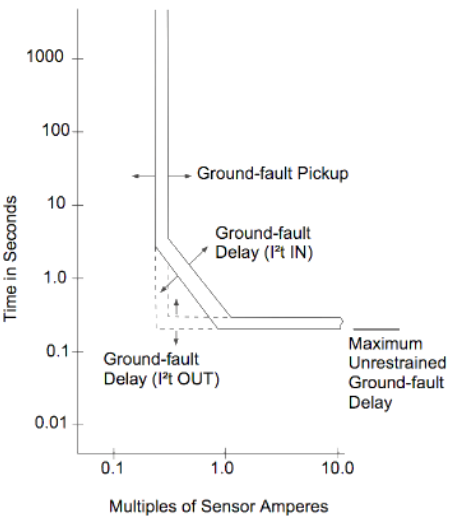
	<p>Short-circuit protection, instantaneous</p>	<p>Designation: I (INST: instantaneous)</p> <p>Depending on the application, I-releases can either be used with a fixed or an adjustable release current I_i as well as with a switch-off or non-switch-off function.</p> <p>The instantaneous pickup function simulates the magnetic characteristic of a thermal-magnetic circuit breaker. This function trips the circuit breaker <u>with no intentional time delay</u>.</p> <p>In circuit breakers with both short-time and instantaneous pickup, the instantaneous pickup will override the short-time pickup if the instantaneous pickup is set at the same or lower setting than the short-time pickup.</p>
	<p>Short-circuit protection, delayed</p>	<p>Designation: S (ST: short-time delay)</p> <p>To be used for a time adjustment of protective functions in series. Besides the standard curves and settings, there are also optional functions for special applications:</p> <p>Definite-time overcurrent releases</p> <p>For this "standard S function", the desired delay time (t_{sd}) is defined as of a set current value (threshold I_{sd}) (definite time, similar to the function of "definite-time overcurrent-time protection (DMT)" at the medium voltage level).</p> <p>Inverse-time overcurrent releases</p> <p>In this optional S function, the product of I^2t is always constant. In general, this function is used to improve the selectivity response (inverse time, similar to the function of "inverse-time overcurrent-time protection" at the medium voltage level).</p>
	<p>Earth-fault protection</p>	<p>Designation: G (GF: ground fault)</p> <p>Besides the standard function (definite-time) an optional function (I^2t = current-dependent delay) is also available.</p>  <p>Figure 3.64 – Ground-fault characteristic curve.</p> <p>The ground-fault function is divided into pickup and delay components (see Figure 3.64). The pickup portion determines at what point the circuit breaker will begin detecting a ground fault.</p>

		<p>The delay adjustment determines how long the circuit breaker will delay tripping after a ground-fault has been detected. It is supplied with both an “I_{Δt} IN” and an “I_{Δt} OUT” function on the circuit breakers.</p> <p>In a circuit breaker with the ground-fault function, there is a maximum unrestrained ground-fault delay provided. This delay determines the maximum amount of time the circuit breaker will delay during a ground-fault condition when not restrained by a downstream breaker. The maximum delay is shown by a single line and stays constant for all ground-fault delay switch settings.</p>
	<p>Fault-current protection</p>	<p>Designation: RCD (residual current device)</p> <p>It detects differential fault currents up to 3 A, similar to the FI function for personal protection (max. 500 mA).</p>

3.6.5 Selection of a circuit breaker for SSE

The choice of a circuit breaker for applications in SSE-OPS installations should comply with the technical and operating requirements laid out in IEC/IEEE 80005-1/3:

- i. **Electrical characteristics** (AC or DC, Voltage...) of the installation for which the CB is intended
- ii. **Environmental Factors**: ambient temperature, in a switchboard enclosure, climatic conditions, amongst others.
- iii. **Presumed/prospective short-circuit current** at the point of installation.

As per section 4.7 of IEC/IEEE 80005-1/3, for HVSC and LVSC respectively - The prospective short-circuit contribution level from the HV shore distribution system shall be limited by the shore-side system to 16 kA RMS, unless otherwise specified in the ship-specific annexes.

The prospective short-circuit contribution level from the onboard running induction motors and the generators in operation shall be limited to a short-circuit current of 16 kA RMS, unless otherwise specified in the ship type's specific annexes.

Electrical system/equipment, including short-circuit protective device rating, shall be suitable for the prospective maximum short-circuit fault current. Equipment shall be rated for minimum short-circuit withstand current of 16 kA RMS for 1 s, and 40 kA peak, unless otherwise specified in the ship specific annexes.

Ship specific requirements include:

- RO-Pax, Containerships and Tankers: The short-circuit withstand current is 16 kA RMS for 1 s and a maximum peak short-circuit current of 40 kA
- Cruise ships and LNG carriers:
 - o The prospective short-circuit contribution level from the HV shore distribution system shall be limited by the shore-sided system to 25 kA RMS.
 - o The prospective short-circuit contribution level from the onboard running induction motors and the generators in operation shall be limited to a short-circuit current of 25 kA RMS.

The above reflects in a rating requirement for the Circuit Breaker (and any other decided switching gear) corresponding to the following, as per IEC/IEEE80005-1/3:

The rated making capacity of the circuit breaker and the earthing switch shall not be less than the prospective peak value of the short-circuit current (IP) calculated in accordance with IEC 61363-1.

The rated short-circuit breaking capacity of the circuit-breaker shall not be less than the maximum prospective symmetrical short-circuit current ($I_{AC(0,5T)}$) calculated in accordance with IEC 61363-1.

Notes:

- *The short circuit contribution from the shore side can be calculated using IEC 60909.*
- *Additional recommendations are provided in IEEE 551-2006 - Recommended Practice for Calculating AC Short-Circuit Currents in Industrial and Commercial Power Systems*

The rated making capacity of the circuit breaker and the earthing switch shall not be less than the prospective peak value of the short-circuit current (IP) calculated in accordance with IEC 61363-1.

- iv. **Specific HV interlocking requirement** - In order to have the installation isolated before it is earthed, the circuit-breaker, disconnecter and earthing switch shall be interlocked in accordance with IEC 62271200 (IEC/IEEE 80005-1, 6.2.1).
- v. **Characteristics of the protected** cables, busbars, busbar trunking system and application (with particular view for the ship-specific/terminal HVSC/LVSC applications where different load profiles from the ship side may be present).
- vi. **Coordination** with upstream and/or downstream device: selectivity, cascading, coordination with switch disconnecter, contactor or other. Safety loops on HVSC and LVSC systems ensure coordination of the installed shore-side and ship-side circuit breakers. Safety circuits are physically laid out through the pilot contact of the power connectors.
- vii. **Selectivity:** Circuit breaker to be selected in obedience with the general selectivity requirement indicated in IEC/IEEE 80005-1, section 6.1:

The use of HVSC system shall not compromise the electrical protection selectivity of the largest on-board load (as per the definition in IEC 60050-151:2001, 151-15-15) while connected.

This is an important requirement which should be taken into consideration in the selection of the shore-side feeder circuit breaker. It imposes a minimum short circuit rating for the shore-side installation.

- viii. **Operational specifications:** requirements (or not) for remote control and indication and related auxiliary contacts, auxiliary tripping coils, connection

As per IEC/IEEE 80005-1 section 6.2.1, shore-power circuit breaker shall be automatically operated.

- ix. **Installation regulations:** in particular: protection against electric shock and thermal effect (Important to take local regulations into consideration)
- x. **Load characteristics,**

3.6.5.1 Selection of a circuit breaker according to the prospective short-circuit

The installation of a circuit breaker in a LV installation must fulfil one of the two following conditions:

1. Either have a rated short-circuit breaking capacity ***I_{cu}*** which is equal to or exceeds the prospective short-circuit current calculated for its point of installation, or
2. If this is not the case, be associated with another device which is located upstream, and which has the required short-circuit breaking capacity

In the second case, the characteristics of the two devices must be coordinated such that the energy permitted to pass through the upstream device must not exceed that which the downstream device and all associated cables, wires and other components can withstand, without being damaged in any way.

This technique is effectively employed in:

- Associations of fuses and circuit breakers
- Associations of current-limiting circuit breakers. The technique is known as “cascading”

3.6.5.2 Circuit breakers for Parallel Transformer installations

The figures below present a power supply installation with parallel transformers. It is important to select the circuit breakers to install with a view to withstand the maximum short-circuit current that can be expected under different fault conditions.

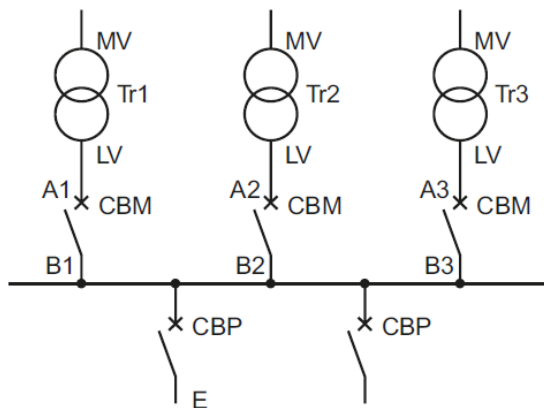

Figure 3.65 – Transformers in parallel (Three transformers feeding a bus bar through 3 main feeder circuit breakers (CBM) with 2 Principal Circuit Breakers (CBP))

Source: EMSA

The feeder circuit breakers (Principal Circuit Breakers – CBP) must each be capable of breaking the total fault current from all transformers connected to the busbars: **$I_{sc1} + I_{sc2} + I_{sc3}$**

The main incomer circuit breakers CBM, must be capable of dealing with a maximum short-circuit current of (for example) $I_{sc2} + I_{sc3}$ only, for a short-circuit located on the upstream side of CBM1.

From these considerations, it will be seen that the circuit breaker of the smallest transformer will be subjected to the highest level of fault current in these circumstances, while the circuit breaker of the largest transformer will pass the lowest level of short-circuit current

The ratings of CBMs must be chosen according to the kVA ratings of the associated transformers.

Note: The essential conditions for the successful operation of 3-phase transformers in parallel may be summarized as follows:

1. the phase shift of the voltages, primary to secondary, must be the same in all units to be paralleled.
2. the open-circuit voltage ratios, primary to secondary, must be the same in all units.
3. the short-circuit impedance voltage ($Z_{sc}\%$) must be the same for all units.

For example, a 750kVA transformer with a $Z_{sc} = 6\%$ will share the load correctly with a 1,000kVA transformer having a Z_{sc} of 6%, i.e. the transformers will be loaded automatically in proportion to their kVA ratings. For transformers having a ratio of kVA ratings exceeding 2, parallel operation is not recommended.

3.6.6 Coordination between circuit breakers

A. Cascading or Back-up protection

Definition: By limiting the peak value of short-circuit current passing through it, a current limiting CB permits the use, in all circuits downstream of its location, of switchgear and circuit components having much lower short-circuit breaking capacities, and thermal and electromechanical withstand capabilities than would otherwise be necessary. Reduced physical size and lower performance requirements lead to substantial economy and to the simplification of installation work.

B. Conditions of implementation

Most national standards admit the cascading technique, on condition that the amount of energy “let through” by the limiting CB is less than the energy all downstream CBs and components are able to withstand without damage. In practice this can only be verified for CBs by tests performed in a laboratory.

Such tests are carried out by manufacturers who provide the information in the form of tables, so that users can confidently design a cascading scheme based on the combination of recommended circuit breaker types.

C. Advantages of cascading

The current limitation benefits all downstream circuits that are controlled by the current-limiting CB concerned.

The principle is not restrictive, i.e. current-limiting CBs can be installed at any point in an installation where the downstream circuits would otherwise be inadequately rated.

The result is:

- Simplified short-circuit current calculations
- Simplification, i.e. a wider choice of downstream switchgear and appliances
- The use of lighter-duty switchgear and appliances, with consequently lower cost
- Economy of space requirements, since light-duty equipment have generally a smaller volume

D. Selectivity

Selectivity is achieved by overcurrent and earth fault protective devices if a fault condition, occurring at any point in the installation, is cleared by the protective device located immediately upstream of the fault, while all other protective devices remain unaffected (see Figure 3.66).

Selectivity is required for installation supplying critical loads where one fault on one circuit shall not cause the interruption of the supply of other circuits.

In SSE installations, selectivity is important in particular for the cases where more than one supply point is supplied by the power supply. It is important to implement segregation of the supply points, giving a criticality score to different connection points. This may be related to ship type (e.g. RO-Pax, cruise ships, tankers, etc) or to the load profile.

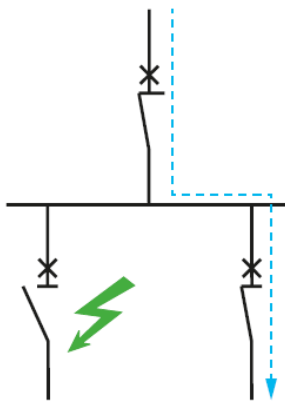

Figure 3.66 – Principle of selectivity [15].

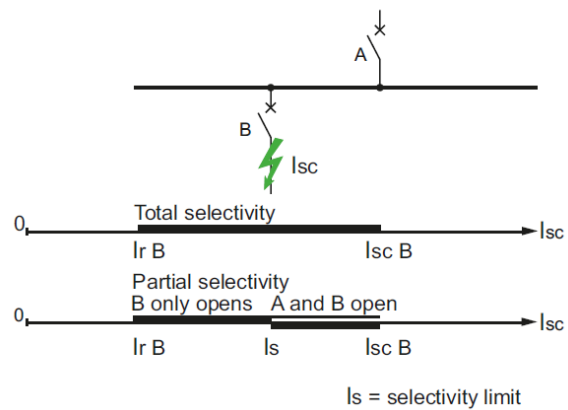

Figure 3.67 – Total and partial selectivity [15].

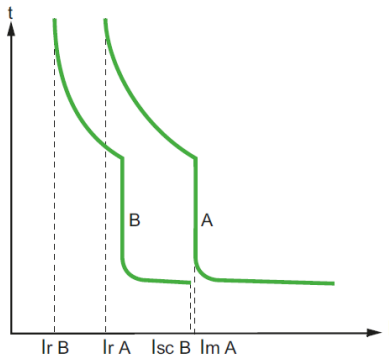

Figure 3.68 – Total selectivity between CBs A and B [15].

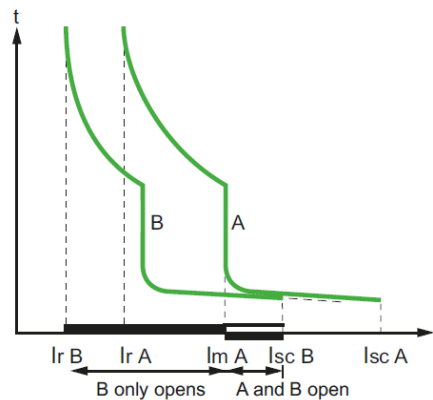

Figure 3.69 – Partial selectivity between CBs A and B [15].

From installation point of view: Selectivity is achieved when the maximum short-circuit current at a point of installation is below selectivity limit of the circuit breakers supplying this point of installation. Selectivity shall be checked for all circuits supplied by one source and for all type of fault:

- Overload
- Short-circuit
- Earth fault

When system can be supplied by different sources (grid or generator set for instance) selectivity shall be checked in both cases.

Selectivity between two circuit breakers may be

- Total: up to the breaking capacity of the downstream circuit breaker
- Partial: up to a specified value according to circuit breakers characteristics

E. Current based selectivity (Figure 3.70):

This method is realized by setting successive tripping thresholds at stepped levels, from downstream circuits (lower settings) towards the source (higher settings).

Selectivity is total or partial, depending on particular conditions, as noted above.

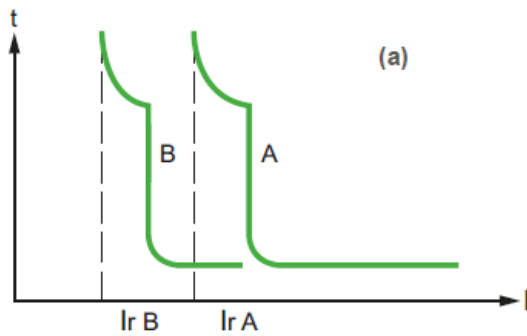
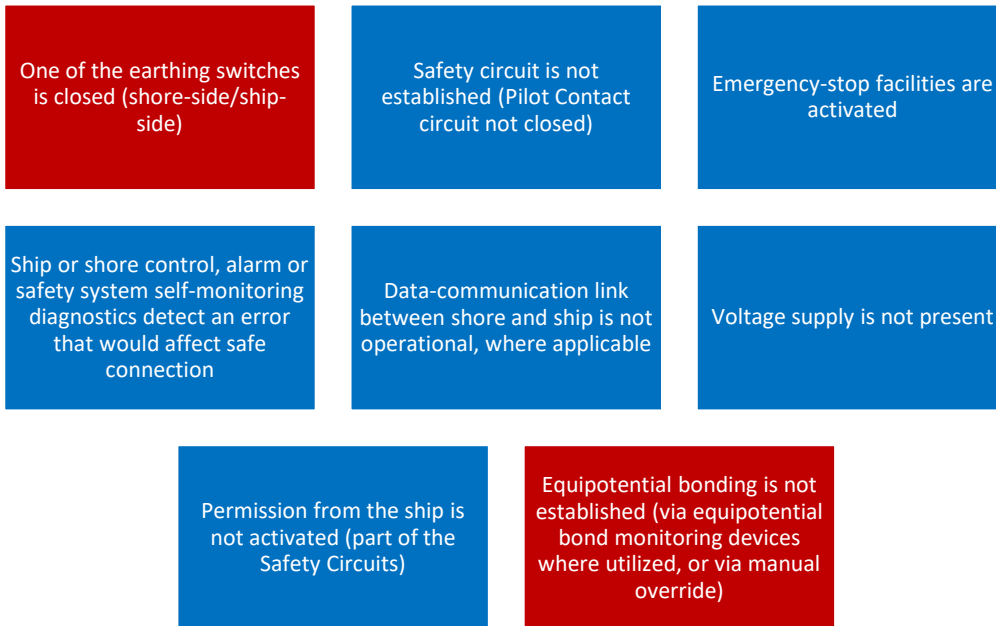

Figure 3.70 – Current based selectivity [15].

3.6.7 Operating requirements for circuit breakers in IEC/IEEE- 80005

The following conditions should lead to the impossibility to close shore power **circuit breakers** (red boxes for HV circuit breakers, blue boxes for both HV and LV):



To the above conditions, as described in section 6.4.2 of both standards IEC/IEEE 80005-1 and 3 there is an important note to be made: Whereas the LVSC standard clearly highlights the requirement for circuit breakers with incorporated disconnecter function, this is not the case in the HV version. In section 6.4.2 of IEC/IEEE80005-1 the conditions for allowing the closing of the disconnecter (or the circuit breaker racked into the service position) are stated separately as follows:

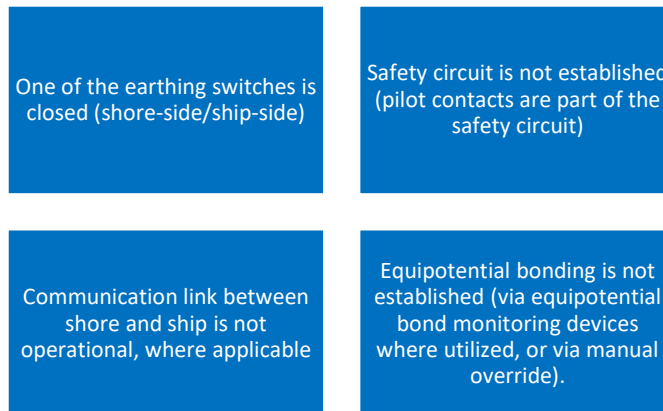

Furthermore, also for the HVSC, opening of earthing switches shall be conditional to interlocking and only possible following confirmation of all the following conditions:

- all connections are made, and the pilot contact/safety circuit is closed,
- no emergency-stop switch is activated,
- communication link between shore and ship is operational,
- ship or shore control, alarm or safety system self-monitoring properties detects that no failure would affect the safety of connections, and
- permission from ship and shore is activated.

Switching gear should have built-in characteristics, or alternative arrangements should be provided so that one any of the above conditions is verified it shall not be possible to close the devices.

3.7 Transformers

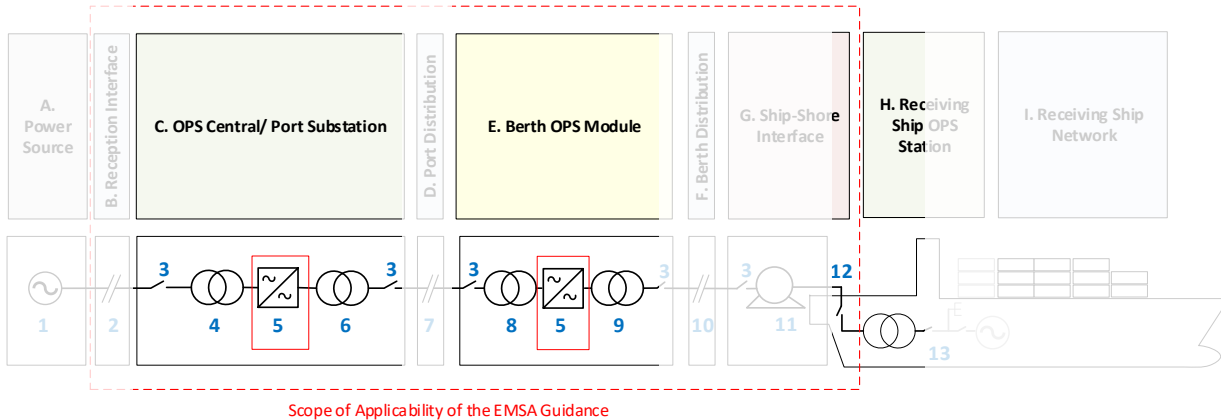

Figure 3.71 - Relevant key Transformer locations – Central OPS substation and Berth OPS Module.



Source: EMSA



This section provides an overview of the important role of transformers in SSE installations

3.7.1 Transformers in SSE

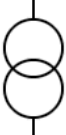
Different types of transformers can be used in SSE installations for a variety of applications – see Table 3.15.

Table 3.15: Types of transformers for use in SSE.

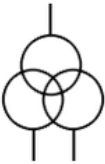
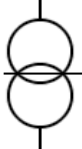
Type of transformers	Symbol	Description	Application in SSE
Voltage transformer	<p>Voltage transformer Two windings are shown Generic symbol</p>  <p>Example with more detail Three-phase transformer with star / delta connection</p> 	<p>Voltage step-up or step-down of tri-phasic AC voltage is achieved in practice through the use of 3-phase transformers with different configurations.</p> <p>For a three-phase transformer, the three primary windings are connected together, and the three secondary windings are connected together.</p>	<ul style="list-style-type: none"> Applied to step-up or step-down the incoming voltage. Voltage Step-down of incoming utility grid voltage. Voltage Step-down for distribution or supply to frequency converter. Voltage Step-up following frequency conversion

<p>Three-winding Transformers</p>		<p>Three winding transformers are voltage transformers that are able to transform the primary voltage into two different “output voltages”, varying according to the number of wire turns on each winding.</p> <p>A practical aspect of 3-winding transformers is that it may represent a more economic and efficient way to step-down HV into two separate values</p>	<ul style="list-style-type: none"> • Voltage Step Down with 2 different output voltages. • Particularly relevant after Frequency Conversion if two different supply voltages are intended.
<p>Isolation Transformers</p>		<p>An isolation transformer links two circuits magnetically but provides no metallic conductive path between the circuits.</p> <p>It is used when it is necessary to prevent isolation between two separate circuits, where one feeds the other with specified voltage but with no current flowing across.</p>	<ul style="list-style-type: none"> • Galvanic isolation is mandatory for HVSC and LVSC, in accordance with IEC/IEEE 80005-1 and 3, respectively. • All transformers provide isolation (except auto transformers).
<p>Auto Transformers</p>		<p>An autotransformer consists only one winding that is tapped at some point along the winding. Voltage is applied across a terminal of the winding, and a higher (or lower) voltage is produced across another portion of the same winding.</p> <p>For voltage ratios that don't exceed about 3:1, an autotransformer is cheaper, lighter, smaller, and more efficient than an isolating (two-winding) transformer of the same rating.[3] Large three-phase autotransformers are used in electric power distribution systems, for example, to interconnect 220 kV and 33 kV sub-transmission networks or other high voltage levels</p>	<ul style="list-style-type: none"> • Can be used as an economic option for incoming station where utility grid power is received. • NOTE: cannot provide isolation
<p>Transformer Chargers</p>	<p>No symbol</p>	<p>A transformer-charger is, in fact, an electrical setup including a transformer and a rectifying circuit.</p> <p>Transformer-chargers are used to charge batteries either onboard or ashore.</p>	<p>Battery charging</p>
<p>Solid-State Transformers</p>		<p>A solid-state transformer is actually a power converter that performs the same function as a</p>	<p>May present advantageous applications in projects where DC and AC grid</p>

		conventional transformer, sometimes with added functionality. Most contain a smaller high-frequency transformer. It can consist of an AC-to-AC converter, or a rectifier powering an inverter.	<p>interfaces with high frequency isolation is required.</p> <p>Integration of renewables with power quality management.</p> <p>High Frequency interface may allow for optimum volume designs.</p> <p>Elimination of higher frequency harmonics.</p>
Grounding Transformer		<p>A grounding transformer or earthing transformer is a type of auxiliary transformer used in three-phase electric power systems to provide a ground path to either an ungrounded wye or a delta-connected system.</p> <p>Grounding transformers are part of an earthing system of the network. They let three-phase (delta connected) systems accommodate phase-to-neutral loads by providing a return path for current to a neutral.</p>	<p>May be used as part of a shore power earthing system</p> <p>Provide a relatively low-impedance path to ground, thereby maintaining the system neutral at or near ground potential.</p>

3.7.1.1 Basics

The reason for using a voltage of a much higher level is that higher distribution voltages imply lower currents for the same power.

These higher AC transmission voltages and currents can then be reduced to a much lower, safer, and usable voltage level where it can be used to supply electrical equipment, all this is possible thanks to the transformer.

A transformer basically is an electro-magnetic passive electrical device that works on the principle of Faraday's law of induction by converting electrical energy from one value to another. The transformer does this by linking together two or more electrical circuits using a common oscillating magnetic circuit which is produced by the transformer itself. A transformer operates on the principals of electromagnetic induction. By induction a coil of wire magnetically induces a voltage into another coil located near it. We can say that transformers work in the magnetic domain, and transformers get their name from the fact that they transform one voltage or current level into another.

Transformers are capable of either increasing or decreasing the voltage and current levels of their supply, without modifying its frequency, or the amount of Electrical Power being transferred from one winding to another via the magnetic circuit.

A single-phase voltage transformer basically consists of two electrical coils of wire, one called the Primary Winding, and another called the Secondary Winding. We will define the primary side of the transformer as the side that usually takes power, and the secondary as the side that usually delivers power. In a single-phase voltage transformer, the primary is usually the side with the higher voltage.

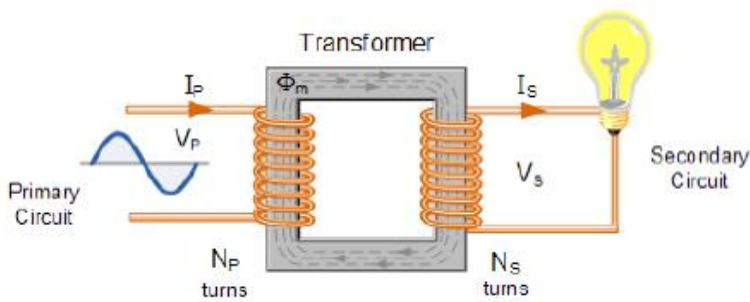

Figure 3.72 – Transformer – Simplified diagram.

These two coils are not in electrical contact with each other but are instead wrapped together around a common closed magnetic iron circuit called the core. This soft iron core is not solid but made up of individual laminations connected together to help reduce the core's losses.

The two coil windings are electrically isolated from each other but are magnetically linked through the common core allowing electrical power to be transferred from one coil to the other. When an electric current passed through the primary winding, a magnetic field is developed which induces a voltage into the secondary winding as shown.

When for a transformer there is no direct electrical connection between the two coil windings the transformer acts as a galvanic isolator.

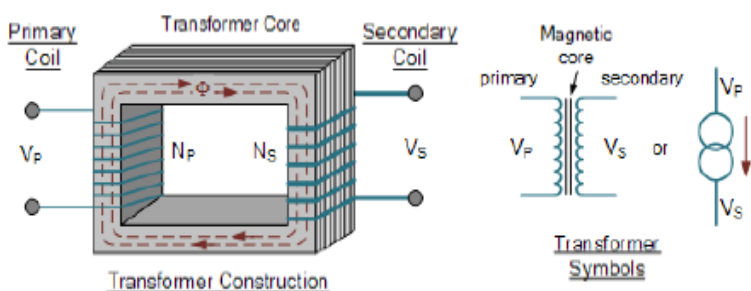

Figure 3.73- Transformer – Simplified diagram – representation of transformer main elements.

The two coil windings are not electrically connected but are only linked magnetically. A single-phase transformer can operate to either increase or decrease the voltage applied to the primary winding.

However, a third condition exists in which a transformer produces the same voltage on its secondary as is applied to its primary winding. In other words, its output is identical with respect to voltage, current and power transferred. This type of transformer is mainly used for impedance matching or the isolation of adjoining electrical circuits.

The difference in voltage between the primary and the secondary windings is achieved by changing the number of coil turns in the primary winding (N_P) compared to the number of coil turns on the secondary winding (N_S).

As the transformer is basically a linear device, a ratio now exists between the number of turns of the primary coil divided by the number of turns of the secondary coil. This ratio is called turns ratio, (TR).

It is necessary to know the ratio of the number of turns of wire on the primary winding compared to the secondary winding. The turns ratio, which has no units, compares the two windings in order and is written with a colon, such as 3:1 (3-to-1). This means in this example, that if there are 3 volts on the primary winding there will be 1 volt on the secondary winding, 3 volts-to-1 volt. Then we can see that if the ratio between the number of turns changes the resulting voltages must also change by the same ratio, and this is true.

Transformers are all about ratios. The ratio of the primary to the secondary, the ratio of the input to the output, and the turns ratio of any given transformer will be the same as its voltage ratio. In other words, for a transformer turns ratio = voltage ratio. The actual number of turns of wire on any winding is generally not important, just the turns ratio and this relationship is given as:

$$\frac{N_P}{N_S} = \frac{V_P}{V_S} = n = \text{turns ratio}$$

As the input power equals the output power, we can also say that: turns ratio is the inverse of the current ratio.

$$\frac{N_P}{N_S} = \frac{V_P}{V_S} = \frac{I_S}{I_P} = n$$

3.7.1.2 Transformers in parallel connection

For supplying a load in excess of the rating of an existing transformer, two or more transformers may be connected in parallel with the existing transformer. The transformers are connected in parallel when load on one of the transformers is more than its capacity.

The reliability is increased with parallel operation than to have single larger unit.

The cost associated with maintaining the spares is less when two transformers are connected in parallel. It is usually economical to install another transformer in parallel instead of replacing the existing transformer by a single larger unit.

The cost of a spare unit in the case of two parallel transformers (of equal rating) is also lower than that of a single large transformer. In addition, it is preferable to have a parallel transformer for the reason of reliability.

With this at least half the load can be supplied with one transformer out of service.

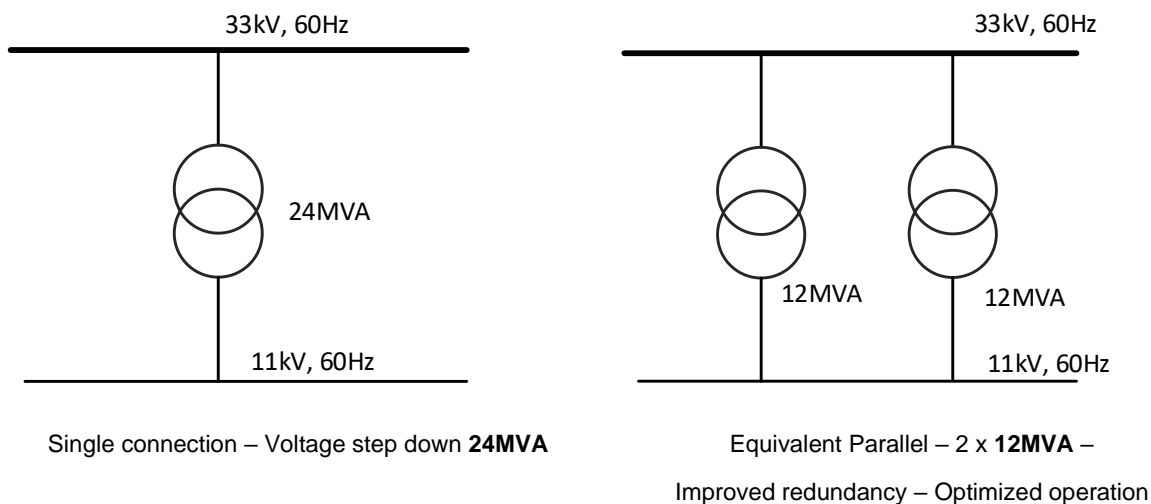

The informative annex of the IEC 60076-1 mentions it should be noted that while parallel operation is not unusual, it is advisable that users consult the manufacturer when paralleling with other transformers is planned and identify the transformers involved. If for a new transformer, parallel operation with existing transformer(s) is required, this shall be stated and the following information on the existing transformer(s) given:

- Rated power.
- Rated voltage ratio.

- Voltage ratios corresponding to tapplings other than the principal tapping.
- Load loss at rated current on the principal tapping, corrected to the appropriate reference temperature.
- Short-circuit impedance on the principal tapping and on the extreme tapplings, if the voltage on the extreme tapplings is more than 5 % different to the principal tapping.
- Impedance on other tapplings if available.
- Diagram of connections, or connection symbol, or both.

In the context of the present Guidance, parallel operation means direct terminal-to-terminal connection between transformers in the same installations. Only two-winding transformers are considered. This logic is also applicable to banks of three single-phase transformers. For successful parallel operation, the transformers require:

- the same phase-angle relation – clock-hour number (additional possible combinations are mentioned below).
- the same ratio with some tolerance and similar tapping range.
- the same relative short-circuit impedance – percentage impedance – with some tolerance. This also means that the variation of relative impedance across the tapping range should be similar for the two transformers.

These three conditions are elaborated further in the following sub-sections.

At enquiry stage, it is important that the specification for a transformer, which is intended for parallel operation with a specific existing transformer, contain the existing transformer information.

Some warnings are prudent in this connection.

- It is not advisable to combine transformers of widely different power rating (say, more than 1:2). The natural relative impedance for optimal designs varies with the size of the transformer.
- Transformers built according to different design concepts are likely to present different impedance levels and different variation trends across the tapping range

Conditions for Parallel Operation of Transformer

The table below summarises the convenient and mandatory conditions for parallel operation of transformers:

Table 3.16 – Conditions for parallel operation of transformers.

Conditions for Parallel Operation of Transformers	Convenient	Mandatory
Same voltage and Turns Ratio (both primary and secondary voltage rating is same)	X	
Same Percentage Impedance and X/R ratio	X	
Identical Position of Tap changer	X	
Same KVA ratings	X	
Same Phase angle shift (vector group are same)		X
Same Frequency rating		X
Same Polarity		X
Same Phase sequence		X

Example

Let us assume that three transformers operate in parallel. The first transformer has 800 kVA rated power and 4.4% short-circuit impedance. The rated power and the short-circuit impedance of the other two transformers is 500 kVA and 4.8%, and 315 kVA and 4.0%, respectively.

Calculate the maximum total load of the three transformers.

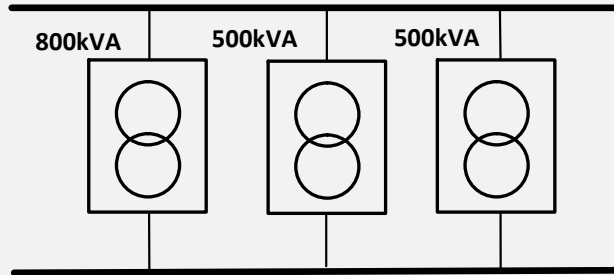

Among the three transformers, the third transformer has the minimum short-circuit impedance

- The load of transformer 1

$$P_{n,1} = P_1 \times (U_{k,\min}) / (U_{k,1}) = 800 \times 4 / 4.4 = 728 \text{ kVA}$$

- The load of transformer 2

$$P_{n,2} = P_2 \times (U_{k,\min}) / (U_{k,2}) = 500 \times 4 / 4.8 = 417 \text{ kVA}$$

- The load of transformer 3

$$P_{n,3} = P_3 \times (U_{k,\min}) / (U_{k,2}) = 315 \times 4 / 4 = 315 \text{ kVA}$$

- The maximum load of the three transformers is:

$$P_{\text{tot}} = P_{n,1} + P_{n,2} + P_{n,3} = 728 + 417 + 315 = 1460 \text{ kVA}$$

- The three transformers have total installed power:

$$P = P_1 + P_2 + P_3 = 800 + 500 + 315 = 1615 \text{ kVA}$$

From the above, it is concluded that the maximum total load (1460 kVA) represents the 90.4% of the total installed power (1615 kVA).

It should be noted that, in order the maximum total load to be equal to the total installed power, the transformers must have the same short-circuit impedance.

Parallel operation of transformers, or SFC units, is a key aspect to consider in SSE grid designs where different transformers may be arranged in parallel to ensure scalability and reliability in power supply. Selectivity must be ensured in parallel connected transformers, with Circuit Breakers arranged so as to protect all secondary windings.

In the event of tripping of one transformer circuit breaker, the other will be able to take load up to around 140-150% their rated power, for a limited period of time.

3.7.1.3 Oil Cooled, Dry Transformers and modular transforming stations

Transformers may be classified according to dielectric insulation material as follows:

- Oil-filled transformers
- Dry type transformers.



Figure 3.74 – Dry type transformer.

Source: ABB

Dry type transformers present the most suitable solution in situations where the distribution of energy requires optimized safety.

These transformers require less maintenance than oil-filled transformers, safer to environment and have optimum fire safety.

Windings and core are not installed in a tank and insulation of windings is usually made of cast resin.

They require less space, about 2/3 of that of corresponding oil filled transformers, and their simple construction allows on-site replacement of windings.

Dry Type transformers are not suitable for outdoor operation due to inadequate IP protection. For that reason, dry type always requires suitable protection module/container construction.

The construction limits for dry-type transformers can be considered as: maximum voltage 36 kV, maximum power of 20-25 MVA.



Figure 3.75 – Oil-filled transformer.

Source: ABB

Two types of oil-filled transformers are commonly used:

- With expansion tank (conservator)
- Sealed

In this type of transformers windings and core are immersed in oil, in a tank with radiators. Oil plays both functions of insulating material and cooling fluid.

Oil-filled sealed transformers (without conservator) are mainly used in distribution networks (MV/LV) and in installations up to 52 kV, with a rated power up to 2.5 MVA, although some manufacturers built this type of transformers up to 30 MVA. The degree of protection (IP) provided by the tank allows that both types of transformers can be installed outdoors.

In SSE installations, compact modular installations with enclosed transformer units are similar to the module presented in Figure 3.76.

These units are type tested assemblies comprising of an all-integrated transforming unit system within an enclosure containing Medium Voltage (MV) switchgear, Distribution transformers, Low Voltage (LV) switchboards, connections and auxiliary equipment.

These are typical units used for energy transformation in secondary distribution network from MV to LV or LV to MV systems.

These substations are typically installed in locations accessible to the public and should ensure protection for all people according to specified service conditions



Figure 3.76 – Compact substation for energy transformation.

Source: ABB

3.7.1.4 Power Transformers – Voltage Drop

The voltage drop is the arithmetic difference between the no-load voltage of a winding and the voltage developed at the terminals of the same winding at a specified load and power factor, with the voltage supplied to (one of) the other winding(s) being equal to:

- its rated value if the transformer is connected on the principal tapping (the no-load voltage of the winding is then equal to its rated value);
- the tapping voltage if the transformer is connected on another tapping.

This difference is generally expressed as a percentage of the no-load voltage of the winding.

Note: For multi-winding transformers, the voltage drop or rise depends not only on the load and power factor of the winding itself, but also on the load and power factor of the other windings (see IEC 60076-8).

The need for voltage drop calculation

The IEC definitions concerning rated power and rated voltage of a transformer imply that rated power is input power, and that the service voltage applied to the input terminals for the active power (the primary terminals) should not, in principle, exceed the rated voltage. The maximum output voltage under load is therefore a rated voltage (or tapping voltage) minus a voltage drop. The output power at rated current and rated input voltage is, in principle, the rated power minus the power consumption in the transformer (active power loss and reactive power).

By North America habits, the MVA rating is based on maintaining the rated secondary voltage by impressing on the primary winding the voltage necessary to compensate for the voltage drop across the transformer at rated secondary current and at a lagging power factor of 80 % or higher.

The determination of the corresponding rated voltage or tapping voltage, which is necessary to meet a specific output voltage at a specific loading, therefore involves a calculation of voltage drop, using known or estimated figures of transformer short-circuit impedance.

$$U_{drop} = \frac{S}{SB} \times (er \cos \varphi + ex \sin \varphi) + \frac{1}{2} \times \frac{1}{100} \times \left(\frac{S}{SB}\right)^2 \times (er \sin \varphi + ex \cos \varphi)^2$$

Where:

Resistive Part	$er = \frac{LL}{SB}$
Reactive Part	$ex = \sqrt{U_k^2 - er^2}$

Where:

U_{drop}	Voltage drop ratio at a percentage of load	%
LL	Load Losses	W
SB	Transformer Power	W
er	Resistive part	VA
Uk	Short Circuit Impedance	%

Example

Let us assume that a three-phase transformer, 630 kVA, 20/0.4 kV, has 9300 W load losses and 6% short-circuit impedance. Determine the voltage drop at full load (case 1) and at 75% load (case 2) for power factor 1.0 and 0.8.

The voltage drop is given by the following equation:

- Full load $\cos \varphi = 1$

$$U_{drop} = (1.0) \times (1.4762 \times 1 + 5.816 \times 0) + \frac{1}{2} \times \frac{1}{100} \times (1.0)^2 (1.4762 \times 0 + 5.816 \times 1)^2$$

$$= 1.645 \%$$
- Full load $\cos \varphi = 0.8$

$$U_{drop} = (1.0) \times (1.4762 \times 0.8 + 5.816 \times 0.6) + \frac{1}{2} \times \frac{1}{100} \times (1.0)^2 (1.4762 \times 0.6 + 5.816 \times 0.8)^2$$

$$= 4.832 \%$$
- Load 0.75 & $\cos \varphi = 1$

$$U_{drop} = (0.75) \times (1.476 \times 1 + 5.816 \times 0) + \frac{1}{2} \times \frac{1}{100} \times (0.75)^2 (1.476 \times 0 + 5.816 \times 1)^2$$

$$= 1.202 \%$$
- Load 0.75 & $\cos \varphi = 0.8$

$$U_{drop} = (0.75) \times (1.476 \times 0.8 + 5.816 \times 0.6) + \frac{1}{2} \times \frac{1}{100} \times (0.75)^2 (1.476 \times 0.6 + 5.816 \times 0.8)^2$$

$$= 3.595 \%$$

3.7.1.5 Preferred Transformers for SSE applications

Dry-Type transformers represent the preferred and widest adopted solution in SSE HV/MV/LV applications:

- Low fire load due to design with little insulating material (less than 10 % of the weight is accounted for by the insulants),
- No special fire protection measures required (cast-resin moulding material is fire-retardant and self-extinguishing once the energy supply has been cut off),
- No risks that would make a fire more serious (e.g. toxicity risk due to release of poisonous gases in case of a fire),
- Measures to protect the ground water (e.g. oil collecting troughs or traps) are not required,
- Continuous overload capacity up to 120-130 % of the rated power due to built-on, temperature-dependently controlled radial-flow fans,
- Utilization of the continuous overload capacity as “hot standby“ redundancy to increase the supply reliability,
- No loss of service life when continuous overload capacity is used,

3.7.2 Safety measures when working on transformers

- Work on a transformer is only permitted in voltage-free and earthed condition.
- Transformer windings can be normally insulated on the outer surface by means of an epoxy resin layer. This insulation does not, make them shockproof in terms of the valid standards
- Every transformer radiates a magnetic field when in operation.
- The magnetic field is not significantly reduced by a housing.
- Any person with a cardiac pacemaker or metal implants should avoid the area within a radius of 3 meters.
- Housing or housing parts must not be disassembled during operation.
- Verify that any conductor is de energized before testing for continuity or resistance
- Uncontrolled release of energy may result if the inductors current is suddenly interrupted
- Electromagnets may produce large external forces which may affect the proper operation of the protective instruments and controls.
- By suddenly de-energizing a magnet large eddy currents can be produced in adjacent conductive materials that may cause excessive heating and hazardous voltages.
- A magnetic field can attract nearby magnetic material, including tools, which could cause injury or damage on impact.
- Protection against touch:
 - Transformers supplied as only IP00 must be locked away under use so that when energized they can never be touched. The transformer cast resin surface is not an approved isolator and therefore is not safe to touch.
 - Accidental touch protection should be provided through the installation of safety barriers, gates or similar.

- Earth connections:
 - The total resistance of the protective earthing must be dimensioned in such a way that protective systems are in operation all the time and can act upon an earth-fault.
 - The cross section of the earthing connections must comply with the regulations and on-site conditions and must be maintained at all times also during repair and maintenance operations.
- Electrical and mechanical connections:
 - The minimum distance (according to the rules) between live parts and between live parts and earth must never be diminished.
 - This relates to the distances between cables and high voltage windings in particular
 - All retaining elements of the screw connections are to be checked and replaced if necessary, before reconnecting
 - All connections must fit tightly and be mechanically secure. The bolts for the electrical connections are to be tightened using a torque wrench.

3.7.3 Relevant standards for transformers

In the box, some standards relevant for transformers are listed.

- A. ISO/IEEE80005-1 - Utility connections in port — Part 1: High voltage shore connection (HVSC) systems — General requirements
- B. ISO/IEEE80005-3 - Utility connections in port — Part 3: Low voltage shore connection (LVSC) systems — General requirements
- C. IEC 60034 series (only for RFC) - Rotating electrical machines
- D. IEC 62477-1:2012 - Safety requirements for power electronic converter systems and
- E. IEC 60076-1:2011 - Power transformers - Part 1: General
- F. IEC 60076-3:2013+AMD1:2018 CSV - Power transformers - Part 3: Insulation levels, dielectric tests and external clearances in air
- G. IEC 60076-14:2013 - Power transformers - Part 14: Liquid-immersed power transformers using high-temperature insulation materials
- H. IEC TS 60076-20:2017 - Power transformers - Part 20: Energy efficiency

3.8 Inverters/rectifiers

Inverters and Rectifiers are included here under the same section for their role in modulating AC/DC electricity. Whilst a Rectifier transforms AC into DC electricity, the Inverter

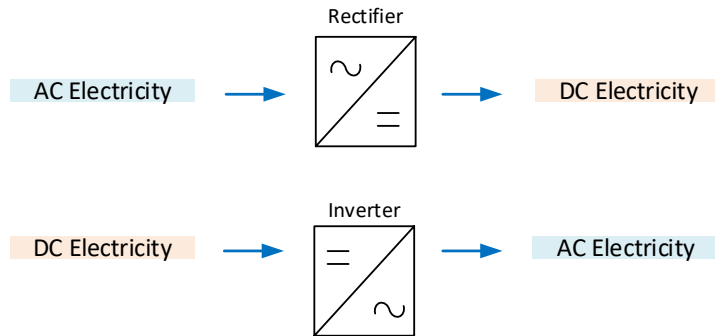

Figure 3.77 - Transformer – Simplified diagram – representation of transformer main elements.

Source: EMSA

A power inverter, or inverter, is a power electronic element that changes direct current (DC) to alternating current (AC). The resulting AC frequency obtained depends on the particular device employed. Inverters do the opposite of “converters” which were originally large electromechanical devices converting AC to DC.[2]

The input voltage, output voltage and frequency, and overall power handling depend on the design of the specific device or circuitry. The inverter does not produce any power; the power is provided by the DC source.

Applications of rectifiers in SSE may be associated to frequency conversion, charging of batteries at any point along the infrastructure or even onboard. In power banking solutions rectifiers will be used to transform AC power supply into DC-charging voltage for the battery groups. The table below highlights different examples of the application of inverter and rectifier units.

Table 3.17 – Example circuits with application of inverter and rectifier units.

Circuit (simplified diagram)	Short description
	<p>Frequency Conversion</p> <p>Rectifier and Inverter Functions are fundamental aspects of a Static Frequency Conversion (SFC) unit.</p> <p>AC power is rectified on the grid line side, frequency changed in the solid-state and DC inverted back into AC for supply of electricity at a desired voltage and new frequency.</p> <p>(See section 3.9 for more on SFC)</p>

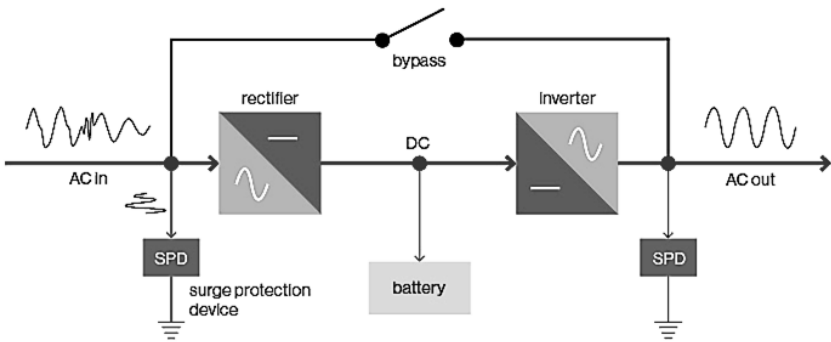
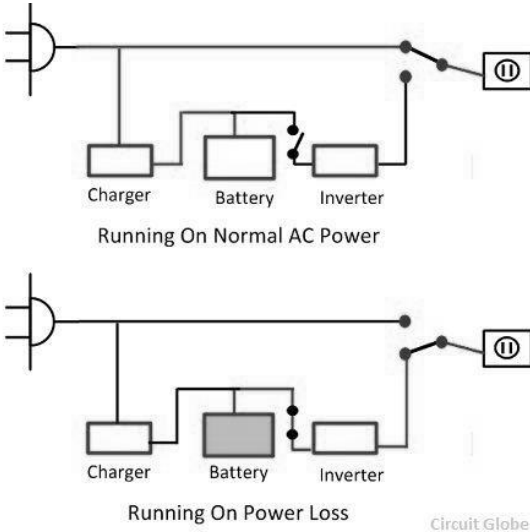
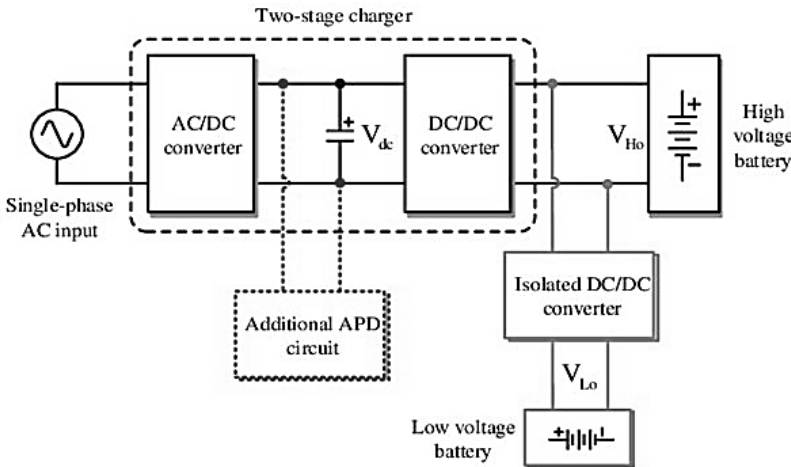
 <p>The diagram shows a typical simplified UPS architecture. AC input (ACIn) enters from the left, passing through a surge protection device (SPD). It then goes to a rectifier block. The output of the rectifier is a DC link containing a battery. From the DC link, the power goes to an inverter block, which outputs AC (ACout). A bypass switch is located between the rectifier and the inverter. Another SPD is located after the inverter before the AC output.</p>	<p>UPS</p> <p>Typical simplified UPS diagram where rectifier and inverter operate together within the same functional device.</p> <p>3 modes are possible</p> <ol style="list-style-type: none"> 1. By-pass 2. AC wave correction 3. Battery supply to grid
 <p>The top diagram, 'Running On Normal AC Power', shows AC input connected to a charger and an inverter. A switch is in the AC line, and a battery is connected to the inverter. The bottom diagram, 'Running On Power Loss', shows the AC input disconnected and the battery connected to the inverter. A small 'Circuit Globe' logo is at the bottom right.</p>	<p>Emergency power</p> <p>Similar to UPS operation, for several different types of critical power usage.</p> <p>This can be the case with OPS if considered to be a critical service supply.</p> <p>Battery capacity can be put to service upon power loss supporting uninterrupted OPS supply.</p> <p>The "charger" is a circuit combination of a transformer, rectifier and, likely, a DC-DC converter.</p>
 <p>The diagram shows a two-stage charging process. It starts with a 'Single-phase AC input' connected to an 'AC/DC converter'. The output of the AC/DC converter is a DC link with voltage V_{dc}. This DC link is connected to a 'DC/DC converter'. An 'Additional SPD circuit' is connected to the DC link. The output of the DC/DC converter is connected to a 'High voltage battery' with voltage V_{Ho}. Below this, an 'Isolated DC/DC converter' is connected to a 'Low voltage battery' with voltage V_{Lo}.</p>	<p>Battery Charging</p> <p>Similar to UPS operation, for several different types of critical power usage.</p> <p>This can be the case with OPS if considered to be a critical service supply.</p> <p>Battery capacity can be put to service upon power loss supporting uninterrupted OPS supply.</p>

3.9 Frequency conversion

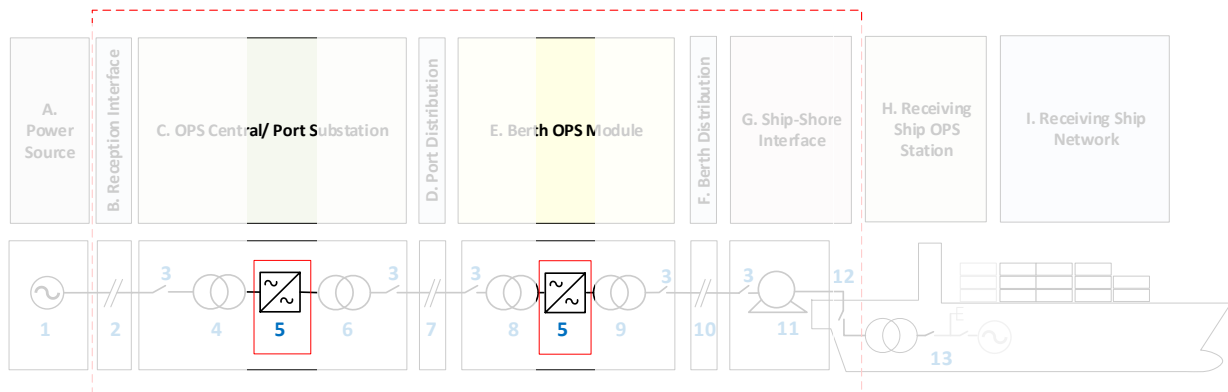

Figure 3.78 - Possible locations for Frequency Conversion – Central OPS substation and Berth OPS Module – Frequency Conversion indicated with #5 in the diagram.

This section provides an overview of Frequency Conversion (FC) as one of the most important functions and infrastructure elements in SSE installations. Since FC represents, in the majority of the cases, the largest investment of an SSE project, the present section dedicates a special focus on the most common features of this equipment so as to provide an overview of the main up-to-date technological aspects

3.9.1 Introduction

A frequency changer or frequency converter is an electronic or electromechanical device that converts alternating current (AC) of one frequency to alternating current of another frequency. The device may also change the voltage, but if it does, that is incidental to its principal purpose, since voltage conversion of alternating current is much easier to achieve than frequency conversion.

Traditionally, these devices were electromechanical machines called a motor-generator set. Also devices with mercury arc rectifiers or vacuum tubes were in use. With the advent of solid-state electronics, it has become possible to build completely electronic frequency changers. These devices usually consist of a rectifier stage (producing direct current) which is then inverted to produce AC of the desired frequency. The inverter may use thyristors, IGCTs or IGBTs. If voltage conversion is desired, a transformer will usually be included in either the ac input or output circuitry and this transformer may also provide galvanic isolation between the input and output ac circuits. A battery may also be added to the DC circuitry to improve the converter's ride-through of brief outages in the input power.

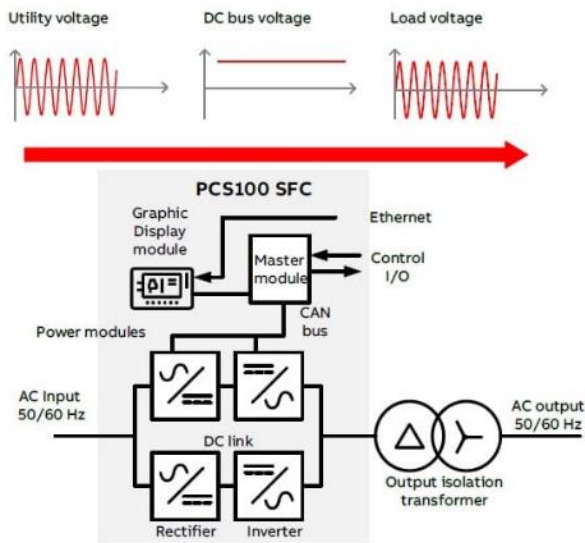

Figure 3.79 - Frequency Conversion Block diagram – Utility voltage step-down not represented.

Source: ABB

3.9.1.1 The need for frequency conversion

The map in the figure below shows the global distribution of AC electrical supply frequencies. Supply of electricity to ships shall have into account the need to convert the frequency by means of a Frequency Converter to be designed in accordance with the expected maximum power supply to ships. Frequency Converters may be static (Static Frequency Converter - SFC), making use of modern solid-state electronics, or rotating.

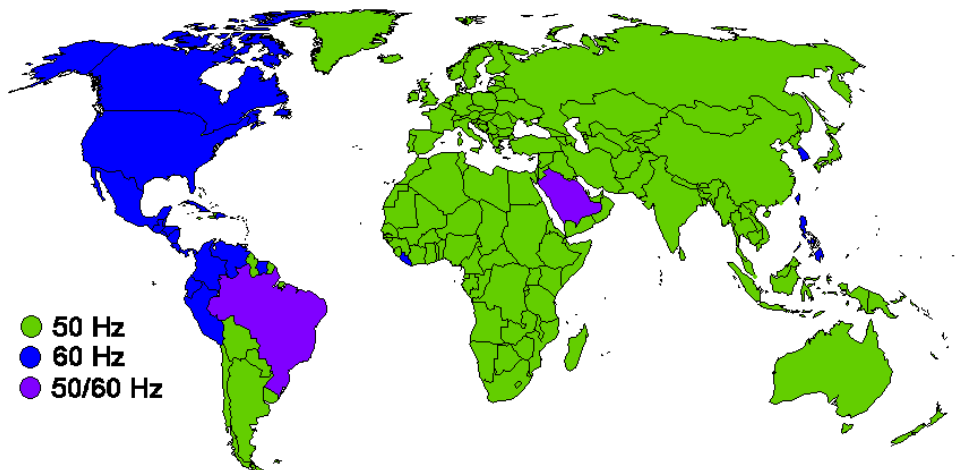





Figure 3.80 - World map distribution of AC utility electricity frequencies.

As it can be seen from the map in Figure 3.80, above, the electricity frequency produced by the grid across the EU may not be compatible with the electricity required by ships. Electricity supply in Europe has a frequency of 50 Hz, however electricity frequency used aboard ships can be either 50 or 60 Hz. A ship designed for 60 Hz electricity may be able to use 50 Hz electricity for some equipment, such as domestic lighting and heating. However, it could not use 50 Hz for the operation of motor driven equipment such as pumps, winches, and cranes. Electricity at 50 Hz would make these motors run at about 83% of their design speed, which is likely to have damaging effects on the equipment. Therefore, a ship using 60 Hz electricity will require 50 Hz electricity to be converted to 60 Hz by an electricity converter.

Ships produce, in their vast majority, 60 Hz electricity, being equipped at ship grid-level with equipment which is prepared to operate on that specific frequency. The table below indicates the possibility for some ships which may use 50 Hz. This would be mostly on cases of domestic operation where all ports called (e.g., in Europe) are equipped with 50 Hz supply.

Table 3.18 - Applications and segments overview of frequency conversion for shore-to-ship power [16].

Characteristics	Vessel Type			
	RORO/Ferry	Container	Cruise	LNG / Tanker FSU / FPSO
				
Voltage	11 kV or low voltage	6,6 kV	6,6 & 11 kV	6,6 kV
Max Power consumption	6,5 MVA	7,5 MVA	16/20 MVA	Approx. 10 MVA
Frequency	60 & 50 Hz	60 mainly	60 mainly	60 Hz
Plugs/cables (per connection)	1	2	4+1	2/3
Transformer	onboard	onshore	onshore	onshore
Layout	Not critical	critical	critical	critical
Load profile	Partially controlled	Partially controlled	Flat profile	Not controlled

3.9.1.2 Types of Frequency Converters

There are essentially 2 types of Frequency Converters: 1) Rotating and 2) Static, as presented in the figures below.

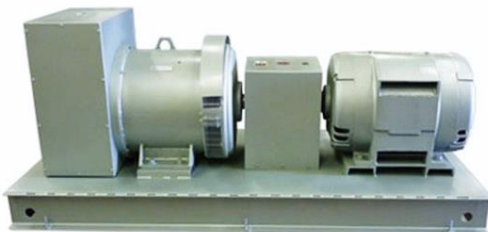

Figure 3.81 – Rotating Frequency Converter (RFC), composed by electric motor and generator units.



Figure 3.82 – Static Frequency Converter (SFC) presented in a modular standard unit [16].

The single-line diagrams for RFC and SFC, respectively, are presented in the figures below:

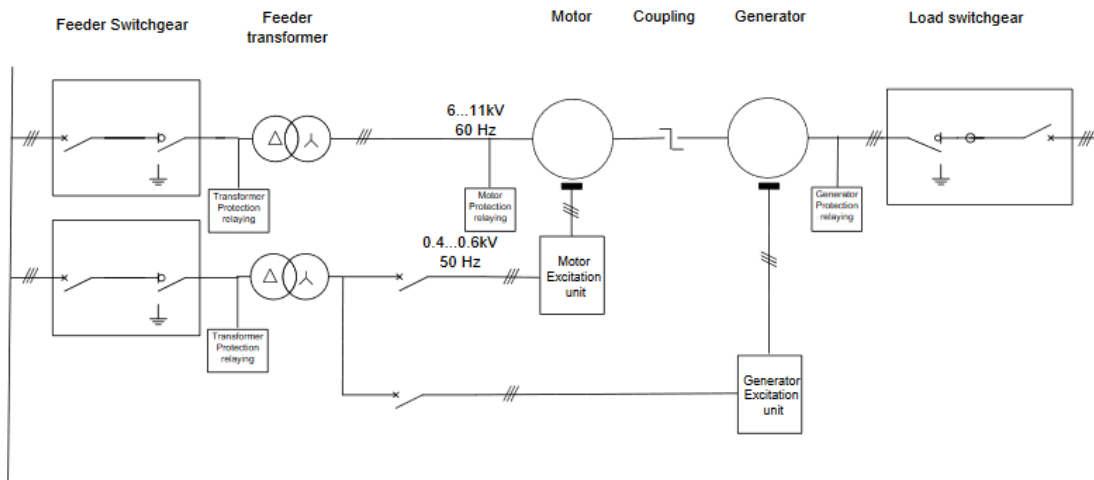

Figure 3.83 – Single Line Diagram – Rotary Frequency Converter.

Source: EMSA

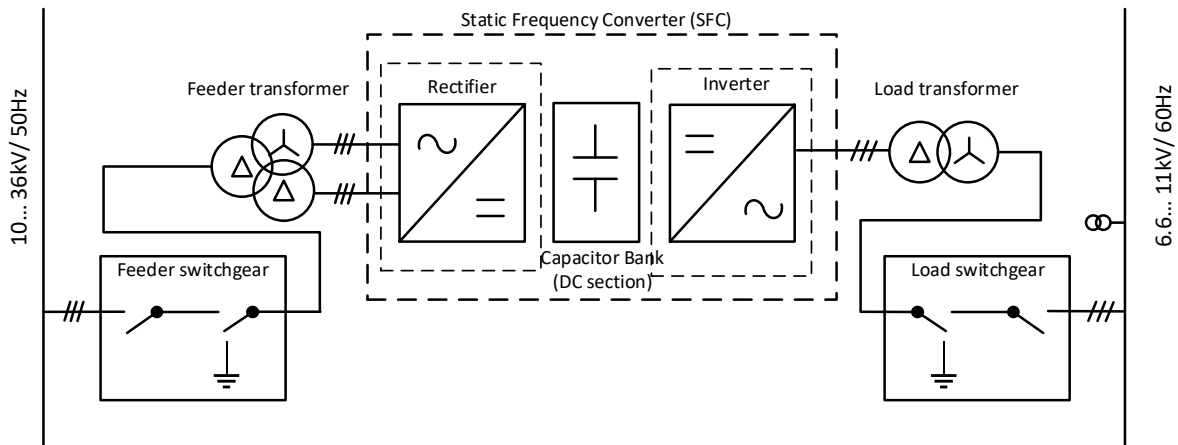

Figure 3.84 - Single Line Diagram – Static Frequency Converter.

Source: EMSA

Rotary frequency converters consist of an electric motor coupled to a generator. The coupling is direct or with belts & sheaves, with a few with a gear box connection. Frequency conversion is achieved by either changing the rotational speed of the generator (in the versions with belts & sheaves) or the gear box. And motors and generators coupled with a different number of poles. The result is operating to achieve the same result of producing the desired output frequency. A rotary frequency converter is also capable of producing a different voltage at the same time.

The rotary frequency converter will provide the rated kVA requirements at the output needed. In addition, a motor and synchronous generator will provide the required frequency and voltage. A precision voltage regulator integrated within the system maintains the output voltage at (+/- .5%) far better than the industry standard.

The three-phase static frequency converter converts the source power. It converts from one voltage and frequency to another voltage and frequency. Solid State technology means the static converter's only moving parts are the fans used for forced cooling of the system. Solid-state converters are built upon a dynamic platform and incorporate the latest technology in solid-state namely Pulse Width Modulation Inverter and Rectifier controls.

Static frequency converters are available in the market for a wide range of power demand applications. They are ideal for applications where footprint, noise, and controls are a priority. With modular configurations they allow for a versatile and flexible architecture, aspects which are of central relevance for applications in SSE systems.

Below, an example of a Static Frequency Converter shows the modular presentation of modern SFC systems.

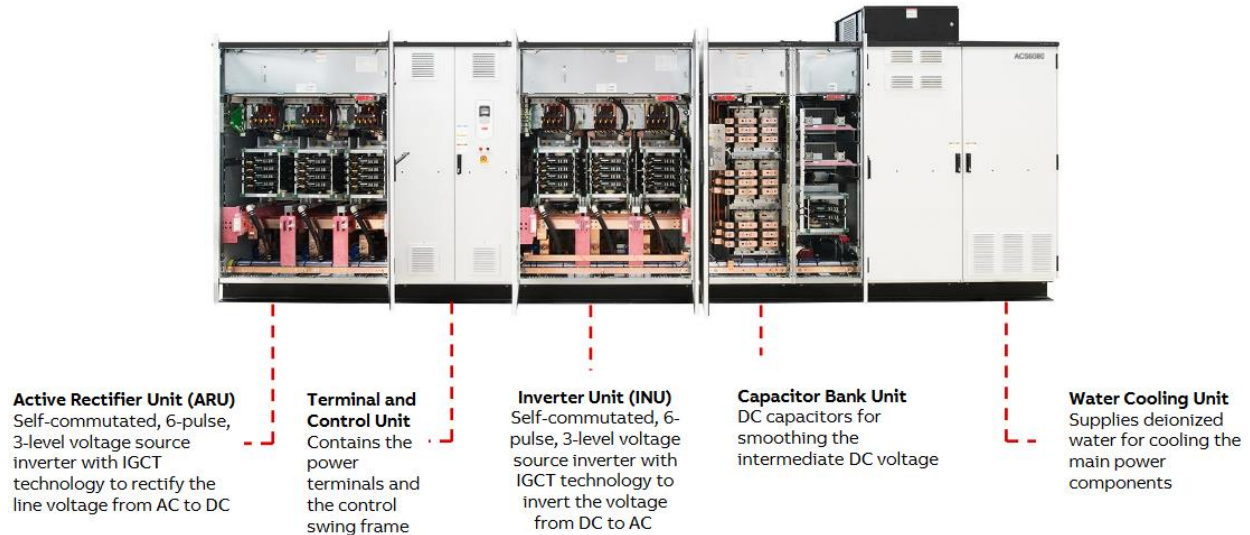







Figure 3.85 – Static Frequency Converter – Example of modular SFC unit [16].

Below, the main components of an SFC are presented, Input and Output transformers are included but may not always be present. SFC has also the ability to act over voltage as well as frequency. It is however important that input voltage from grid or microgeneration match the SFC input rated voltage.

Input Power	Rectifier	Capacitor unit	Inverter	Output transformer
				
Step-down transformer	12/24 pulse diode bridge/ Active rectifier/ IGCT active voltage source converter IGBT voltage source converter/ supply unit	Reactor Inductance	IGCT (Integrated Gate Commutated Thyristor) power switching devices IGBT voltage source converter	
Input Transformer essentially to match grid input voltage with SFC input rated voltage	SFC acts over voltage and frequency, transforming V1, F1 into V2, F2.			Output transformer for isolation

Having presented both rotary and static frequency converters, the following table highlights the main differences between the two:

Table 3.19 – Comparison between rotary and static frequency converters.

Comparative Features of Frequency Converter Units [17]		
Characteristic	Rotary Frequency Converter	Solid State Frequency Converter
Power (Cost/kW, kVA)	> 5 KVA, Less costly per kW (or KVA)	> 5 KVA, more costly per kW (or KVA) (in 1-3 KVA sizes, solid state tends to be less expensive)
	Costs do not increase linearly with power, e.g., 3x power costs 1.5x dollars	Costs are more linear, e.g., 3x power costs 3x dollars (because hardware expansion is linear).
Applicability	More attuned to larger applications 10 KVA plus	More attuned to smaller applications 1-5 KVA
Installation	Rugged floor mount construction	Generally, in equipment racks or rack mountable
	Some installation and setup are required, e.g., concrete pad, power circuits	Some installation and setup may be required, but usually less than rotary alternative
Output Frequency	Generally fixed output frequency	Highly variable output frequency, typically 45-500 Hertz
MTBF¹⁰	MTBF: 20,000 to 32,000 Hrs. (belted) 30,000 to 60,000 Hrs. (single shaft)	MTBF: 10,000 to 20,000 Hrs.
Maintenance	Preventive maintenance is required, e.g., bearing maintenance, belt replacement (except single shaft units), cleaning air intakes and exhausts	Little or no preventive maintenance other than cleaning fans, exhausts
Environmental Footprint	Some environmental objections, e.g., audible noise, unit weight, space factor, etc.	Fewer environmental objections, e.g., generally quieter, lighter weight, etc.
Power Factor	Input to the converter's motor has lagging power factor that increases with load.	Input current has high crest factor that also causes leading power factor that increases with load.
Harmonics	Harmonic distortion and noise on the input power is not passed to the output	Harmonic distortion and noise on the input power is not normally passed to the output, some high frequency noise may be passed to output.
	Output harmonic distortion is moderately low, typically <4 to 5%	Output harmonic distortion is lower, <0.05%,
Output source impedance	Low output	Very low
Overload capability	Can source heavy overload currents 2-4X for short periods of time, depends upon generator windings and momentum of rotating components. Overloads generally cause voltage reduction but not large waveform distortion	Can source overloads for generally shorter periods of time, depends upon capacitive storage in unit. Overloads may cause a sharp rise in distortion.
Efficiency	Full load efficiency 60 to 65% on smallest units (<6.25 KVA) up to 85 to 92% on large units	Full load efficiency 60 to 92 % all sizes Some manufacturers report efficiencies up to 98% [16].
	Efficiency varies with load, better with heavy loads	Efficiency varies with load, better with heavy resistive loads and lower output frequencies

¹⁰ MTBF – Mean Time Between Failure

3.9.1.3 SFC Solid State elements

If a comparison between RFC and SFC allows to identify the main differences between these two FC technologies, it is also important to look closer into SFC technology itself and identify the main differences that might distinguish Solid State FC. These systems are based in power electronics and may include applications of different solid-state elements, such as thyristors and transistors.

When choosing between different SFC products available in the market a closer look into the solid-state technology applied may allow a more and better-informed choice between different available equipment.

To help on this This section compares GTO vs IGCT vs IGBT and mentions difference between GTO, IGCT and IGBT. GTO stands for Gate Turn-Off Thyristor, IGCT stands for Insulated Gate Commutated Thyristor and IGBT stands for Insulated Gate Bipolar Transistor. The comparison between the three devices is derived with respect to symbol, characteristic, advantages, and disadvantages.

The table below presents the main differences between the solid-state elements applied in different SFC equipment.

Table 3.20 – Difference between solid-state elements applied in different SFC equipment.

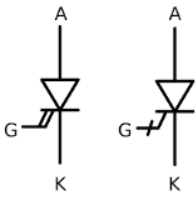
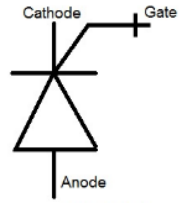
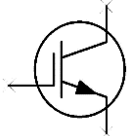
Device	Symbol	Advantages	Disadvantages	Applications
GTO Gate Turn-Off Thyristor		<ul style="list-style-type: none"> Controlled turn-off ability. Relatively high overload capacity. Series connection possibility. Working frequency of hundreds of Hz. 	<ul style="list-style-type: none"> Higher on-state losses. High control power. 	<ul style="list-style-type: none"> High power drives Static compensators Continuous supply sources Induction heating sources
IGCT Insulated Gate Commutated Thyristor		<ul style="list-style-type: none"> Controlled turn-off ability. Relatively high overload capacity. Low on-state losses and voltage drop. Working frequency of kHz. Series connection possibility. High cyclic resistance. 	<ul style="list-style-type: none"> IGCT are made like normal disk devices which has high electro-magnetic emission. IGCT are cooling critical 	<ul style="list-style-type: none"> High power drives Supply inverter sources for DC transmissions Big frequency converters
IGBT Insulated Gate Bipolar Transistor.		<ul style="list-style-type: none"> Controlled turn-off ability. Minimum working frequency up to 10 kHz. Very low control power. IGBT lifetime greater than IGCT 	<ul style="list-style-type: none"> Very high on-state losses. Relatively low cyclic resistance. 	<ul style="list-style-type: none"> Continuous supply sources Static compensators and active filters Switching sources

3.9.2 Input data for frequency converter selection in SSE

The typical input data to select a Frequency Converter are:

- Utility Voltage (V) and Utility Frequency (Hz)
- Load Capacity (kVA) and kW or kVA and pf
- Load Frequency
- Ambient operating data
- IP rating requirements

In addition, important design requirements, case-specific may also be defined:

- Data Communication and Control requirements
- Redundancy and Replaceability – Equipment part redundancy VS System redundancy
- Parallel Operation requirements (requiring technical barriers to overloading when a single unit fails) – Requirement for Load Side Circuit breaker.
- Ability for Synchronisation.
- Power Management

In addition to the standard initial input data above described, it is also important that a choice is made regarding the transforming units that may have to be considered:

- Incoming transformer (step-down), to adjust port distribution or grid incoming distribution voltage.
- Output transformer, which will not only provide voltage matching and isolation of the common mode voltages generated by the converter but also very importantly galvanic isolation for the ship from the shore earth¹¹. The isolation is required to eliminate earth currents that cause galvanic corrosion between the ship's hull and other metal objects.

3.9.3 Control features

Representing such important elements of an SSE/OPS infrastructure, Frequency Converters are best exploited when equipped with control features that allow control and integration. The following are important control features of Frequency Converters, specifically of Static Frequency Converters:

Power Module Redundancy

A possible reliability feature of modular SFC designs is the ability to incorporate built-in redundancy capability as an intrinsic feature of the modular system design. Upon a fault of a single rectifier or inverter, the control unit may reduce the output capacity of the SFC to the available remaining working rectifier/inverter module pairs.

This reduction of capacity may represent a minor impact, as typically the converter is not running at full load. The load is, in this case, transferred to the remaining module pairs in the converter. The maximum output of the converter will inevitably be reduced but only by a fraction of the entire rated power output of the whole converter unit.

For redundancy to be ensured seamlessly, without notice to the load in operation, it is important that modular systems are equipped with adequate control units and power management units.

When opting between different FC options, modular redundancy, within the same FC equipment, will allow for whole SSE system reliability without having to install parallel FC for the purpose of redundancy. Paralleling FCs may still be opted, in addition, provided that a power management unit ensures adequate

¹¹ When a converter is installed on board to provide power conversion from the shore supply, a transformer must be provisioned on the input side of the frequency converter. The transformer will not only provide voltage matching and isolation of the common mode voltages generated by the converter but also very importantly galvanic isolation from the shore earth. Galvanic isolation from the shore earth is required to eliminate the earth currents that cause galvanic corrosion between the ship's hull and other metal objects

parallel operation during failure adjustment of one unit. To be noted that the failure of one inverter/rectifier pair will affect to some extent the power of the SFC but will not affect its output voltage.

Figure 3.86 shows an advanced modular redundancy concept by ABB [18].

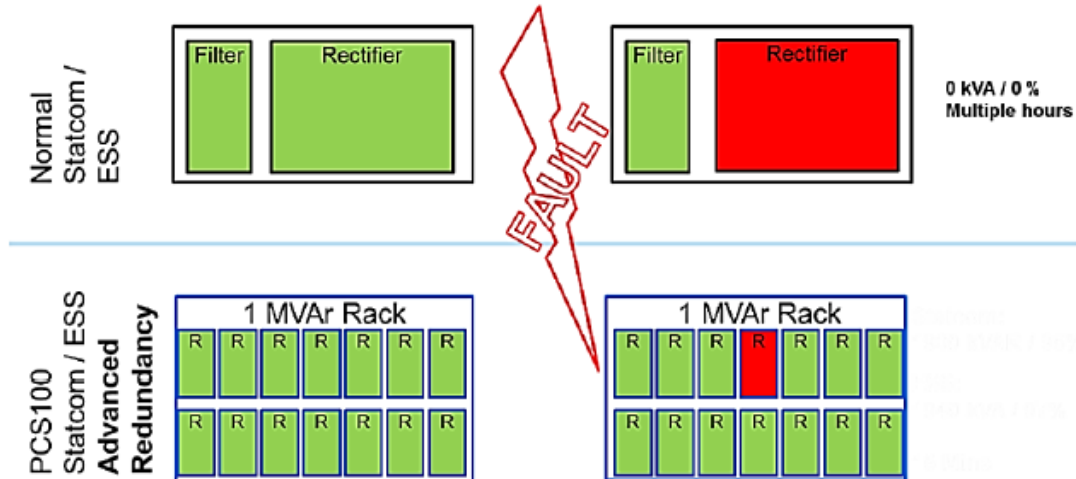

Figure 3.86 – Static Frequency Converter – modular redundancy.

Source: ABB

Parallel load sharing

SFCs may be used in parallel with other voltage sources, either other generators or multiple SFC units. Parallel load sharing is achieved using frequency and voltage droop¹² profiles programmed into the converter. This may allow the converters to share power with other systems without the need for any additional communication signals. In addition, SFC converters of different power ratings can be paralleled, with each one delivering the same percentage of its rated power as required by the load.

Power Flow control

Using advanced power flow control capabilities in an SFC provides the ability to control the power flow from one AC grid to another AC grid. This feature is especially useful for interfacing different grid levels in the context of microgrids and smart grid layouts, where SFC may be subject to bidirectional power flows. Both real and reactive power flow can be controlled in either direction using a variety of control interfaces. This is today not a customary feature of OPS SFCs installed ashore, but this may well develop as the introduction of microgrid and smart grid.

Automatic Output Synchronisation

Where two or more SFC units are paralleled together, or the SFC is connected to an AC bus with other generators, starting the SFC into the live bus is greatly simplified in presence of an automatic output synchronisation feature. If the output of the SFC is live, then its controller will first match the phase voltage and frequency to the AC profile output and only then enable the inverter modules. This enables a seamless transfer from generator supply to SFC supply on the output bus. This is particularly relevant for SSE grids where microgeneration by port generators is used in parallel with the grid.

Remote Synchronisation

In addition to the automatic output synchronisation feature, a SFC also has a dedicated voltage sensing input to allow the converter to synchronise its output to any other three phase voltage reference. This feature is particularly useful where two separate busses must be synchronised before connecting them together i.e. closing a bus tie breaker on a vessel switchboard.

¹² Voltage droop is the intentional loss in output voltage from a device as it drives a load. Adding droop in a voltage regulation circuit increases the headroom for load transients. All electrical systems have some amount of resistance between the regulator output and the load.

Output Short Circuit Protection

Should a short circuit occur on the SFC output the converter may automatically provide current limiting of a larger nominal current for a short-defined period of time seconds. This allows discrimination with downstream protection. If the fault is still present after 2 seconds the SFC will trip offline to avoid damage.

3.9.4 Safety aspects and faults in frequency converters

The main Safety Challenges associated to Frequency Converters depend on:

- 1) the type of FC technology,
- 2) the installation location,
- 3) the input line and, finally,
- 4) output load.

These contribute to the operation of Frequency Converters in different ways:

1. **Type of FC technology:** There are technology-specific aspects which need to be considered. This is, e.g. the case when considering rotating VS static frequency converters. Whilst one may represent potential mechanical hazard, the other is primarily an electrical/power-electronics equipment with more electrical safety related concerns.

Also, when looking at different solid-state components there are different characteristics of diodes, transistors or thyristors which may have a direct relation with the safety profile of the equipment. This is, for instance, the case with IGCT which heat management is critical with the likely need for liquid cooling arrangement in higher power applications.

2. **Installation location:** The place of installation destined for the SFC will dictate the level of protection of the casing/enclosure (Typically IP52¹³). Exposure to water, spray, salts, dust/grain/debris, may dictate the level of protection to be considered. Protection should not hamper the functional role of cooling/ventilation. Port-specific and terminal-specific aspects should be taken into consideration.
3. **Input line:** Power Quality in the source is an important conditioning factor affecting FC performance. Suitable filtering and power conditioning unit should be provided. Transformer in the input side may help to ensure power quality.
4. **Output load:** The operating profile of the load affects the Frequency Converter if load variation is significant or if the FC is operating in parallel to meet load demand.

¹³As per (IEC) 60529 – IP52 - Enclosures constructed (without knockouts) for indoor use; to provide a degree of protection to personnel against incidental contact with the enclosed equipment; to provide a degree of protection against falling dirt; against circulating dust, lint, fibres and flyings: and to provide a degree of protection to against dripping and light splashing of liquids

Table 3.21 – Safety concerns associated with frequency converters.

Safety Concerns	Short description	Mainly Applicable to	
		RFC	SFC
Occupational Risks - Mechanical	RFCs have rotating mechanical gear which must be protected by adequate IP rating against entanglement/trapping. Rotating parts may be shafts, belts, or gearboxes.	X	
Misalignment, Vibrations	Due to unforeseen circumstances, rotating parts, otherwise aligned in normal operation, may misalign leading to vibration and fast degradation of bearings on the motor and generator sides	X	
Occupational Risks - Electrical	High Voltage, current, charged capacitors represent hazards which should be kept away from access during normal operation. Access to areas where live/hot conductors and equipment may be operating will represent critical electrical safety risk to operators.		X
Electromagnetic risk	Typically, high electromagnetic emissions are associated to the operation of power electronics in SFC. Shielded casings and		X
Arcing/Fire Safety	Where high-voltage switching gear is included, or where live uninsulated conductors or busbars are installed, it is important to ensure that adequate arcing protection devices are also provided.		X
Overcurrent fault	A sudden increase in current can take place due to load variations, either operational or emergency. Loose connections or broken conductors may also be associated to malfunction conditions when overcurrent and control problems occur. Loose power connections cause overvoltage and overcurrent conditions, blown fuses, and frequency converter damage. Loose control wiring causes erratic frequency inverter performance, resulting in inability to control the frequency converter.	X	X
Erratic operation	If and when the frequency converter is functioning erratically, but a fault is not indicated, external factors may be the cause, or the frequency inverter itself may have failed. Understanding the causes of frequency converter faults helps you determine the root cause of the problem. Frequently overlooked root causes are usually instabilities in the process that force the frequency converter to function in harsh conditions. <u>Power quality is another electrical issue that can affect a frequency converter.</u> A change in utility equipment or unexpected power surges, due to electrical storms or system overloads, can affect frequency converter performance.		X

<p>Contamination failure</p>	<p>Contamination is a preventable cause of frequency converter failure.</p> <p>Failure, following contamination, may have catastrophic proportions or even force the replacement of significant parts of the FC.</p> <p>A periodic maintenance program for FCs should include:</p> <ul style="list-style-type: none"> • Regular check for contamination of dust, moisture, or other airborne particles that may be electrically conductive. • Tracking or arcing marks across components or circuit board traces indicate evidence of contamination failures. • internal cooling fans and component heatsinks of the frequency converter should also be regularly checked for contamination • Check the fan for grease/oily traces and other contaminants that can cause bearings and other parts of the fan to fail. • interior and exterior of the frequency converter, including fans, blowers, filters, and heatsink fins, should be cleaned monthly to reduce the risk of failure from contaminants. 		X
<p>Temperature failure</p>	<p>The environment within which the frequency inverter must operate must be within specified temperature limits. Temperature, outside and inside the FC enclosure should be within the ambient specifications determined by the manufacturer. Failure to meet the required temperature specifications can lead to premature frequency converter failure because numerous power components rely on adequate cooling for proper operation.</p> <p>If the ambient temperature is too high, additional cooling should be added to the enclosure or the frequency converter should be relocated to an area where the ambient temperature is within the specification.</p> <p>Low ambient temperatures may cause problems as well. Condensation may form and cause component or frequency converter failure.</p>		X

3.9.5 Requirements for frequency converters in IEC/IEEE80005

Both IEC/IEEE 80005-1 and 3, for HVSC and LVSC, respectively, both in Part 2, Section 4.3, list relevant requirements for shore connection converter equipment.

The main areas covered in IEC/IEEE80005 are presented below, divided into the main groups:

<p>General</p>	<ul style="list-style-type: none"> • Where provided, converting equipment (transformers, rotating frequency converters and/or semiconductor converters) for connecting HV shore supplies to a ship electrical distribution system shall comply and be constructed in accordance with the different standards listed in the table of section 3.9.7. • The effect of harmonic distortion and power factor shall be considered in the assignment of a required power rating. • Transformer winding and semiconductor or rotating converter temperatures shall be monitored, and an alarm shall be activated to warn relevant duty personnel if the temperature exceeds a predetermined safe value.
<p>Selectivity</p>	<ul style="list-style-type: none"> • The use of frequency converters shall not compromise the electrical protection selectivity of the largest on-board load while connected. Compatibility in Selectivity shall be ensured for operation to ensure load side trips • Where additional selectivity (e.g., with transformer) is required and cannot be achieved, other measures may be agreed between ship and shore giving due regard to a) to g) of 4.3. All selectivity aspects should be clearly addressed as part of the compatibility assessment file. <p>NOTE: Other measures can include, among other things, switching of protection setting, other protection schemes other than over-current and short circuit.</p>
<p>Degree of Protection</p>	<ul style="list-style-type: none"> • The protection for electrical equipment shall be in accordance with <ul style="list-style-type: none"> - HVSC: IEC 61936-1 - LVSC: IEC 60529 • The following aspects should be considered when determining the electrical protection: <ul style="list-style-type: none"> - Fundamental requirements related to the specific aspects of the installation, including mechanical and electrical requirements - Location, indoors/outdoors, including proximity to other infrastructure elements - Insulation, Earthing, Clearances - Equipment specific requirements with particular focus on Frequency Conversion, Transformers, Capacitors and Rotating Equipment (applicable for RFC) - Safety measures <ul style="list-style-type: none"> ▪ Protection against direct contact ▪ Means to protect persons in case of indirect contact ▪ Means to protect persons working on electrical installations ▪ Protection from danger resulting from arc fault (specifically for HV) ▪ Protection against direct lightning strokes ▪ Protection against fire ▪ Protection against leakage of insulating liquid and SF6 - Protection, control and auxiliary systems <ul style="list-style-type: none"> ▪ Monitoring and control systems ▪ DC and AC supply circuits ▪ Basic rules for electromagnetic compatibility of control systems - Earthing system • Specific requirement for Protection against overload is also presented in IEC/IEEE 80005-1/2: An alarm is to be activated to warn relevant duty personnel. The alarm shall be activated at a lower overload level than that of the circuit-breaker protection. Alarms from the onshore protection equipment shall be transmitted to the ship using the data communication link, if such data communication link is installed.

Cooling

- Where forced or closed-circuit cooling is used, whether by air or with liquid, an alarm shall be initiated when the cooling medium exceeds a predetermined temperature and/or flow limits.
- Semiconductor frequency convertor equipment shall be so arranged that it cannot remain loaded unless effective cooling is maintained. Alternatively, the load may be automatically reduced to a level compatible with the cooling available.
- Liquid-cooled frequency convertor equipment shall be provided with leakage alarms. A suitable means shall be provided to contain any liquid which may leak from the cooling system so that it does not cause an electrical failure of the equipment.
- Where liquid-cooled heat exchangers are used in transformer cooling circuits, there shall be detection of leakage, and the cooling system shall be arranged so that the entry of cooling liquid into the transformer is prevented.
- Where the semiconductors and other current carrying parts of semiconductor convertors are in direct contact with the cooling liquid, the liquid shall be monitored for satisfactory conductivity, and an alarm shall be initiated if the conductivity is outside the manufacturer's limits.
- The alarms shall be activated to warn relevant duty personnel, on both shore and ship-sides

3.9.6 Installation configurations

The present section highlights the different possibilities which may be available to the outline configuration/ topology, based on different number, location, and configurations of Frequency Conversion equipment.

Location, number, and arrangement of Frequency Conversion is not only one of the most important design decision-making, but also one of the decisions with greatest cost and operational impact.

With Frequency Converters being rather expensive equipment, design of SSE installations should assess the best cost-effective, and operating-effective, configuration layout for installation of Frequency Conversion capability.

Concentrating all power in one Frequency Conversion Equipment is, in general terms, and particularly for high power applications, not a good idea. Redundancy in FC equipment is an important aspect to ensure, with the redundancy typically deriving from breaking down the required FC installed power into smaller FC units. Internal FC modular redundancy is also able to provide the redundancy necessary but comes with the cost of power capacity reduction in the event of failure.

The following strategies can be used for SSE grid design:

- A. No Frequency Conversion
- B. Centralized Frequency Conversion (One FC in Port/Terminal Level location)
- C. De-Centralized Frequency Conversion (One FC in Berth Level location)
- D. Multiple Centralized Frequency Conversion (Multiple FC in Port/Terminal Level location)
- E. Multiple De-Centralized Frequency Conversion (Multiple FC in Berth Level location)
- F. DC SSE grid distribution, with the rectifier and inverter units distributed along the SSE grid.

As an example, below, an arrangement of 3 x 1.4MVA FC highlights how FC equipment in line redundancy can look (case D or E above, with multiple FC equipment). Giving preference to more smaller FCs than to only one higher power FC may have implications in cost, with a cost-benefit analysis being an important tool to support decision-making.

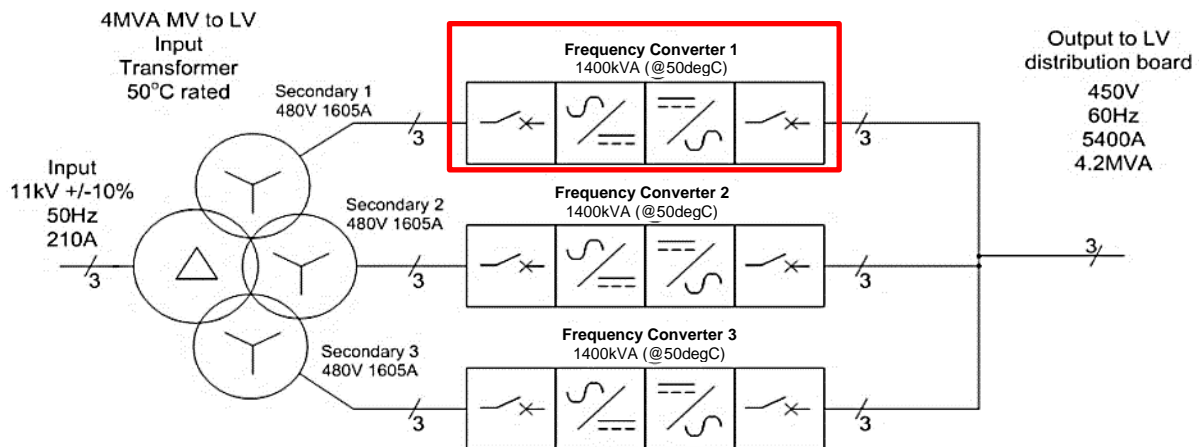

Figure 3.87 – Static Frequency Converter – Parallel installation of SFCs – 3 x 1.4MVA = 4.2MVA – Parallel installation allows for redundancy [16].

More about the SSE grid configurations, based on different numbers and location of conversion equipment can be found in Part 2, Section 4.3.

3.9.7 Relevant standards for frequency converters

In the box, some standards relevant for frequency converters are listed.

- A. ISO/IEEE80005-1 - Utility connections in port — Part 1: High voltage shore connection (HVSC) systems — General requirements
- B. ISO/IEEE80005-3 - Utility connections in port — Part 3: Low voltage shore connection (LVSC) systems — General requirements
- C. IEC 60034 series (only for RFC) - Rotating electrical machines
- D. IEC 62477-1:2012 - Safety requirements for power electronic converter systems and equipment - Part 1: General
- E. IEC 60146-2:1999 - Semiconductor converters - Part 2: Self-commutated semiconductor converters including direct DC converters
- F. IEC 61800-3:2017 - Adjustable speed electrical power drive systems - Part 3: EMC requirements and specific test methods
- G. IEC 60721-1:1990+AMD1:1992+AMD2:1995 CSV - Consolidated version Classification of environmental conditions - Part 1: Environmental parameters and their severities
- H. IEC 61071:2017 - Capacitors for power electronics
- I. IEC 60871-1:2014 - Shunt capacitors for AC power systems having a rated voltage above 1 000 V - Part 1: General
- J. IEC61439 series - Low voltage switchgear and controlgear
- K. IEC62271-1 - High-voltage switchgear and controlgear - Part 1: Common specifications for alternating current switchgear and controlgear
- L. IEC60071-1 - IEC 60071-1:2019 - Insulation co-ordination - Part 1: Definitions, principles and rules
- M. IEC60664 series - Insulation coordination for equipment within low-voltage supply systems
- N. IEC 60529:1989+AMD1:1999+AMD2:2013 CSV - Degrees of protection provided by enclosures (IP Code)
- O. IEEE519 - Recommended Practice and Requirements for Harmonic Control in Electric Power Systems
- P. IEC61000-2-4:2002 - Electromagnetic compatibility (EMC) - Part 2-4: Environment - Compatibility levels in industrial plants for low-frequency conducted disturbances
- Q. IEC 61558-2-6:2009 - Safety of transformers, reactors, power supply units and similar products for supply voltages up to 1100 V. Part 2-6: Particular requirements and tests for safety isolating transformers and power supply units incorporating safety isolating transformers.
- R. IEC 61000-6-4:2006+AMD1:2010 - Electromagnetic compatibility (EMC). Part 6-4: Generic standards - Emission standard for industrial environments.
- S. IEC 61000-6-2:2016 - Electromagnetic compatibility (EMC). Part 6-2: Generic standards - Immunity for industrial environments.
- T. IEC 60076 Power Transformers (All parts) – NOTE: applicable to all transformers, when incorporated into the Frequency Converter system.
- U. IEEE1662-2016 - IEEE Recommended Practice for the Design and Application of Power Electronics in Electrical Power Systems (for additional recommendations on testing HV power electronics)

3.10 Energy storage systems

Energy Storage, in particular Electrical Energy Storage (EES), is an important element of modern power grids of different scales. Ensuring the possibility to store energy, decoupling Supply and Demand and allowing for the introduction of renewable energy sources, provides for flexibility in microgeneration at port level. This is however only one of the advantages that can be provided by energy storage. Power Quality, Energy Efficiency and Security or grid resilience are amongst the wider range of aspects which are generally favoured by the introduction of energy storage elements.

The present Guidance document is specifically focused at EES technologies considered to be best suitable for port grid scale applications, with storage capacities ranging few hundreds of kW up to 10MW.

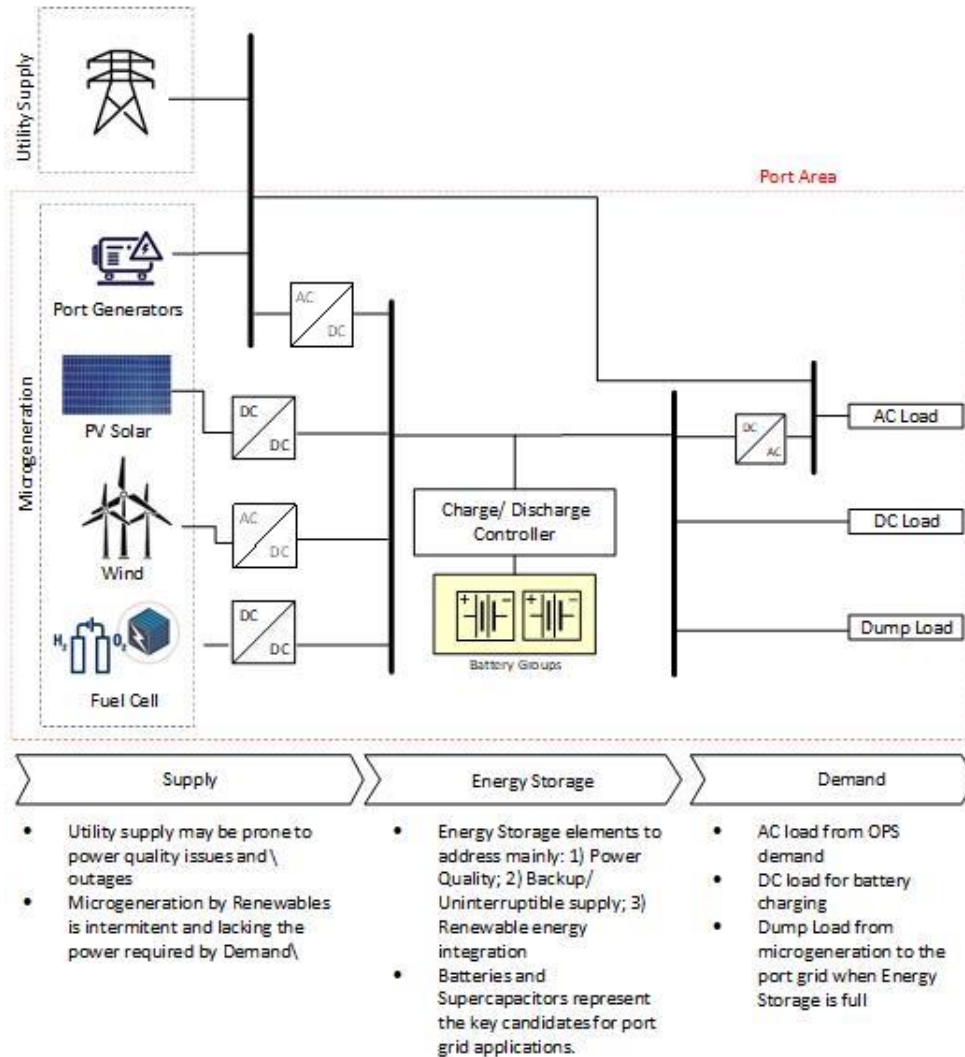

Figure 3.88 - Electrical Energy Storage for Ports

Note: Battery Groups represented for illustration as a EES option. Electrical Energy Storage roles for Ports should primarily be: 1) Power Quality; 2) Backup Supply and 3) Renewable Energy Integration

Source: EMSA

The debate and development of EES is currently associated to the increasing needs for grid resilience, incorporation of renewable energy sources and to the development of Smart Grid solutions. This is however mostly focused on Utility Grid applications. Port Grid level applications have however similar opportunities for deployment of EES systems, especially if associated to a wider effort on electrification, with multiple Port services using the advantages provided by a robust port electrical grid. SSE services and cargo handling are amongst the group of port services with the highest potential to benefit from EES. It should be furthermore acknowledged that ports represent a complex environment where opportunities for automation and multi-terminal integration are currently being explored towards increasingly energy efficient infrastructures, services, and operations. Even acknowledging the obvious fact that ports are all

very different in size and complexity, it is important to note that there are at least one or two important opportunities for EES systems.

The diagram in the figure below presents different opportunities for EES specifically identified at port grid level, in comparison to the utility and ship grids, respectively of larger and smaller sizes, representing also different power levels and functional requirements. The present Guidance focuses strictly on the port grid and, simultaneously, with its interactions as a “customer” of the utility and “supplier” of the ship in a context of SSE services.

Figure 3.89 - Energy storage at different grid levels.

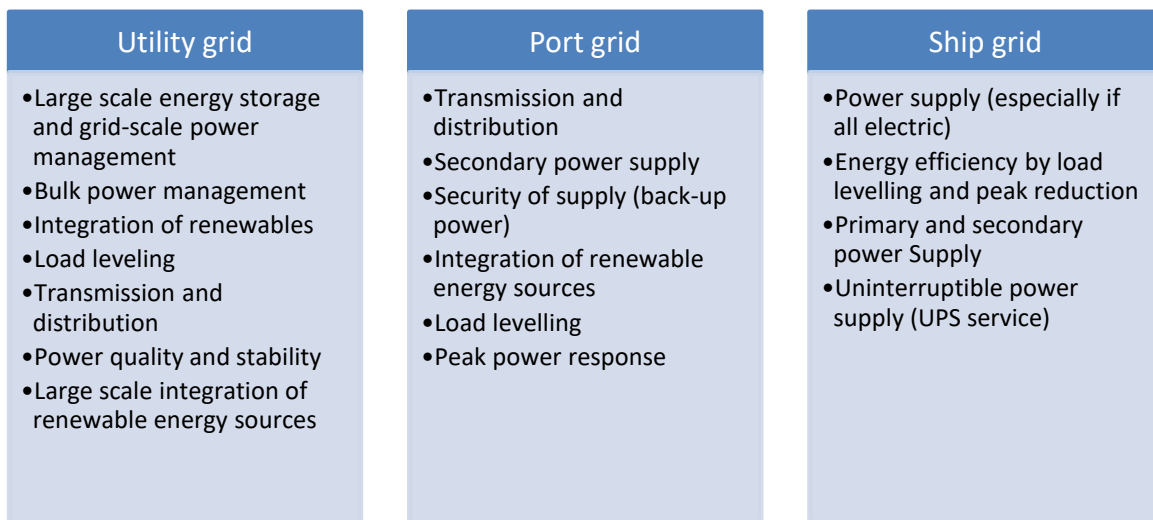

When looking to the possible applications of EES, PAA should consider, in particular, the benefits for safety, security and sustainability that can be immediately derived from the introduction of backup power support, grid resilience and renewable sources integration, respectively.

An example of clear role of EES is the potential application in Shore side Power Banks (SPB), as presented in the figure below (one of the SSE type arrangements which is featured in the present Guidance – see Part 2 Section 4).

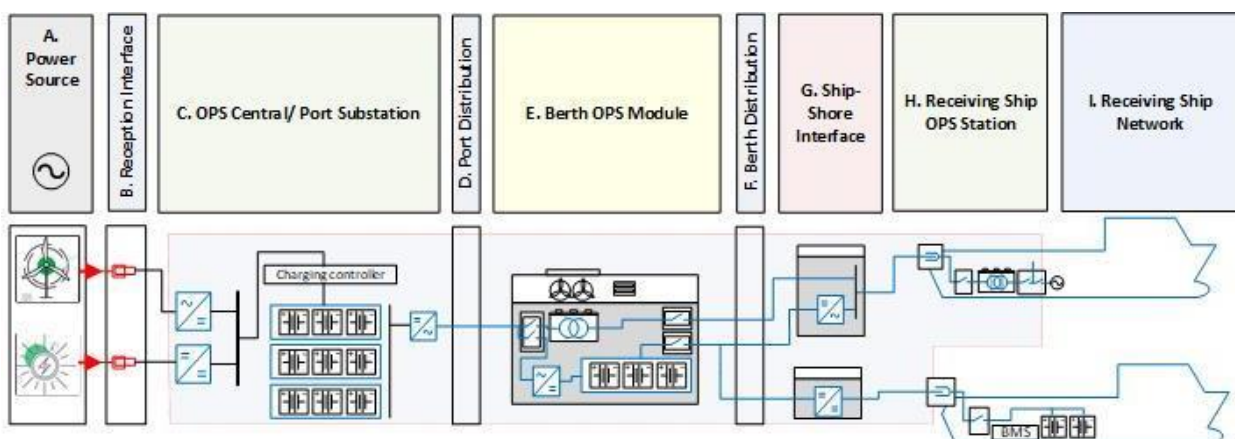

Figure 3.90 - Shore side power bank. Example of clear potential application of EES in ports.

Source: EMSA

SPB have the potential to transform irregular and interruptible Renewable Energy production into a dispatchable and available electrical energy source for any given power rating, over a defined period of time. The example presented includes Onshore Power Supply (OPS) and Shore-side Battery Charging (SBC). Battery groups are presented at both Port Substation level, assisting the wider port grid, and at berth level, targeted at a potential backup instantaneous supply for SSE.

3.10.1 Functional elements of Energy Storage Systems

EES systems reversibly convert energy into electrical energy, vice versa, and store energy internally. An EES system consists of numerous components, all of which are vital to the operation of the system. Although minor differences exist between storage technologies, a block diagram similar to the figure below can be mapped to every EES system.

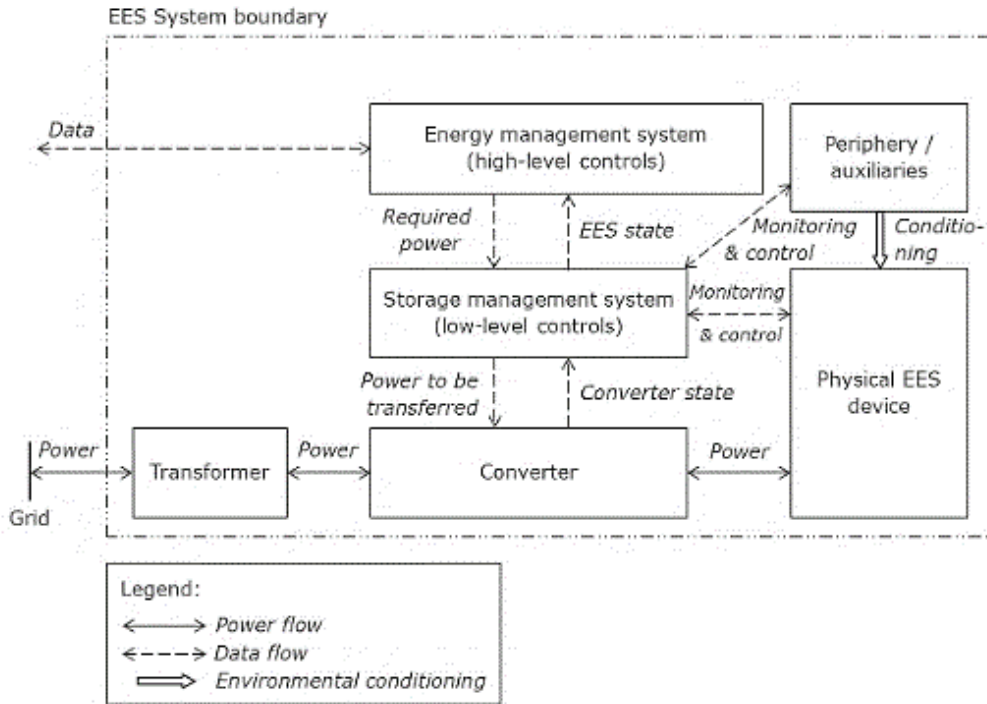

Figure 3.91 - Generic diagram of an EES system showing EES device, converter, auxiliaries, and management systems.

Source: DNVGL-RP-0043 [19]

The core of the EES system is the energy storage device itself where the physical process of storing energy takes place. In most practical applications, this process relies on an electrical (e.g. capacitors), electrochemical (e.g. batteries) or mechanical (e.g. flywheels) working principle. In many cases of grid-connected energy storage, a power converter between the electric power of the grid and the physical energy storage is required; this may be a single converter or a distributed conversion system. In other instances, a motor-generator is connected to the grid through a variable frequency drive or directly; in the latter case, the power converter is used to generate an excitation voltage, or it is absent. Furthermore, a transformer is generally present between the grid and the EES system. The state of the physical energy storage is monitored and controlled by the system's low-level controls, the storage management system, which in case of batteries (cell-based and redox flow) and capacitors is referred to as battery management system (BMS) and capacitor management system (CMS), respectively. It reads all relevant data from the physical storage, for example, in case of batteries, voltages, currents and temperatures. Furthermore, it ensures that the system is working within its operating range and checks whether the electric power requested is within the operating range of the current system status. The high-level controls (energy management system, EMS) of the EES system determine its functionality. They determine when and at what rate the storage system shall be charged, idle or discharged. Depending on the functionality of the system this can happen locally with minimal response times (milliseconds and below) based on locally measured data (e.g. current, voltage, power, frequency), or within an external energy management system, connected via a digital protocol (DNP3, Modbus, etc.), which leads to slower response times (seconds). When the system is set up for multifunctional performance a combination of local and external high-level controls is possible.

3.10.2 Types of Energy Storage Systems

There are five broad storage classes according to the form of energy inside the storage medium: electrical, electrochemical, mechanical, chemical, and thermal. There are technologies from each class already deployed in the grid and there are others at various stages of maturity. The technologies mainly applicable for grid-connected storage are shown in the figure below. A red dashed rectangle indicates the likely area of applicability for port grids.

Short descriptions of the main technology classes for EES systems are given below the figure with reference to the technologies found to be more suitable for port grid applications, with a special attention to SSE. Chemical storage and thermal storage are not considered in this RP. An example of chemical storage is hydrogen (e.g. in the electrolyser/hydrogen storage/fuel cell combination). It should be noted that within each technology, many sub-technologies may exist, with widely differing properties. For example, lead acid batteries can be of the AGM, flooded, gel or lead crystal types, with significant differences in performance, lifetime, safety, etc

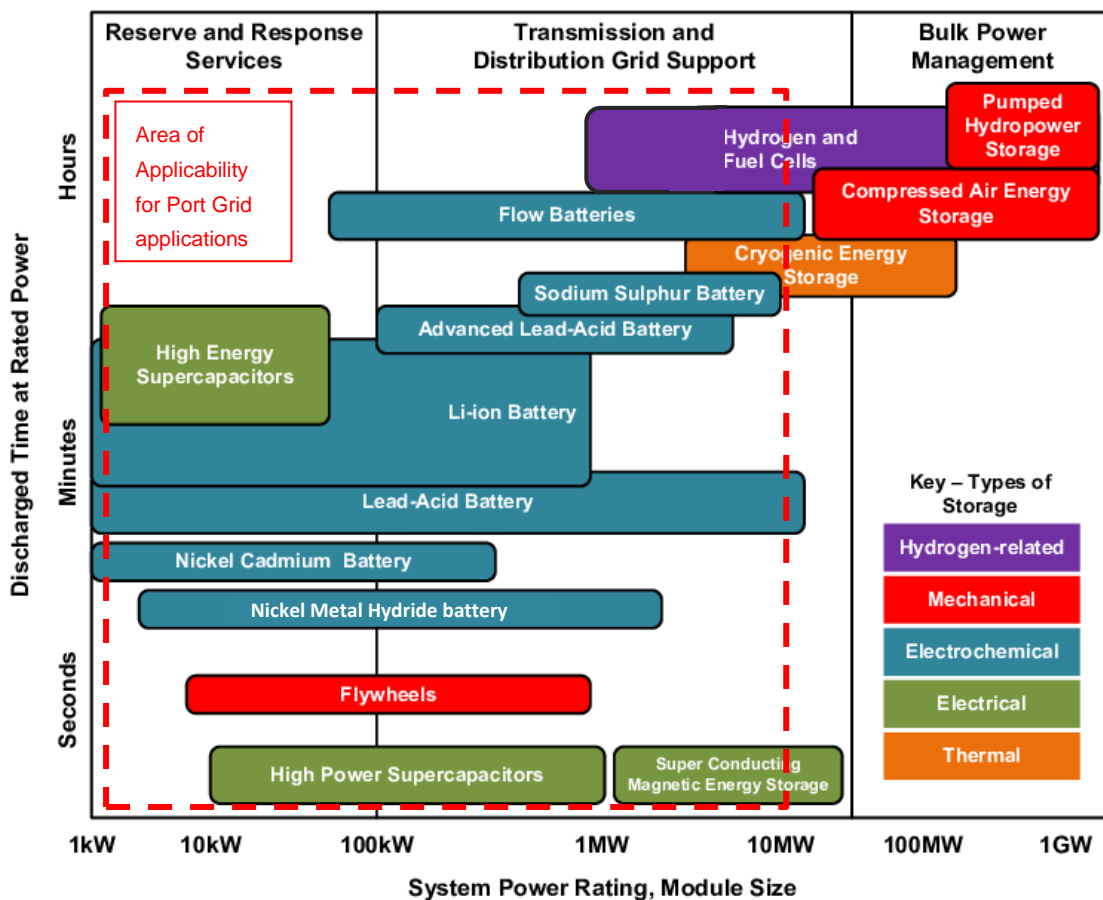

Figure 3.92 - Types of electrical energy storage systems.

Note: The red dashed rectangle indicated the area of applicability for ports, with special consideration for SSE applications.

With reference to the figure above, a brief description of the different relevant EES types is made below, focusing only on those falling within the port grid applicability region, excluding Cryogenic Energy Storage (CES) or Flywheels, both considered of limited interest for port-scale applications:

- **Room-Temperature batteries** (li-ion, nickel cadmium and hydride or lead-acid), represent the most widely applied battery-EES systems deployed both in stationary and mobile/transport applications. They consist of the application of large numbers of electrochemical cells, organized in multiple strings/racks of several modules. The battery system is part of the EES system and includes the disconnect devices and protective circuits. The battery system-BMS collects and aggregates all information from the connected racks and sends them to a superior control, i.e.

the energy management system of the EES system. Multiple racks are connected to one conversion system which may have multiple converters. The converter has converter controls. Overall it is the system demand controller that communicates with the grid operator.

Battery systems are the ones with largest flexibility, in particular the family of Li-ion batteries which can be sized for a large power rating range, despite their relatively reduced energy density. Supply of energy at rated power would however only be possible for a limited period, always in the range of some minutes up to an hour.

- **High-Temperature batteries** (sodium-sulphur, NaS, or sodium-nickel chloride) – battery types that use Na⁺ ions as energy carriers. They need molten sodium as a cathode, making it necessary to operate at 300°C. Commercially available batteries use solid state beta alumina as electrolyte. Functional elements of the whole HT battery groups are similar to room-temperature batteries. Thermal management is the main difference (which is a problem for simple transport applications, being however less of a problem for stationary solutions. HT batteries provide for high power and high energy densities, being able to provide a sustained power for a longer period of time when compared to similar sized LT batteries.
- **Supercapacitors** Capacitors store electricity in a form of electrostatic energy – as opposed to batteries which store energy through related electrochemical reactions. The principle is shown in Figure 3.93. While ceramic as well as electrolytic capacitors use a dielectric to store this electrostatic energy, Electric Double Layer Capacitors (EDLC, supercapacitors or ultracapacitors) are forms of capacitors which utilize a liquid electrolyte (as with lithium-ion batteries) to create a Helmholtz layer at the interface of the solid and liquid. In this way, supercapacitors or EDLC bridge the gap between low energy high power capacitors and high energy low power lithium-ion batteries (see figure below).

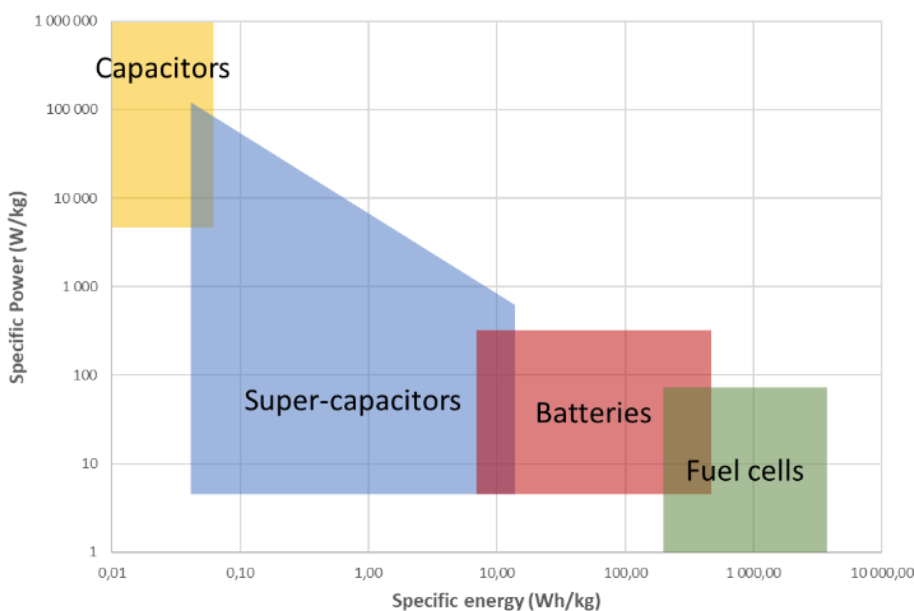

Figure 3.93 - Comparison of different electrical vs electrochemical EES technologies.

Source: EMSA Maritime Battery Study¹⁴

- **Flow batteries.** Flow batteries, much like any other electrochemical cell, generate a voltage between two electrodes as electrons move through an electrolyte. Whereas in conventional

¹⁴ EMSA Maritime Battery Study download at <http://www.emsa.europa.eu/publications/reports/item/3895-study-on-electrical-energy-storage-for-ships.html>.

batteries such as lithium-ion, the electrodes comprise of metal or carbon, and the electrolyte remains fixed between them; flow battery works by pumping a charge carrying fluid, the electrolyte, which is stored in tanks, through the separated electrodes to generate this voltage and current. The electrolyte at the anode is called analyte and the electrolyte at the cathode is called catholyte.

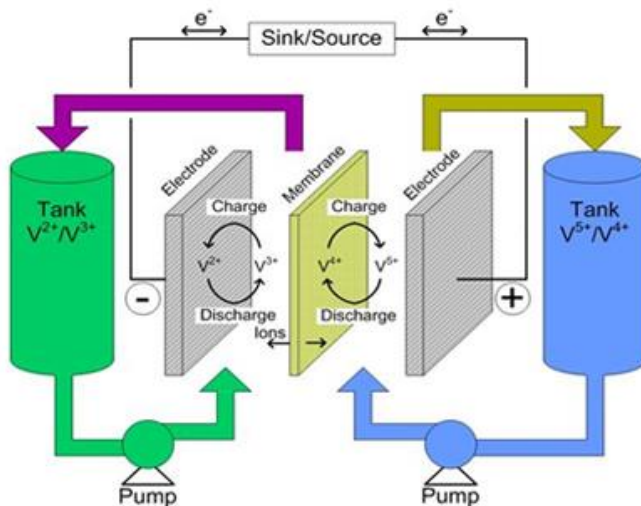

Figure 3.94 - Flow battery diagram representation [20].

The advantage is that the energy capacity of the battery then is limited only to the size of the electrolyte tanks, and can be, theoretically, infinite. In addition, the power capability is also easily increased by simply adding more cell stacks as the battery's energy and power are completely configurable. Additionally, the lifetime of the system may be significantly prolonged by comparison, since it is not subject to the same degradation mechanisms found in more traditional batteries. Though the systems present risks for mechanical failure that traditional batteries would not be subject to, these repairs are more minor in scale and likely familiar to service technicians. These systems have low flammability risks.

The main disadvantage of such batteries are the low energy density of 20-60 Wh/L and specific energy of 20-35 Wh/kg. The high price of electrolytes also hinders the application in many fields. Hence it is considered suitable for stationary applications, and not electric vehicles or vessels.

- **Hydrogen and Fuel Cells** represent an important option when hydrogen production can be obtained from renewable energy sources. When renewable energy supply is in excess to the demand it is possible to use the surplus electricity to obtain Hydrogen from Water, via Proton Exchange Membrane electrolyzers. The hydrogen produced is then stored in a suitable medium (chemical, cryogenic liquid, pressurized or metal hydride). To use the energy stored, a Fuel Cell system installation needs to be installed. The full Hydrogen based EES is composed of the 3 elements (electrolyser, H₂ storage and fuel cell), as shown in the diagram in the following figure).

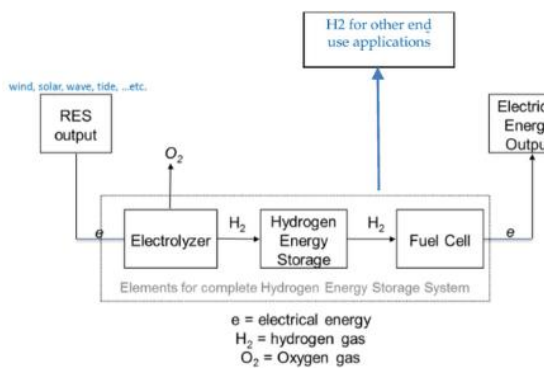

Figure 3.95 - Hydrogen based EES [21].

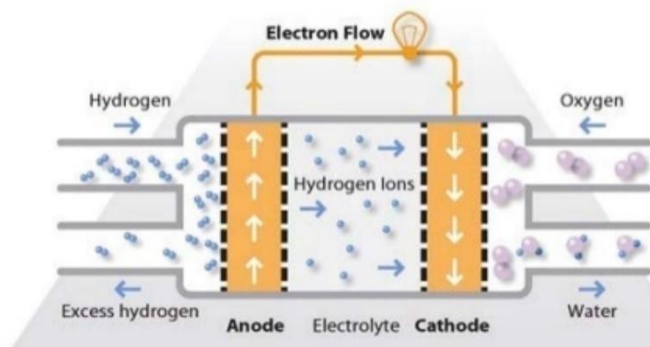

Figure 3.96 - Hydrogen based EES.

Source: EMSA Study on the use of Fuel Cells in Shipping¹⁵.

3.10.3 Applications and opportunities for EES in ports and SSE.

A large number of applications and opportunities for EES in Utility grids are currently well documented. The same level of information is difficult to find for port scale applications, with or without connection to SSE infrastructure. Ports are in fact very different amongst themselves and finding a reference characteristic port is difficult.

In order to determine the full-scale potential of EES options for ports it is important to characterize first the port energy ecosystem and the wider context in integration of SSE infrastructure. The following important factors need to be considered by PAA before concluding on the scale and integration of EES systems:

- A. Type and size of terminals (cargo, bulk, containers, passengers/RO-Pax, RO-RO), with some ship types requiring high levels of energy security whilst at berth (passenger ships, RO-Pax). It may be a customer requirement to have electrical energy secured by EES from shore (this may be the case of any ship which at-berth operating profile is presented as high energy-dependent, either from a load demand or safety perspectives).
- B. Resilience of the Utility and Port Grids, identifying potential factors affecting energy security, quality, and infrastructure. Redundancy levels, margin for growth in existing power and current rating of equipment and conductors, respectively, are all important aspects to consider in the wider context of grid resilience.
- C. Ability to deal with peak power stress when multiple ships are coincidentally supplied by the same SSE infrastructure there may be moments where available power supply and point load demand may have to be reconciled. This is only possible in two ways: 1) energy management with limitations imposed on ships in order to limit onboard consumption or 2) providing for EES supported peak energy
- D. Electrical Energy security, with a possible level of energy security to be identified by PAA in conjunction with the wider port services community, in particular with Utility operators, terminals and SSE services suppliers and facility operators.
- E. Power Quality aspects, addressing a possible log of historic occurrences with voltage/frequency/harmonics associated to issues in utility grid stability.
- F. Level of Integration of SSE infrastructure within the port grid. The more integrated SSE infrastructure is within the port grid (e.g. sharing common HV centralized substation within the port) the more prone it will be to fluctuations or instabilities in the port grid.

¹⁵ EMSA Study on the use of Fuel Cells in Shipping download at <http://www.emsa.europa.eu/sustainable-shipping/alternative-fuels.html>.

- G. Dependency of SSE services from the port grid supply. SSE systems may range from fully dependent on port grid to “island” mode operation. When designed in a microgrid¹⁶ concept the SSE system requires EES for continuity in operation in independent mode.
- H. Use of Port Electricity Generation, with the potential fluctuations of synchronous generators (e.g. internal combustion engines running on alternative fuels) requiring EES support. The use of EES would also allow generators to run at constant load, decoupling demand load variations from power supply (peak shaving, resulting in immediate fuel savings and energy efficient operation)
- I. Risk Assessment, where identified EES as a risk control option to mitigate unacceptable risk levels associated to occurrence of power outages, power quality fluctuations or emergency response.
- J. Renewable Energy resources installation in Port Area, leading to the necessary installation of EES to store irregular energy generation from solar/PV or wind. EES may in this case be also needed for power quality control.

The table below lists a number of different potential applications for EES systems in ports, considering the above port-specific aspects.

Table 3.22 – Energy storage systems applications for ports and SSE.

EES applications for ports and SSE	Short description	Added Value for SSE	Response time	Candidate EES technology options
Load following/power ramp modulation	Power balancing application used to control load variations. It is used as a form of load ramp rate control. When load varies too rapidly, EES can provide for power compensation.	Application justified where rapidly SSE varying loads are expected. Rapid response is required.	< 1 second	Batteries, redox flow batteries
Regulation/response to peak power	When it is needed to reconcile demand and supply/generation inside the port area, EES can be used to momentary provide the additional power needed.	EES could be advantageous when supplying OPS to ships with strong varying loads, where the occurrence of significant peak loads could	< 5 seconds	Batteries, redox flow batteries, supercapacitors,
Frequency response	Function consisting of a response to a change in the grid frequency, with the purpose to counteract this change in frequency. EES can add inertia into the grid, counteracting the frequency deviations and supporting a smoother transition from an upset period back into stabilization.	When SSE infrastructure is supplied by unstable grid it is important to ensure a good degree of frequency warranty. This can be provided by EES. Quality of port grid electricity can be affected by load varying elements, sudden partial outages, and other instability	Few milliseconds to 0.1 seconds	Batteries, supercapacitors,
Backup power/uninterruptible power supply	Stored energy reserves are usually charged EES backup systems that have to be available for discharge when required to ensure grid stability. An example of an operating reserve is an uninterruptible power supply (UPS) system, generally containing one or more EES systems, which can provide near to instantaneous power in the event of a power interruption or a protection from a sudden power surge.	SSE systems may use UPS supports at berth level, providing rapid electrical energy backup in case of power outages. This may represent an important element in support of SSE energy security when considering specific ship types.	Milliseconds to seconds	Batteries, redox flow batteries

¹⁶ A microgrid connects to the grid at a point of common coupling that maintains voltage at the same level as the main grid unless there is some sort of problem on the grid or other reason to disconnect. A switch can separate the microgrid from the main grid automatically or manually, and it then functions as an island.

		UPS services are necessarily short-term supplies. They may bridge the time gap between power outage and onboard generators back to line, mitigating the risk of undesired blackouts.		
Voltage support	<p>Voltage support is especially valuable during peak load hours when distribution lines and transformers are the most stressed. An application of an EES system could be to serve as a source or sink of the reactive power. These EES systems could be placed strategically at central or distributed locations.</p> <p>Voltage support typically is a local issue at low voltage (LV), or high voltage (HV) level.</p> <p>The distributed placement of EES systems allows for voltage support near large loads within the grid.</p>	Added value mainly for ports which provide for SSE supply to several ships simultaneously. Where different peak loads coincide, the port distribution lines and transformers can be alleviated by local voltage support	Seconds	Batteries and redox flow batteries
Black start	Following a catastrophic failure of a grid, the EES system provides an active reserve of power and energy which can be used to energize distribution lines, provide start-up power for one or more diesel generators and/or (larger) power plants and provide a reference frequency.	Black start has a potential role specifically for ports which make use of port generators (both for primary and secondary/emergency supply)	Minutes	Batteries and redox flow batteries
Power quality	<p>Events in the transmission and distribution network may cause short-duration disturbances that could be harmful for sensitive processes and loads at onboard SSE supplied ships:</p> <ul style="list-style-type: none"> • Variations in the primary frequency. • Flicker, which is the change in luminance of a source of illumination due to fluctuations in the voltage magnitude. • A low power factor, during which voltage and current are out of phase with each other, creating unnecessary reactive power flows. • Interruptions of service, ranging from a fraction of a second to several seconds. • Variations in voltage magnitude, for example short-term spikes or dips, longer term surges or voltage sags. The countermeasure for this is called low voltage ride-through. • Harmonics, which are voltages or currents at frequencies other than the primary frequency 	<p>Ship grids, and onboard equipment are sensitive to power quality variations. EES may support improved power quality levels allowing for a better experience on the ship side and mitigating the risk for power quality related disputes</p>	Milliseconds	Batteries, capacitors, supercapacitors

Power reliability in grid-connected operation	EES systems, in their role of power reliability service, may effectively support customer loads, i.e. as a stationary backup in case of outage of the primary electric grid. Similarly, in a post-disaster or emergency power situation, mobile systems can be brought in to provide power during outages. A temporary local island, also known as a microgrid, is then created where power availability is maintained. This microgrid is required to resynchronize with the utility grid when grid power is restored. The duration over which islanded operation can be maintained is determined by the size of the EES system, and also influenced by e.g. additional (renewable) generation sources.	EES support to SSE microgrid operation in "island" mode. Support to grid power restoration.	Milliseconds	Batteries
Power reliability in microgrid operation	Microgrids have two distinct modes of operation: parallel mode, when the microgrid resources operate in parallel with the primary electric grid, and islanded mode, when the microgrid forms a self-sustaining island disconnected from the primary grid. During parallel operation, EES systems within a microgrid can enhance the efficiency of local resources, reduce import from the primary electric grid and enable higher levels of renewable integration. Microgrid EES systems can smooth (time-scale of seconds), firm (time-scale of minutes) or shift (time-scale of hours) intermittent renewable generation by providing instantaneous ramping and sustained energy throughput while charging or discharging.	EES support to SSE microgrid operation in "island" mode. Support to sustained island mode operation.	Milliseconds	Batteries, supercapacitors
Renewable energy optimization and integration	Ports, very much like industry or small local communities, may take advantage of microgrid Renewable Electrical Energy production. Wind and solar/PV are common likely candidates, but others are also possible depending on local availability of renewable resources. Reasons for this application may be decreased CO ₂ emissions, increased self-sufficiency or to increase fuel savings in microgrids. EES are essential elements to allow renewable electricity to be integrated into the grid. When production is higher than consumption, the energy is stored. When production is insufficient, the EES is used for power supply.	Due to low power/energy throughput, and irregular production, of renewable electricity production, EES is fundamental for intermediate energy storage. With EES it is possible to implement adequate energy/power supported microgrid-based SSE systems	seconds	Batteries and redox flow batteries

3.10.3.1 Battery Technologies

Having recognized the key relevance of electrical and electrochemical based EES, the table below present the most relevant existing commercially available battery chemistries that may be considered for stationary applications.

Table 3.23 – Most relevant battery technologies for stationary applications.

Battery technology	Specific energy [Wh/kg]	Advantages	Disadvantages	Applicability for Port Scale applications and SSE systems/operation
Lithium-ion - Nickel manganese cobalt oxide (Li-NMC)	150-220	Combination for High Specific Energy Adjustable power density, energy density cost and safety	Key properties equilibrium may be difficult to ensure for a stable lifespan	Flexible design with respect to energy and power capabilities. The most used chemistry in marine applications at present
Lithium iron phosphate (LFP)	90-120	Higher Safety Characteristics Resilient to temperature fluctuations Cathode doping possible for higher power applications	Relatively low Specific Energy Lower Voltage Lower power capabilities	Used in marine applications because of its good safety features.
Nickel Cobalt Aluminium (NCA)	200-260	High specific energy and energy density Good calendar life	Lower safety Higher cost	Suitable because of its high energy density
Lithium cobalt oxide (LCO)	150-240	High specific energy and energy density	Lower Power (rate) Shorter Cycle Life Impedance increases over time Safety concerns (thermal stability)	Suitable because of its high energy density Drawbacks such as shorter cycle life and safety concerns makes it less attractive compared to other Li-ion chemistries
Lithium manganese oxide spinel (LMO)	100-150	Higher Thermal stability Current material modifications possible to improve Cycle Life	Lower energy capacity Shorter Cycle Life at higher temperatures	Shorter cycle life makes it less attractive compared to the other Li-ion chemistries
Lithium Titanate Oxide (LTO)	50-80	Higher safety characteristics Very high cycle life High power capability	Relatively low specific energy Initial cost is high, but total lifetime cost might be cheaper	Suitable for applications that require fast charging, high power, or very large amounts of cycling
Lead-acid	33-42	Very low cost Electrodes and electrolyte not flammable Commercially available worldwide High specific power	Low specific energy and energy density Low cycle life	Too low specific energy and energy density
Nickel Cadmium	40-60	Very low cost Only battery that can be ultra-fast charged with little stress Electrodes and electrolyte not flammable Commercially available worldwide	Low specific energy and energy density Explosive hydrogen gas during charge Memory effect Cadmium is a toxic metal. Cannot be disposed of in landfills	Too low specific energy and energy density

		<p>Good load performance; forgiving if abused</p> <p>Good low-temperature performance</p>	<p>High self-discharge; needs recharging after storage</p> <p>Low cell voltage of 1.20V requires many cells to achieve high voltage</p>	
Nickel Metal Hydride (NiMH)	60–120	<p>Low cost</p> <p>Electrodes and electrolyte not flammable</p> <p>30–40 percent higher capacity than a standard NiCd</p> <p>Less prone to memory than NiCd, can be rejuvenated</p> <p>Simple storage and transportation; not subject to regulatory control</p> <p>Environmentally friendly; contains only mild toxins</p> <p>Nickel content makes recycling profitable</p> <p>Wide temperature range</p>	<p>Relatively low Specific Energy and energy density</p> <p>Release of hydrogen gas during charge, with potential for creation of explosive atmosphere.</p> <p>High self-discharge rate</p> <p>Limited service life; deep discharge reduces service life</p> <p>Requires complex charge algorithm. Sensitive to overcharge</p> <p>Does not absorb overcharge well; trickle charge must be kept low</p> <p>Generates heat during fast charge and high-load discharge</p> <p>High self-discharge</p> <p>Coulombic efficiency only about 65% (99% with Li-ion)</p>	<p>High self-discharge rate</p> <p>Limited application for stationary application in SSE due to the high energy and power requirements for the majority of ships.</p>
Nickel Iron (NiFe)	50	<p>Long lifetime</p> <p>Resilient to vibrations and high temperature</p>	<p>Low specific energy and energy density</p> <p>High cost</p> <p>High self-discharge rate</p> <p>Poor low temperature performance</p>	<p>Too low specific energy and energy density</p> <p>High self-discharge rate</p> <p>High cost</p>
Nickel Zinc (NiZn)	100	<p>No toxic materials</p> <p>Low cost</p> <p>High power output</p> <p>Good temperature operating range</p>	<p>Low specific energy and energy density compared to lithium-ion</p> <p>Dendrite growth</p> <p>High self-discharge rate</p>	<p>Not suitable due to high discharge rate and safety characteristics.</p>
Nickel Hydrogen	40-75	<p>Long lifetime</p> <p>Minimal self-discharge rate</p> <p>Good temperature operating range</p>	<p>Low specific energy and energy density compared to lithium-ion</p> <p>High cost</p>	<p>Too low specific energy and energy density</p>
High temperature Sodium Sulphur (NaS)	760 (Practical 140-240)	<p>High power</p> <p>High energy density</p> <p>High efficiency</p> <p>Temperature stability</p> <p>Low cost of raw materials</p> <p>Commercially available</p>	<p>Unsafe: Fracture of beta alumina leads to violent reaction</p> <p>High operating temperature (300°C)</p> <p>Molten sodium electrode</p> <p>Uses 10-14% of its own capacity to maintain the operating temperature when not in use</p> <p>Expensive due to manufacturing process, insulation requirements and thermal management</p>	<p>Requirements for high operating temperature, expensive and safety features</p> <p>NaS technology has however been deployed in significant scale EES systems today, representing</p> <p>It may represent a good option for long discharge cycles in SSE installations associated to wider availability of renewable resources.</p>

ZEBRA	788 (Practical 120)	High voltage Safe: No gassing Tolerance against overcharge Low cost of raw materials Commercially available	Preheating to the operating temperature High operating temperature (300°C) Molten sodium electrode Uses 10-14% of its own capacity to maintain the operating temperature when not in use Manufacturing process, insulation requirements and thermal management make the batteries expensive	Requirements for high operating temperature, expensive
Super Capacitors	0.01-15	Very high specific power Commercially available Safe	Very low specific energy and energy density	Suitable for peak shaving applications, where the need for energy storage capacity is low Suitable for SSE where immediate high power may be required.
Flow batteries	20-35	Can decouple energy and power characteristics Easy to scale up energy and power capabilities Low flammable risk	Very low specific energy and energy density Toxic fluids	Low energy density and specific energy. Adequate for port stationary applications if space does not represent a limitation. Scaling up characteristics may become very interesting for a phased-in adoption of this EES technology.

3.10.3.2 Hydrogen

Hydrogen based EES are the systems with the highest potential for sustained supply operation and for the highest power and energy levels, when compared to electrical or electrochemical EES.

Hydrogen based EES can be adequate solutions where:

- Where renewable energy resources and production are widely available, resulting in high electrical energy production throughput.
- Where space is not available in the port area for large footprint battery-based EES.
- Where a large number of different ship types require SSE supplies at both High Energy and High-Power requirements.

It has to be noted that, due to low efficiency hydrogen production process, the use of Hydrogen based EES is only adequate for renewable energy storage. Current technology maturity of these systems is still challenged by developments on the electrolyser side. Storage of hydrogen (compressed, liquefied, ammonia or other) and Fuel cell technology are today more advanced and giving secure steps towards commercial application.

The single-line diagram in the figure below illustrates the different elements present in a hydrogen based EES.

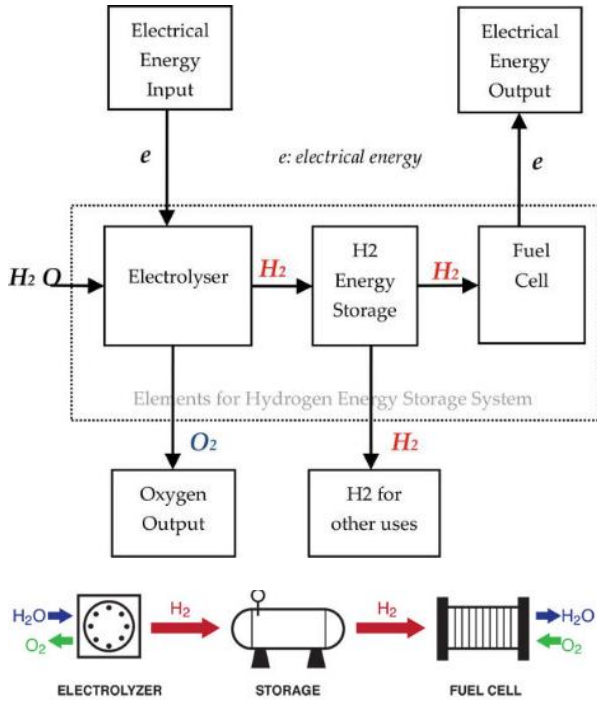

Figure 3.97 - Relevant key Switchboard locations – Central OPS substation and Berth OPS Module [21].



(a)



(b)

Figure 3.98 – (a) Renderization of a hydrogen energy storage unit comprising of hydrogen storage, electrolyser units and fuel cells (b) Solid Oxide Fuel Cell in containerized unit.

The example represented in (b) is of a reversible SOFC unit, i.e. fuel cell and an electrolyser at the same time, producing and storing hydrogen when renewable power is available and consume the same hydrogen to produce electricity supply.

Source: (a) Alencon Systems, LLC (b) Boeing

3.10.4 Technical standards and references – Electrical Energy Storage systems

Below, a list of relevant references on EES systems is presented, with a strong focus on battery-based systems.

Electrical Energy Storage systems - Reference Standards:

- A. Recommended practice — DNVGL-RP-0043. Edition September 2017 - Safety, operation and performance of grid-connected energy storage systems
- B. EMSA Study on Electrical Energy Storage for Ships - 2020
- C. Directive 2006/66 (Battery Directive) on batteries and accumulators and waste batteries and accumulators
- D. IEC 62619 (2017): Secondary cells and batteries containing alkaline or other non-acid electrolytes –Safety requirements for large format secondary lithium cells and batteries for use in industrial applications
- E. IEC 62620 (2014): Secondary cells and batteries containing alkaline or other non-acid electrolytes – Large format secondary lithium cells and batteries for use in industrial applications
- F. IEC 61427 -1: Secondary cells and batteries for renewable energy storage – General requirements and methods of test – Part 1: Photovoltaic off-grid application
- G. IEC 61427-2: Secondary cells and batteries for renewable energy storage – General requirements and methods of test – Part 2: on-grid applications
- H. IEEE 1375: IEEE Guide for the Protection of Stationary Battery Systems
- I. IEEE 1491: IEEE Guide for Selection and Use of Battery Monitoring Equipment in Stationary Applications
- J. IEEE 1679: IEEE Recommended Practice for the Characterization and Evaluation of Emerging Energy Storage Technologies in Stationary Applications
- K. IEEE 484: Recommended Practice for Installation and Design of Vented Lead-Acid Batteries for Stationary Applications—
- L. IEEE P2030.3: Standard for Test Procedures for Electric Energy Storage Equipment and Systems for Electric Power Systems Applications
- M. IEC 62933-1: Electrical energy storage (EES) systems – Part 1: Terminology
- N. IEC 62933-2-1 (under development): Electrical Energy Storage (EES) systems – Part 2-1: Unit parameters and testing methods – General specification
- O. IEC 62933-3-1 (under development): Electrical Energy Storage (EES) systems – Part 3-1: Planning and installation – General specification
- P. — IEC TS 62933-4-1 (under development): Electrical Energy Storage (EES) systems – Part 4-1: Guidance on environmental issues
- Q. — IEC TS 62933-5-1 (under development): Electrical Energy Storage (EES) systems – Part 5-1: Safety considerations related to grid integrated electrical energy storage (EES) systems
- R. IEC 62933-5-2 (under development): Electrical Energy Storage (EES) systems – Part 5-2: Safety considerations related to grid integrated electrical energy storage (EES) systems – Batteries
- S. ANSI/CAN/UL-9540: 2016 Standard for Safety, Energy Storage Systems and Equipment (under continuous maintenance) – this standard is used to test and then certify energy storage systems as to the safety
- T. NFPA 855, Standard for the Installation of Energy Storage Systems (first draft under development)
- U. UL 810A: Electrochemical Capacitors
- V. IEC 62813 Lithium-ion capacitors for use in electric and electronic equipment – Test methods for electrical characteristics— Flow batteries – Guidance on the specification, installation and operation, CENELEC Workshop Agreement, CWA 50611, April 2013
- W. IEC 62932-1 (under development): Secondary Cells and Batteries of the Flow Type: Flow Batteries –Guidance on the Specification, Installation and Operation
- X. IEC 62932-2-1 (under development): Flow batteries – General requirement and test method of vanadium flow batteries
- Y. IEC 62932-2-2 (under development): Flow Battery Technologies – Safety

3.11 Ship-shore connection equipment

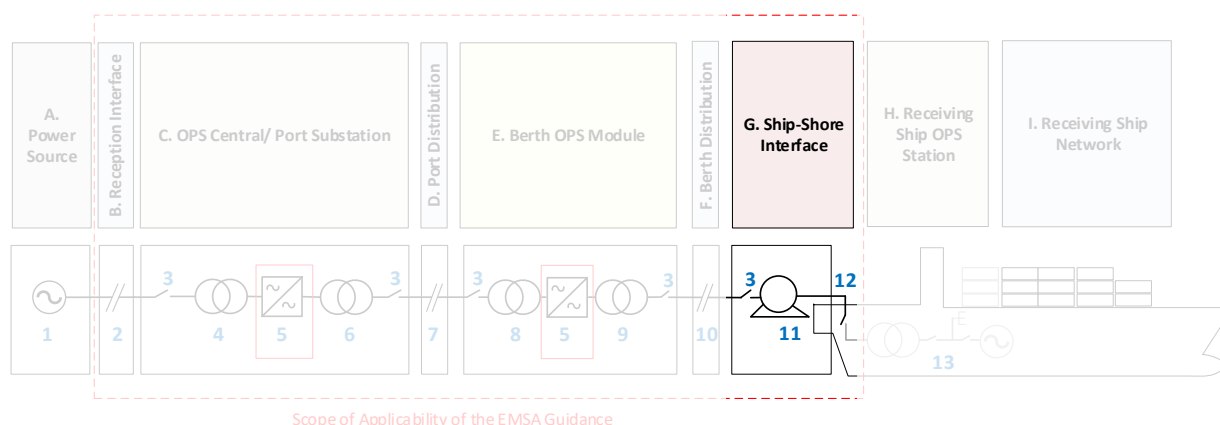

Figure 3.99 – Ship-shore interface.

Source: EMSA

The Ship-Shore connection in SSE is an important system, composed of the following equipment:

- Ship-to-shore SSE connection cable, to ensure the transmission of electricity from shore to ship, at specified voltage and current ratings, dimensioned to cope with both electrical and mechanical requirements for the intended conditions of use.
- Cable Management System, designed to handle the SSE electrical connection cable and connectors, ensuring that a mechanical ship-shore connection is viable under different conditions.
- Connectors, to allow mechanical plug-in electrical connection between shore and ship side.
- Interlocking, Earthing Switches and Safety Functions, to ensure essential electrical safety functions in the ship-shore connection. Emergency Shutdown functions are covered by this point.
- Control and Monitoring cable, whenever some degree of automation is involved this is also an aspect which is under the umbrella of the ship-shore connection.
- Data communication, covering the exchange of relevant data, including power quality, operation logging data and alarm notifications (with or without ESD action).

Listed equipment works together in the ship-shore interface to ensure a safe SSE connection and, ideally, all elements should be part of one assembled system, resulting from the design of one system integrator, ensuring that all elements are part of one single safety concept, working adequately together with minimum systems barriers/interfaces.

All equipment in the ship-shore interface, used to ensure SSE connection, represent critical elements for interconnectivity and interoperability. Applicable international standards should be mandated for the certification and operation of ship-shore connection equipment and systems.

Section 3.11.1 identifies the six main roles that should be present in the ship-shore connection, section 3.11.2 lists relevant aspects of shore power connection cables, section 3.11.3 highlights some characteristics of different Cable Management Systems, without including ship-specific aspects and section 3.11.4 presents different connectors, both standardised and alternative proprietary solutions, for both OPS and Battery Charging.

Ship-shore connection standardisation for interconnectivity and interoperability is not fully ensured for all possible situations and system configurations, as it is presented in Part 2 Section 5 with a direct relation, as expected, between experience and maturity of systems and operation, and international agreed standardisation. The importance of harmonization of both connectivity solutions and operations is however fundamental to support development of SSE projects and to ensure adequate support to safe operation of SSE connected ships.

3.11.1 Functions at the SSE Ship-Shore Connection

Being a system of central relevance in the SSE the Ship-Shore Connection has to be able to meet several roles in addition to the primary role of electricity supply. The diagram below presents these roles in the ship-shore connection. To be noted the location of the Cable Management System (CMS) on both ship and shore sides. In practice, depending on the ship type¹⁷, the CMS will be located only on one or the other side.

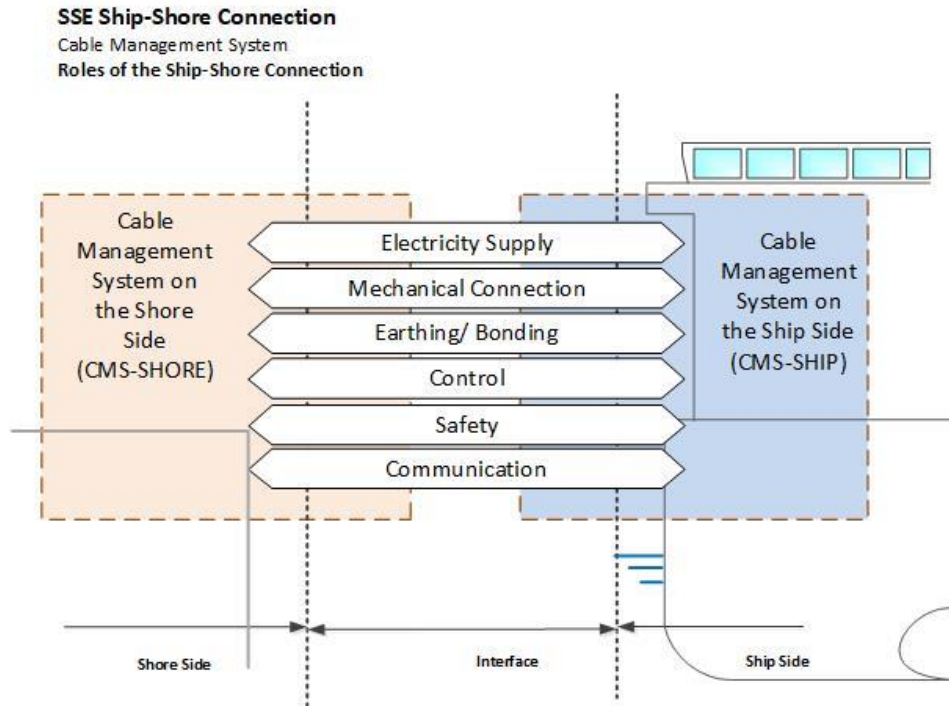

Figure 3.100 – Functional elements at the ship-shore connection.

Source: EMSA

The Communication role incorporates active operational communications and automated data exchange.

Ideally all functions should be provided by the minimum number of connections as possible. The ideal case would be for all functions to be in fact integrated into a single cable/single-point connection. This is however not always practicable and, unless an alternative approach is followed, the Annexes of both standards IEC/IEEE80005-1/3 should be followed. Not all ship types are covered but it is possible to get a fairly well-defined harmonization within each ship type, for HV and LV respectively.

High Voltage shore-power arrangements have a great advantage over Low Voltage: a reduced number of power cables, for the same power demand, with strong efficiency and logistic implications. Less time for connection, less manpower, less risk involved. For 1kVA power demand (approximately 800kW for a Power Factor of 0.8) the expected current in peak power operation would be:

High Voltage (6.6kV):

$$P = VI$$

$$I = \frac{P}{V} = \frac{800000W}{6600} = 121.2A$$

Low Voltage (400V):

$$P = VI$$

$$I = \frac{P}{V} = \frac{800000W}{400} = 2000A$$

¹⁷ Annexes to IEC/IEEE 80005-1 and 3 include the detailed standardisation aspects for SSE OPS ship-shore connection for different ship types, for High Voltage and Low Voltage, respectively.

For lower voltages, such as it can be seen from calculations, for the same power demand, a higher current is to be expected in the connection. To manage current within acceptable levels in each electrical cable the number of cables had to be increased in a parallel shore-connection arrangement. Table 4.7, in Part 2 Section 4.3.2, shows the indicative number of cables, and respective maximum operation current in Amperes for different power demands and 3 different voltages, 400, 440 and 690V.

The images below illustrate the challenging situation for LV connections of ships requiring higher power supply for OPS.



Figure 3.101 (a) and (b) – Multiple electrical cables are involved on low voltage shore connections.

The need to reduce the number of cables, improve timing for connections and reduce risk led to the promotion of high voltage applicable to ships with higher power demands.

It can be considered that HV represents an evolution in OPS, which enables power supply to higher consuming ships, whilst managing to keep number of cables at a minimum. Representing an evolution doesn't necessarily mean that LVSC becomes obsolete. For ships with lower power requirements, low voltage connections will still be the relevant application. HV and LV together are complementary in covering the largest possible scope of ship types and power demand profiles.

3.11.2 Ship-to-shore connection cable

Technical Specifications for shore connection cable should follow Annex-A of both IEC/IEEE 80005-1 and 3 for:

- a. Rated Voltage
- b. General Design aspects
- c. Testing requirements

Voltage Rating

Rated voltage for connection cables is presented in the table below:

- $\frac{U_0}{U}(Um) = \frac{6}{10} (12)kV \text{ RMS}$, rated for a maximum of 12kV (IEC/IEEE80005-1 - HVSC)
- $\frac{U_0}{U}(Um) = \frac{1.8}{3} (3.6)kV \text{ RMS}$, rated for a maximum of 3.6kV (neutral) (IEC/IEEE80005-1)
- $\frac{U_0}{U}(Um) = \frac{0.6}{1} (1.2)kV \text{ RMS}$, rated for a maximum of 1,2kV (IEC/IEEE80005-3 – LVSC)

Voltage rating¹⁸ figures for cables are normally expressed in A.C. RMS. (Alternating Current Root Mean Square) and are written as a figure U_o/U (U_m)

U_o = Rated voltage phase to Earth

U = Rated voltage phase to phase

U_m = Maximum system

Technical Requirements

Table 3.24 – Technical requirements for ship-to-shore connection cables per ship type.

Seagoing Vessels	<p>Cables shall comply with the physical/resistance characteristics outlined by IEC/IEEE 80005-1/3:</p> <ul style="list-style-type: none"> • be at least of a flame-retardant type in accordance with IEC 60332-1-2. • outer sheath shall be oil-resistant and resistant to sea air, seawater, solar radiation (UV) and shall be non-hygroscopic. • The temperature class shall be at least 90 °C. • insulation shall be in accordance with Annex A of the standard. • Correction factor for ambient air temperatures above 45 °C shall be considered according to IEC 60092-201:1994, Table 7. • Maximum operating temperature shall not exceed 95 °C, considering any heating effects (e.g. as a result of cable coiling). <p><u>Standards:</u></p> <p>High-Voltage</p> <ul style="list-style-type: none"> • IEC 60502-2, <i>Power cables with extruded insulation and their accessories for rated voltages from 1 kV ($U_m = 1,2$ kV) up to 30 kV ($U_m = 36$ kV) – Part 2: Cables for rated voltages from 6 kV ($U_m = 7,2$ kV) up to 30 kV ($U_m = 36$ kV)</i> <p>Low Voltage</p> <ul style="list-style-type: none"> • EN 50525-2-22:2011 <i>Electric cables. Low voltage energy cables of rated voltages up to and including 450/750 V (U_o/U). Cables for general applications. High flexibility braided cables with crosslinked elastomeric insulation</i> • Any other international recognized standards <p>Electrical supply cables may incorporate control and monitoring cables, namely by fibre-optics integrated into the main power cable. In this case, control and monitoring cables shall be able to withstand internal and external short-circuits.</p>
Inland Waterways	<p>A flexible cable according to EN 50525-2- 21 shall be used for a shore connection cable according to this European Standard, see Figure 1. In addition, the cable shall meet the following requirements:</p> <p>a) resistance against splash water at least AD6 according to HD 60364-5-51.</p> <p>b) temperature resistance during operation from -25 °C up to +80 °C.</p> <p>c) the cable shall be suitable for being laid outdoors.</p> <p>d) ozone resistance according to EN 60811-403. The test conditions shall be as follows: ozone concentration and test duration according to EN 50363-2-1:</p> <ul style="list-style-type: none"> — test temperature (25 ± 2) °C, — test duration 24 h, — ozone concentration (250 to 300) × 10⁻⁴ Vol-%. <p>e) oil resistance according to EN 60811-404. The test conditions shall be as follows, test according to EN 50363-2-1:</p> <ul style="list-style-type: none"> — oil temperature (100 ± 2) °C, — test duration 24 h. <p>The following values shall be reached: tensile strength: maximum change ±40 %; elongation at break: maximum change ±40 %</p>
Pleasure Craft	<p>Shore Power cable requirements should comply with the standard</p> <ul style="list-style-type: none"> • IEC 60364-7-709:2007+AMD1:2012 CSV (Consolidated version) <i>Low-voltage electrical installations - Part 7-709: Requirements for special installations or locations - Marinas and similar locations</i> <p>Note: Requirements from IEC 60364-7-709:2007 are solely applicable in marinas and similar locations.</p>

¹⁸ The voltage rating of a cable is the highest voltage that may be continuously applied to a completed cable construction in compliance with the relevant cable standard or specification. It's the voltage a cable can remain stable in operation up to. An example voltage rating would be what is often just referred to as 0.6/1kV - it would actually be written as 0.6/1 (1.2)kV or take an example from a higher voltage cable such as the medium voltage 19/33 (36)kV cable. The section in brackets at the end is the maximum voltage the cable can remain stable and safely operate.

Certification

Only certified shore-power connection cables should be used for any SSE applications. Certificate must be kept onboard and available at any time on request, being a fundamental element to allow Compatibility Assessment and First Connection Certification.

Storage

Appropriate arrangements are to be provided for storage of removable HVSC equipment when not in use. Such storage should consider issues such as, but not restricted to, temperature, humidity, moisture, condensation, dirt, and dust, and should protect against the likelihood of physical damage to the cable, plugs, sockets, and associated equipment.

Extensions

As per IEC/IEEE 80005-1/3, no extensions of shore-power cables should be permitted for both HVSC and LVSC.

For inland waterway vessels, extensions are however possible under EN 15869-3:2019, a possibility considered provided compliance with Table A.1 of the standard — Maximum length of a shore connection cable according to EN 50525-2-21 including extension.

Other possible extensions should always be limited to a maximum current rating of 125A. If the current rating is not known, the maximum power demand of the receiving side should be considered, divided by the voltage rating in the supply side (e.g. for $P=100\text{kW}$, $V=400\text{V}$, $I = 100,000/400 = 250\text{A}$. In this case two parallel cables max rated to 125A could be used. Extensions could be permitted o)

Installation

Segregation: High voltage cables are not to be installed on the same cable tray for the cables operating at the nominal system voltage of 1 kV or less.

Installation Arrangements: High voltage cables are to be installed on cable trays or equivalent when they are provided with a continuous metallic sheath or armour which is effectively bonded to earth; otherwise, they are to be installed for their entire length in metallic casings effectively bonded to earth.

When used with a dedicated Cable Management Systems (CMS) the shore power cables must be of the adequate length to the cable reel available. When stowed and secured along with the CMS, the shore power cable should not be loose or stored incorrectly.

Marking: Shore Power cables are to be readily identifiable by suitable marking.

3.11.3 Cable Management System

The Cable Management System (CMS) is one of the most important and challenging elements of SSE installations. There is currently no single design CMS and even for different ship types the existing standardised references follow different configurations. The CMS has a fundamental role to ensure the physical interface between shore and ship sides. This role is of particular relevance in view of the size of the power cables, their weight per unit length and the need to ensure time-effective and safe operation.

Below, a list of functional and general requirements is presented which is relevant to all CMS:

Physical Connection	<ol style="list-style-type: none">1. The CMS, (composed of cable reels, crane, and other associated equipment) should enable the connection of SSE connection cables between the shore connection switchboard and the ship receiving switchboard, being suitable for the different places where the vessel intends to connect, accommodating for different environmental conditions, tidal range and other at berth context factors, including consideration for different ship operating profiles.2. The CMS should be arranged to provide an adequate movement compensation (due to ship movement, tidal changes, etc.) and to maintain an optimum length of cable avoiding slack cable or exceeding of tension limits.3. The CMS should ensure that the cable tension does not exceed the permitted design value. To this end the CMS should be equipped with a device (e.g. limit switches), independent of its control system, to monitor maximum cable tension and deployed cable length.4. Consideration may be given to equivalent alternative measures (automatic break-away release, connectors with shear bolts and pilot lines, connection with ship/shore emergency shutdown system, etc.).
Alarms	<ol style="list-style-type: none">1. The detection of excessive tension in the cable should activate<ul style="list-style-type: none">• an alarm (1st stage) – alarm to be displayed by rate of tension increase, well before the maximum tension limit is reached.• an emergency shutdown (ESD) (2nd stage) – to be set2. Where the cable length may vary, the remaining cable length shall be monitored, and threshold limits are to be arranged in two stages<ul style="list-style-type: none">• an alarm (1st stage) – alarm.• an emergency shutdown (ESD) (2nd stage) – to be set3. Alarms should be provided for all different CMS relevant/critical technical features, especially those involving electrical equipment parameters, temperatures (where relevant), detection of mechanical component failures.4. As a minimum, alarms should be displayed in the equipment, and remotely.

Safety

1. CMS should be equipped with warning notices to highlight the presence of high voltage, moving parts, obstacles, risks of fall, etc. This should include visual warning notice, with visual and audible signals considered whenever motion of the system is taking place.
2. The CMS, and all associated equipment, including junction boxes, cables, connectors, and ancillary equipment, should be physically protected against mechanical damages, considering the different operational context at berth, including traffic, cargo handling, ramp and platform movements. As a minimum the following hazardous scenarios should be covered, with protection provided by design:
 - a. Vehicle collision
 - b. Breaking mooring lines
 - c. Side loads of mooring lines during
 - d. Fallen object from Ship side
 - e. Collision of ship's for structure whilst approaching berth/pier.
3. Power, control and monitoring cables are to be at least of a flame-retardant type in accordance with the requirements given in IEC 60332-1-2. The outer sheath is to be oil-resistant and resistant to sea air, seawater, solar radiation (UV) and not hygroscopic.
4. The behaviour and integrity of the CMS under breakaway condition should be demonstrated. The time necessary to disconnect the shore connection system should be recorded.
5. Address the risk of submersion by prevention or through the equipment's design. Cable saddles in the water should be avoided. When such avoidance is not possible/feasible
6. The ship and shore HV circuit-breakers shall be arranged to open all insulated poles in the event of a damaging current unbalance between multiple phase conductors (separate, parallel power cables and connectors). Protective devices to satisfy this requirement shall be installed ashore to isolate the connection in the event of damaging unbalance detection.

Design

1. Design of the Cable Management System should take into consideration all expected forces acting on the structural elements of the CMS. Loads should comprise operation of all cables necessary for shore power supply and CMS control.
2. Foundations for CMS should be designed with adequate consideration for reactions,
3. Power, control and monitoring may be based on a single cable or multiple cables suitably arranged so as to facilitate motion of the whole system, as applicable.
4. Maintain the bending radius of cables above the minimum bending radius recommended by the manufacturer during deployment, in steady-state operation and when stowed;
5. CMS should be capable of retrieving and stowing the cables once operations are complete.
6. Where the cable management system employs cable reel(s), the HVSC system rated power shall be based on the operating condition with the maximum number of wraps of cable stowed on the reel that is encountered during normal operations. Where applicable, the cable sizing shall include appropriate de-rating factors.
7. Slip ring units shall be tested in accordance with IEC 62271-200 (excluding non-applicable tests) for the items listed in IEC/IEEE 80005-1. Applicable only to HV.

Equipotential
bond
monitoring

The equipotential bond monitoring device, where utilized, shall be installed either ashore or onboard where the cable management system is installed. Equipotential bond monitoring termination devices, where utilized, shall be installed on the other side.

NOTE: Despite the non-mandatory nature of Equipotential Bonding Monitoring in IEC/IEEE80005-1 this is an important functional element for Safety. This should be of particular relevance where bonding is achieved through temporary clamping, where resistance in the connection zone may be higher.

Different configurations for the Cable Management System are possible, depending on the location of the cable reel and on the responsibility for supplying the shore connection cable. HV and LV shore connection CMS configurations are detailed in the Annexes of IEC/IEEE 80005-1 and 3, respectively.

The figure below includes diagram representations of the possible CMS arrangements.

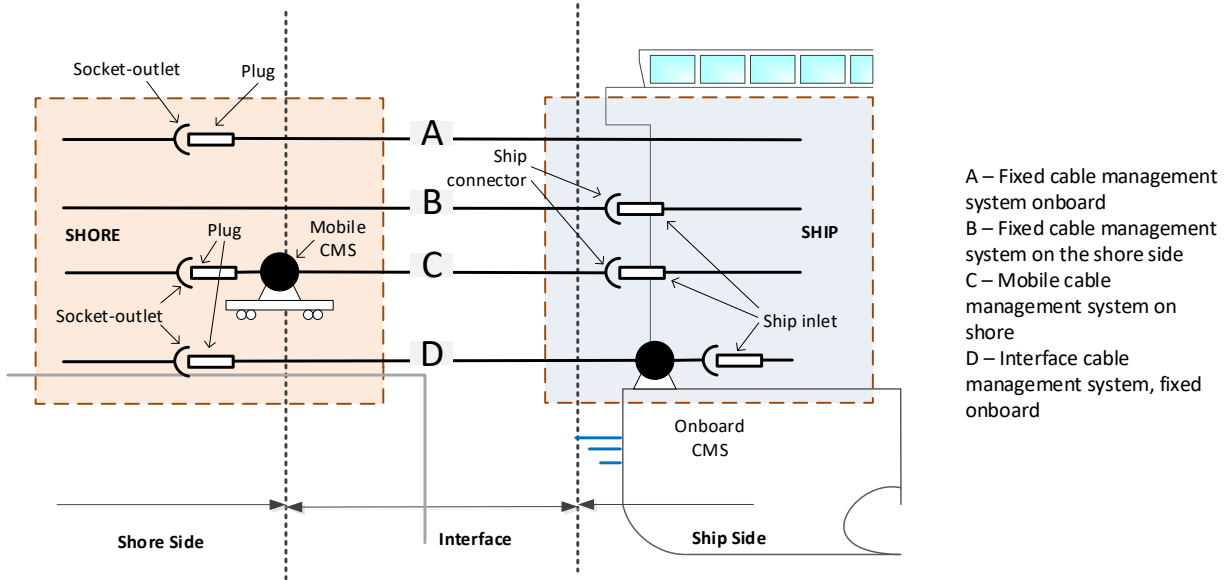

Figure 3.102 - Diagram representations of the possible CMS arrangements

Source: EMSA

Different examples of Cable Management Systems are presented below in Figure 3.103 to Figure 3.123 giving illustration of the variety of architectures that can be considered, typically depending on the ship type and requirements



Figure 3.103 - OPS mobile CMS – HVSC for cruise ships at Port of Hamburg.

All cable connections are grouped in one mechanical arm.

Source: Hamburg Port Authority



Figure 3.104 – OPS mobile CMS – compensation for tidal movement of the vessel is a fundamental functional role of all CMS equipment.

Source: Hamburg Port Authority



Figure 3.105 – OPS mobile CMS – HV connection of the mobile CMS to a trenching flexible cable tray which runs along the length of the berth.

Source: Hamburg Port Authority



Figure 3.106 – OPS mobile CMS.

Trenched flexible cable tray running along the length of the berth. This allows the cable reel mounted onto the mobile CMS to be minima t as can be seen in images 2.64 and 2.65, above.

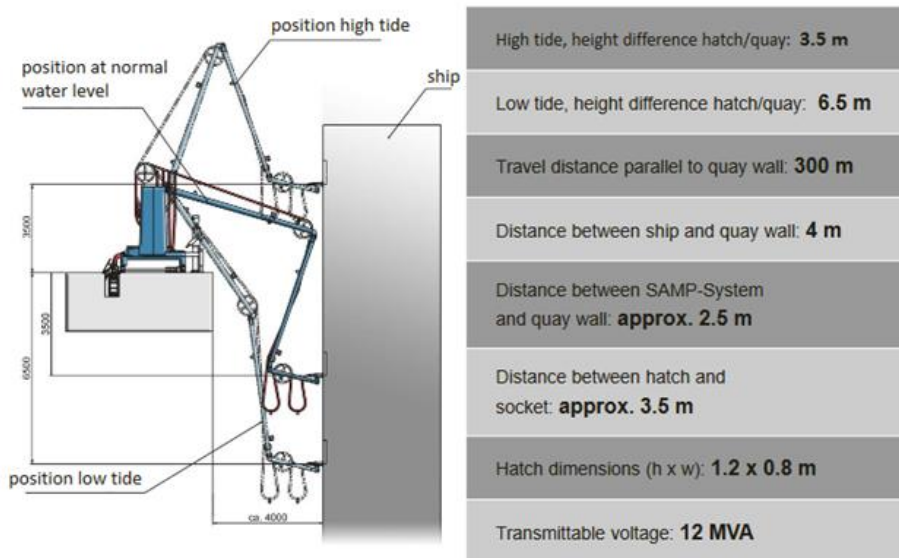

Figure 3.107 – OPS mobile CMS – representation of the flexibility provided by the mechanical articulated arm, able to move along the tidal range for the ship at berth.

Source: Stemmann-Technik GmbH



Figure 3.108 – OPS mobile CMS – Port of Shanghai.

The mechanical articulated arm holds the connector hanger (with 4HV connectors + 1 Neutral + Pilot wires (if not incorporated in HV connector)).

Source: Wabtec Corporation



Figure 3.109 – OPS mobile CMS – Port of Shanghai.

The connector hanger positions the whole set of connectors in the proximity of the OPS station onboard the cruise ship. A mobile CMS provides for the necessary flexibility for different onboard OPS station positions.

Source: Wabtec Corporation



Figure 3.110 and Figure 3.111 – OPS mobile CMS – Port of Shanghai.

Unlike the mobile CMS installed in the Port of Hamburg, the Shanghai version is not provided with a trench for the HV connection. Instead, as it can be seen in the picture, the feeding cables are stored in a cable reel. They are connected to an OPS vault first and then the mobile CMS takes the HV connectors to the “extra-mile” allowing for flexibility in the OPS service to different ships. Having HV cable laying on the berth floor requires attention and area restriction during operation.

Source: Wabtec Corporation



Figure 3.112 and Figure 3.113 – OPS fixed CMS – Port of San Diego – crane assisted handling of the HV feeders (including neutral and communications).

The crane is in the proximity of the onboard OPS station. On the shore side the socket-outlet/plug arrangement can be seen in the red box to the left. Margin for different ships is reduced.

Source: Watts Marine LLC



Figure 3.114 – OPS fixed CMS – RO-Pax HVSC supported by crane.

To be noted the single cable, in accordance with IEC/IEEE 80005-1 Annex-B. To be noted also the coexistence of 2 fixed CMS close to each other. This reflects the need to provide power to ships with different receiving point locations.

Source: Tallink



Figure 3.115 – OPS fixed CMS – RO-Pax HVSC supported by hydraulic articulated mechanical arm.

To be noted the single cable, in accordance with IEC/IEEE 80005-1 Annex-B. Saddle in the cable should not represent additional load in the connection. It is important to manage cable length, so connection is not physically stressed.

Source: Autoridad Portuaria de Santa Cruz de Tenerife

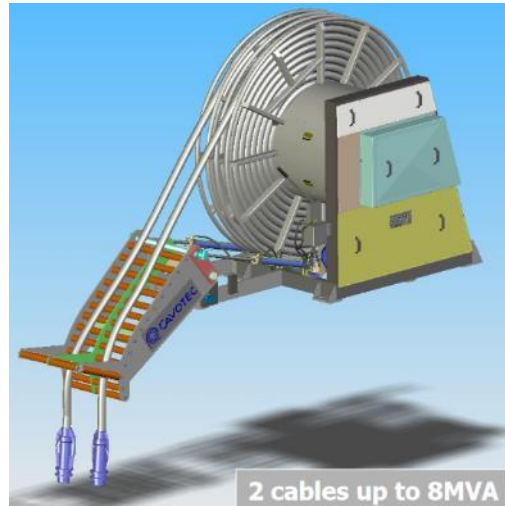
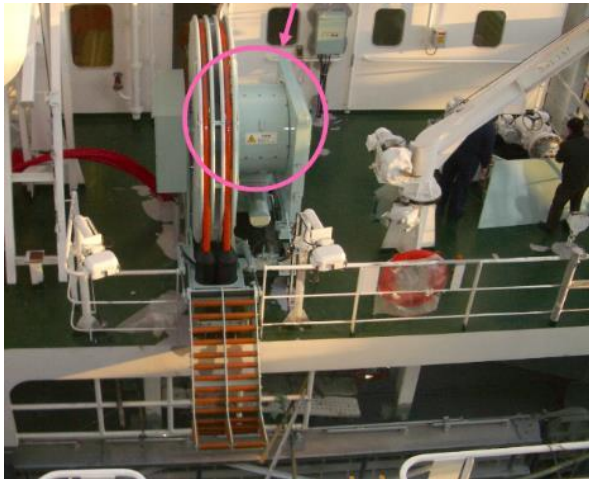

Figure 3.116 and Figure 3.117– Onboard OPS fixed CMS - containership HVSC cable reel onboard.

Responsibility to provide the cable for connection is on the ship side. A cable handler with rollers facilitates the delivery of the cables to the shore-side for connection to a HV connection pit.

Source of 2.78: ABB

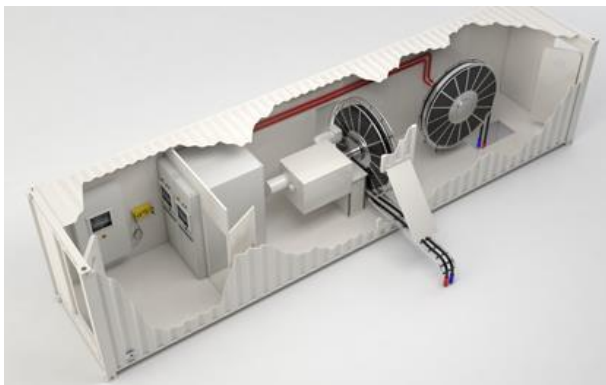

Figure 3.118 and Figure 3.119– Other example of onboard OPS fixed CMS - containership HVSC cable reel onboard.

Containerized solution is here presented for HVSC onboard containerships. 2 cable reels store the cabling for shore and onboard connection. This gives flexibility to container vessels which may opt for port or starboard connection making use of modularity. Retrofitting is also made easier in this way.

Source: Wärtsilä

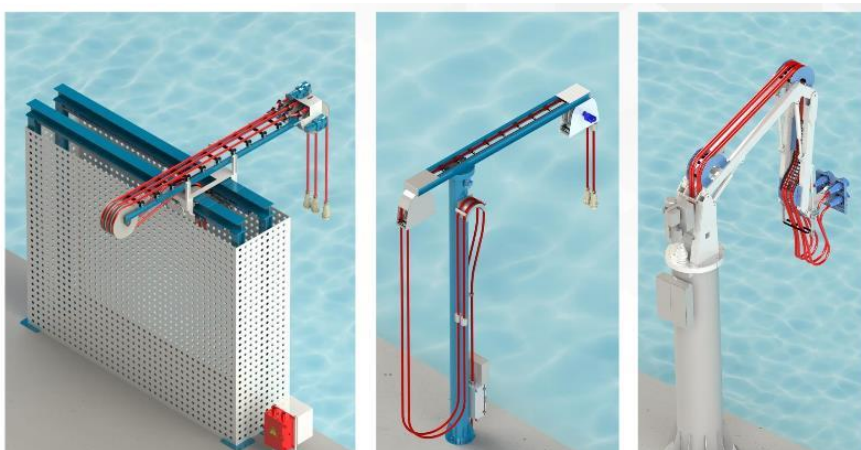

Figure 3.120 – Three different CMS, electromechanically assisted, located at the shore side.

Whilst being all three fixed it is possible to understand the level of different flexibility provided with different possible degrees of freedom for connection.

Source: Stemmann-Technik GmbH



Figure 3.121 and Figure 3.122– To provide for longitudinal flexibility at berth, a mobile socket-outlet junction box can be considered in order to allow for cables to be provided by the ship-side at the most convenient location.

Source: Stemmann-Technik GmbH

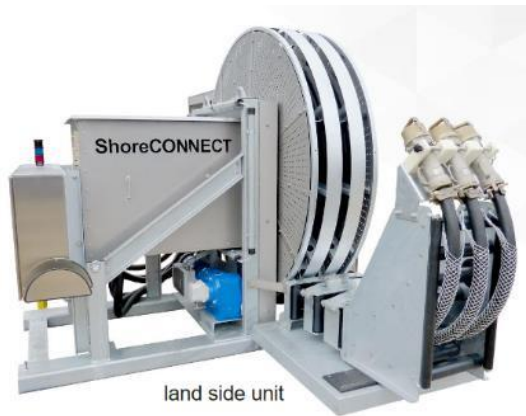

Figure 3.123 – Fixed CMS, for installation on the shore side, with cable reel and 3 power cable lines presented.

Source: Wabtec Corporation

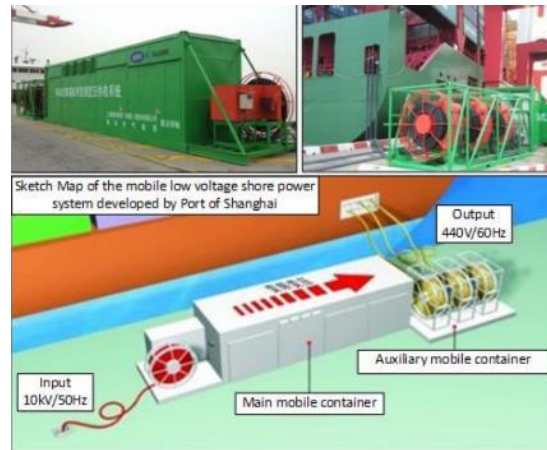

Figure 3.124 – Adapting at berth local mobile transformers for LV supply.

Where HV energy at berth exists but the ship can only receive LV (e.g., 440 V) it is possible to adapt local mobile transformers such as the ones in the picture, allowing for flexibility for less power demanding ships.

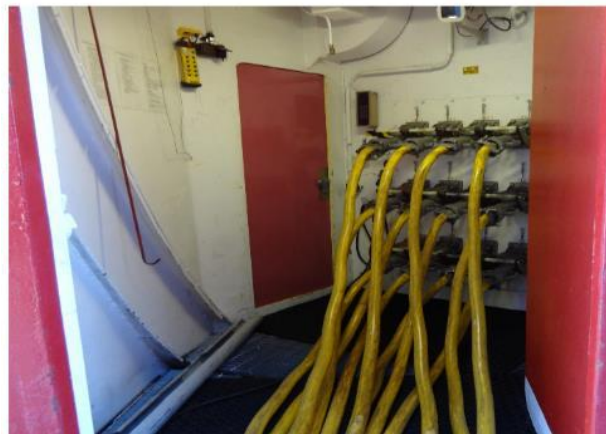

Figure 3.125 and Figure 3.126– Low Voltage OPS – Supply of 4MW in RO-Pax terminal - 12 LV 400V power cables.

The use of a High-Voltage connection would allow the 12 cables presented to be replaced by only one cable, rated 6.6kV. The operational advantages are obvious, favouring adoption of High Voltage connection as the preferred option.

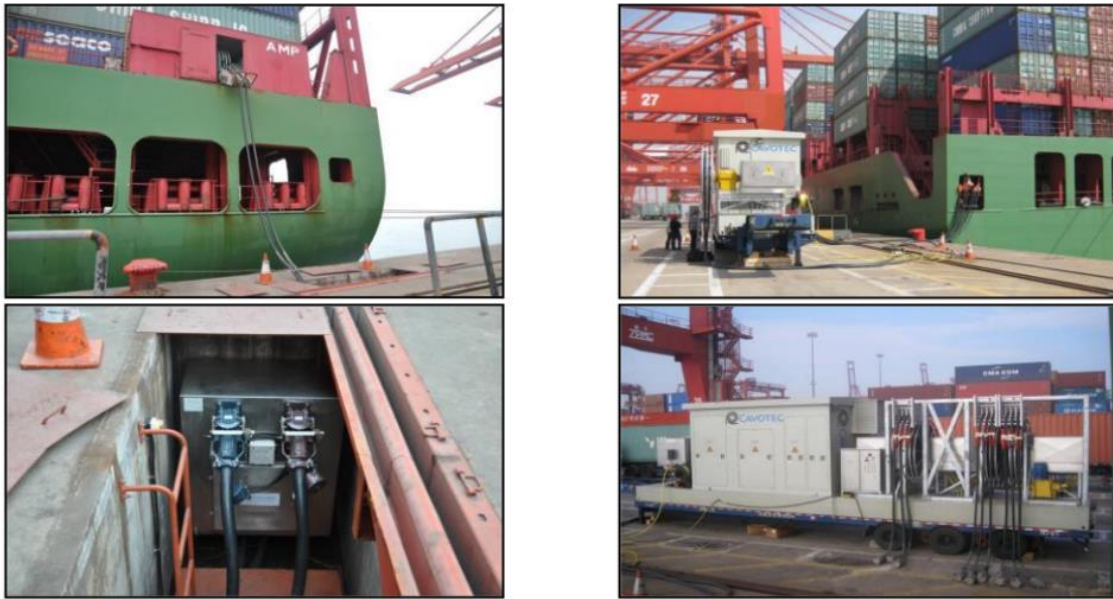

Figure 3.127 and Figure 3.128 - Two different options for shore-power supply to containerships.

To the left a HVSC, with Cable Management System onboard (in containerized station). Plugs are connected to the socket-outlets in a HVSC pit/junction-box. To the right, with a LVSC, it can be seen how the number of cables increases significantly.

3.11.4 Connectors

Connectors are standardised for all ranges of OPS voltage ratings, both for Low Voltage and High Voltage connections. The table below indicates the correspondence of the different standards that shore-power connectors should observe in order to ensure interconnectivity and electrical safety:

Table 3.25 – Shore Power Connector – Standards for interconnectivity.

Shore Connection type	OPS Standard	Relevant Standard for connectors	
		General, functional, electrical safety and dimensional requirements.	Ship types
HVSC	IEC/IEEE 80005-1	IEC 62613-1	Cruise ships, RO-Pax, Tankers, Containerships, LNG carriers
LVSC	IEC/IEEE 80005-3	IEC 60309-1 for general requirements IEC 60309-5 for technical requirements and geometry/ dimensions	Service Ships (OSV, other), Containerships, Tankers Rating 690 V, 50/60 Hz, 350 A rated standard
	(Otherwise not covered in IEC80005-3), in particular as applicable to small craft and pleasure boats, house boats EN 15869-1:2019 IEC 60364-7-709:2007 +AMD1:2012 CSV	IEC 60309-1,2	All ships, inland waterway vessels, pleasure craft, otherwise not covered by IEC/IEEE 80005-3, with low power demand and rating requirements in the range <i>voltage:</i> <50 to 690 Volt AC and 50 to 250 Volt DC; <i>current:</i> 16 to 125 A;

A. Alternative Arrangements

For LVSC and HVSC, the contact assignment of connectors shall be according to applicable ship annexes in both IEC/IEEE 80005-1 and 80005-3. Modifications to the standards connectors prescribed by should not be considered unless an electrical risk assessment is provided and accepted at the light of a specific application of proprietary connection system where a ship operates on dedicated routes. This is pointed also in the introductory text of IEC/IEEE 80005-1, from where it can be transcribed:

*Clauses 1 to 12 are intended for application to all HVSC systems. They intend to address mainly the safety and effectiveness of HVSC systems with a minimum level of requirements that would standardise on one solution. This document includes the requirement to complete a detailed compatibility assessment for each combination of ship and shore supply prior to a given ship arriving to connect to a given shore supply for the first time. **This does not preclude the use of this document e.g. for safety purposes, such as for proprietary connection systems where a ship operates on dedicated routes***

The part underlined in bold can be considered as a flexibility clause for possible different connectivity arrangements which, provided all relevant functional and safety requirements are met, can be considered for specific applications.

Whilst not being the ideal situation this can certainly be the case in the event of innovation or any other type of proprietary solution, provided the ship is operated in a fixed route and/or both ship and shore side are owned by same operator.

Under all circumstances the use of a different connectivity arrangement for shore-power supply, at either HVSC or LVSC arrangement, should be preceded from a technical feasibility study and accompanying electrical risk assessment.

B. HV vs LV connection

The level of specificity of HV connections is higher than for the case of LV. With HVSC the Annexes in IEC/IEEE 80005-1, and IEC 62613-1, prescribe specific different geometries for different ship types. The same is not the case with IEC/IEEE 80005-2, for LV, where one type of plug, socket-outlet, ship inlet and ship connector shall be used for all types of ships covered by the standard, conforming with IEC 60309-1 and IEC 60309-5.

This is an important aspect to be considered by ports when designing HVSC infrastructure. Construction of HV solution will always have to be “terminal-specific” where the installation applies to the specific ship types operating in that terminal.

C. General/safety

Handling of connectors shall be possible only when the associated earthing switch is closed. Socket-outlets and inlets are to be interlocked with the earth switch so that plugs or connectors cannot be inserted or withdrawn without the earthing switch in closed position. The earthing contacts are to make contact before the power contacts do when inserting a plug.

Connections shall be made in areas where personnel will be protected in the event of an arc flash as a result of an internal fault in the connectors by barrier and access control measures. These areas should be well identified, provided with physical barriers and supported by access control procedures.

Support arrangements are required so that the weight of connected cable is not borne by any plug or ship connector termination or connection.

The plug and socket-outlet arrangement are to be fitted with a mechanical-securing device that locks the connection in engaged position.

The plugs and socket-outlets are to be designed so that an incorrect connection cannot be made.

Plugs are to be designed so that no strain is transmitted to the terminals, contacts and cables.

D. Pilot Contacts

Each connector shall be fitted with pilot contacts for continuity verification of the safety circuit (See Section 18 for safety circuit descriptions and examples). For single connector connections, a minimum of five pilots is required. If more than one cable is installed, an interlock shall be used so that no cable remains unused.

Contact sequence shall be in the following order:

- A. connection:
 - 1) earth contact
 - 2) power contacts
 - 3) pilot contacts
- B. disconnection:
 - 5) pilot contacts
 - 6) power contacts
 - 7) earth contact

Pilot contact connections shall open before the necessary degree of protection is no longer achieved during the removal of an HV-plug or connector. Pilot contacts are part of the safety circuit.

This smaller pins in are shorter than the others, designed to 'make' after all the other pins when connecting a plug and socket, and to 'break' first when disconnecting. It is used to switch off the load. This is useful as disconnecting under load will cause arcing which may cause damage to both the plug and socket, and risk injury to the user.

E. Earth contact

The current-carrying capacity of the earth contact shall be at least equal to the rated current of the other main contacts.

F. Examples

Below the shore connection for HVSC of Containerships is presented as an example of the Plug and Socket connection arrangement, interlocked by Pilot Contactors.

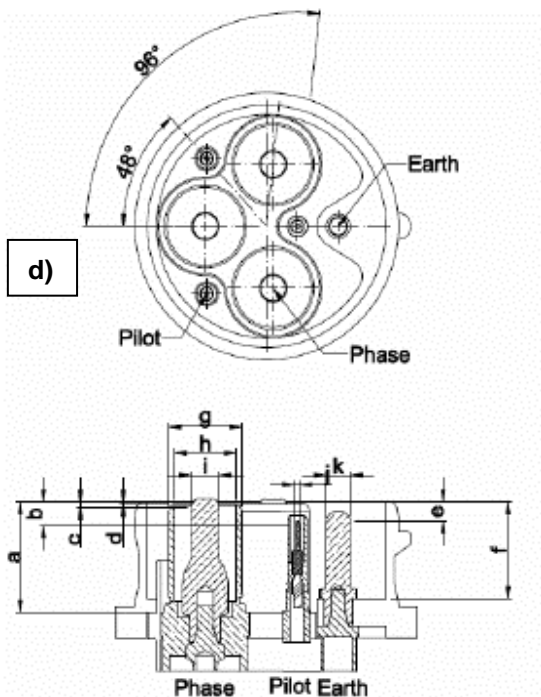
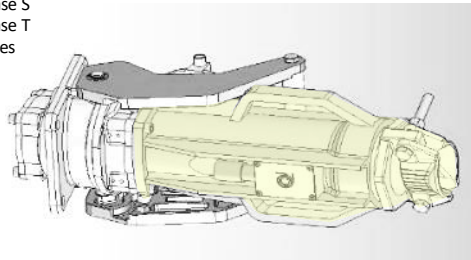
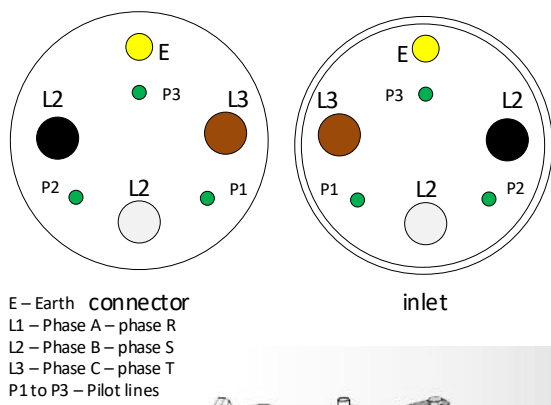
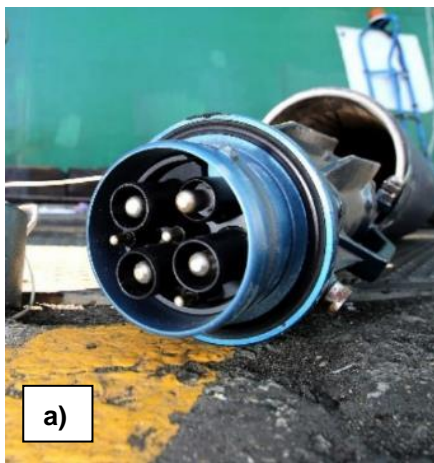

Symbol	Name	Dimension
a	Insulator depth	64
b	Contact pilot	13,8
c	Contact phase	3,4
d	Top insulator	1,4
e	Contact earth	11,1
f	Tounge depth	56
g	Insulator outside Ø	42,5
h	Insulator inside Ø	36,5
i	Phase Ø	16
j	Pilot Ø	3
k	Earth Ø	14
l	Partition phases Ø	72
m	Partition pilots Ø	84
n	Partition earth Ø	105
o	Insulator Ø	119,6
p	Plug inside Ø	140
q	Plug outside Ø	154,5
r	Plug outside + nose	162
s	Partition pilot Ø	36

Figure 3.129 – a) HVSC plug – containerships (IEC/IEEE80005-1 Annex D, IEC 62613-2:2016, Annex II); b) diagram of the connector face and inlet face for the same connector, identifying the earth, phases and pilot contacts; c) HVSC containerships – closed and secure plug and socket outlet; d) Plug and socket, interlock by Pilot Contactor (ABS HV Shore Power Guidelines)

Sources: a) Port of Los Angeles; b) IEC; c) and d) Cavotec SA



Figure 3.130– Ship side HVSC connector-inlet arrangement onboard a cruise ship including 4 parallel power cables + one neutral.

Source: Port of Seattle



Figure 3.131 – HVSC plug and socket outlet - containerships.

G. Connection options

The most common connection options are:

- 1-phase 230 V, 10–16 A
- 3-phase 400 V, 16–32 A
- 3-phase 400 V, 63 A
- 3-phase 400 V, 125 A
- 3-phase 400 V, higher than 125 A, or parallel cables
- 3-phase 690 V, 350A, or parallel cables
- 3-phase 6.6/11kV (high voltage).

H. IEC 60309 classification

IEC 60309 is the relevant standard series for the large share of low-voltage

Each individual socket can only be used for a specific current, voltage and frequency. The protective earth sleeve takes up in each normalized case a specific position - clock position - in relation to the guide track. Standardised ballasts are color-coded according to the dial, where the clock positions (1 h to 12 h) corresponds to the location of the earth sleeve in the sockets, seen from the front, with the guide track always placed in the clock position 6 h. The devices are in 2-, 3-, and 4-pole design with rated currents 16 A, 32 A, 63 A and 125 A and for voltages 50 V to 690 V at 50 and 60 Hz.

There are many types of IEC 60309 sockets, outlets, plugs, connectors and application inlets. They differ with respect to:

- voltage: <50 to 690 Volt AC and 50 to 250 Volt DC
- current: 16 to 125 A
- frequency: 50 or 60 Hz

Connections are either splash-proof (IP44), or waterproof (IP67). For all shore power applications IP67 is the mandatory water protection index.

All plugs and sockets have a protective earth (E) connection.

Three-phase devices exist with and without neutral connection.

Plugs have round pins, arranged in a circle. The diameter of the earth pin (E) is always 2 mm larger than the other pins. Male plugs and appliance inlets have a circular shroud. Sockets and connector plugs have matching recess.

Plugs and male inlets have a key (see image below). Sockets and connectors have a matching, invariably down facing keyway.

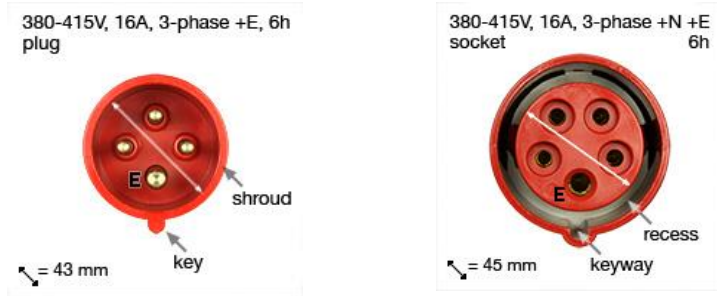

Figure 3.132 – Example of IEC 60.

The position of the (large) earth pin can be in one of 12 positions, described as clock positions (1 -12 hour), see image below.

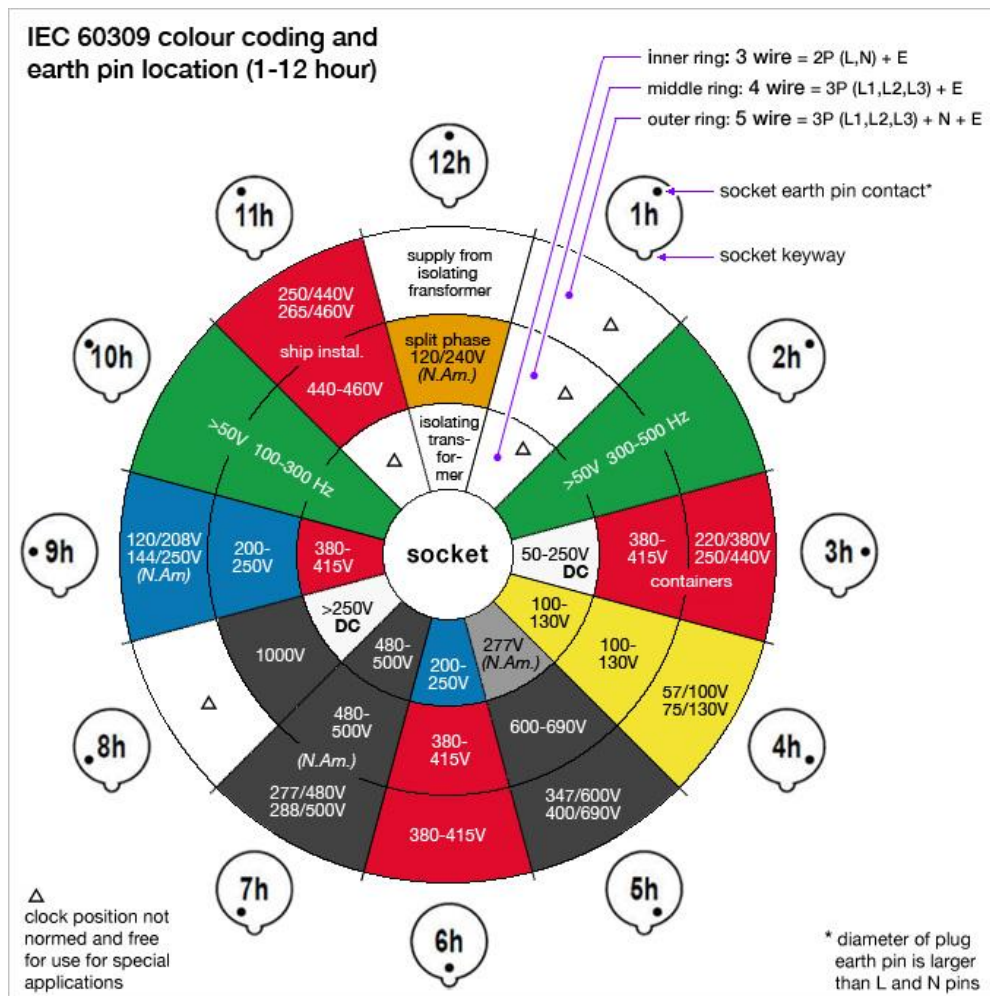

Figure 3.133 – IEC60309 colour coding and earth pin location – “clock-chart”.

For each type of plug only one matching socket exists. This ensures that connection is only possible when voltage, current, frequency and number of pins/contacts match.

Various configurations arise from differences in:

1. number of pins: 3, 4 or 5 (special variants with <5 pins exist),
2. earth pin clock position and
3. diameter of pin shroud/ socket recess.

The clock scheme shows that pin number and earth pin clock position results in 36 different configurations. Differences in diameter adds many more.

I. Fibre-optic connection

Where required by a ship-specific annex, an optical fibre socket, shall be installed on the connector or plug. Fibre-optic cable, terminated with a fibre-optic plug, shall be mounted on the stationary side, adjacent to the three-phase inlet or socket outlet. This shall be in accordance with IEC/IEEE 80005-1, section 7.3.4.

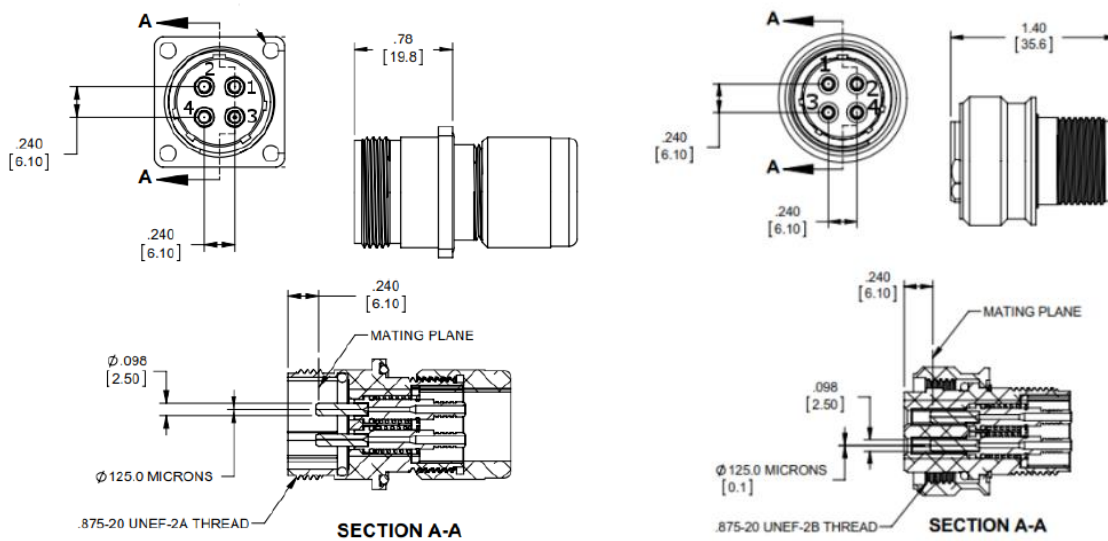

Fibre-O

Figure 3.134 – IEC/IEEE 80005-1 Fibre-optic connection.

Nomenclature: Cylindrical Connectors

Basic Components

1. Shell (Houses Inserts & Contacts)
2. Insert (Dielectric Contact Insulator) Pin or Socket
3. Contact (Wire End Termination) (Electrical Engagement)
4. Coupling Nut
5. Accessories (Wire Seals, Cable Seals, Wire Support, etc.)

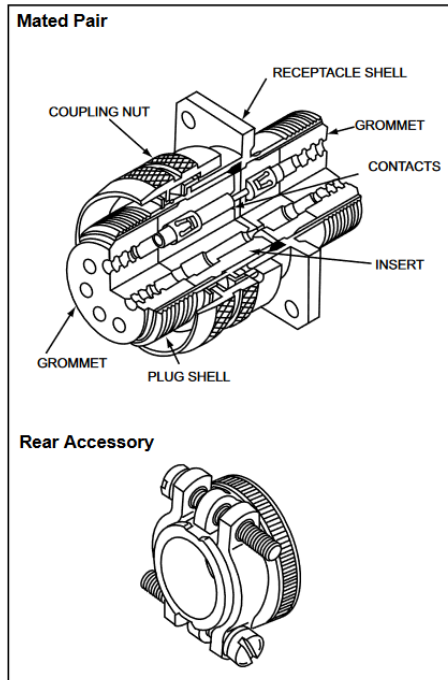
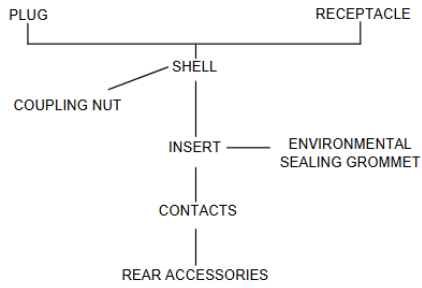

Figure 3.135 – Nomenclature for Fibre-Optic cylindrical connections.

Source: Amphenol Corporation Reference Guide to Cylindrical Connectors

References for Part 1

- [1] ENTEC, European Commission DG-ENV Service Contract on Ship Emissions: Assignment, Abatement and Market-based Instruments - Task 2 Shore-side Electricity, 2005.
- [2] EC, COMMISSION RECOMMENDATION of 8 May 2006 on the promotion of shore-side electricity for use by ships at berth in Community ports (Text with EEA relevance) (2006/339/EC), EC, 2006.
- [3] EU, Directive 2014/94/EU of the European Parliament and of the Council of 22 October 2014 on the deployment of alternative fuels infrastructure, 2014.
- [4] EC, "Regulation (EU) 2017/352 of the European Parliament and of the Council of 15 February 2017 establishing a framework for the provision of port services and common rules on the financial transparency of ports," 2017.
- [5] IMO, Draft Interim Guidelines On Safe Operation Of Onshore Power Supply (OPS) Service in Port for Ships Engaged on International Voyages, IMO, 2020.
- [6] IEC/IEEE, IEC/IEEE 80005-2 Utility connections in port – Part 2: High and low voltage shore connection systems – Data communication for monitoring and control, IEC/IEEE, 2016.
- [7] D. R. -. L. Grandidier, Shore Connection Technology - Environmental Benefits and Best Practices - SE July 2012, Schneider Electric, 2012.
- [8] IEC/IEEE, IEC/IEEE 80005-1 - Utility connections in port – Part 1: High voltage shore connection (HVSC) systems – General requirements, IEC/IEEE, 2019.
- [9] IEC/IEEE, IEC/IEEE DIS 80005-3 - Utility connections in port — Part 3 Low voltage shore connection (LVSC) systems — General requirements, IEC/IEEE.
- [10] EEA, Overview of electricity production and use in Europe, 2018.
- [11] IEEE, IEEE Std 1100-1992, "Recommended Practice for Powering and Grounding of Sensitive Electronic Equipment.", IEEE, 1992.
- [12] ABB , Shore connection solutions - shaping a sustainable world - MARINE & PORTS | SERVICE, ABB, 2019.
- [13] E. Csanyi, Reactive power and PF correction @ <https://electrical-engineering-portal.com/>, EEP, 2019.
- [14] Schneider Electric, Guide to energy measurement applications and standards - White Paper Number 998-19721656_GMA-US, Schneider Electric, 2016.
- [15] Schneider Electric, Electrical Installation Guide, 2018.
- [16] ABB, Shore-to-ship power Solutions - Static Frequency Conversion Platforms, ABB, 2019.
- [17] "<https://www.georator.com/frequency-conversion-guide.html>," 2019. [Online]. [Accessed 21 02 2021].
- [18] D. Tarnapowicz and S. German-Galkin, "Analysis of the Topology of Shore-to-Ship Systems - Power Electronic Connection of Ships with Land," in *New Trends in Production Engineering*, 2018.
- [19] DNV-GL, Recommended practice — DNVGL-RP-0043. Edition September 2017 - Safety, operation and performance of grid-connected energy storage systems, DNV-GL, 2017.
- [20] Battery, <https://batteryuniversity.com>, 2020.
- [21] D. M. M. Ali, "Hydrogen Energy Storage," in *Energy Storage Devices*, IntechOpen, 2019.
- [22] DNVGL, Rules for classification: Ships — RU-SHIP Pt.6 Ch.7. Edition July 2019, 2019.
- [23] IEC, IEC 60079-10-1 (2015). Explosive atmospheres – Part 10-1: Classification of areas - Explosive gas atmospheres., IEC, 2015.
- [24] EC, EU general risk assessment methodology (Action 5 of Multi-Annual Action Plan for the surveillance of products in the EU (COM (2013)76) – Document 2015-IMP-MSG-15 - 16 October 2015, 2015.
- [25] EC, Directive 1999/92/EC - ATEX of the European Parliament and of the Council of 16 December 1999 on minimum requirements for improving the safety and health protection of workers potentially at risk from explosive atmospheres, 1999.
- [26] API, API RP-505. 1997, Recommended practice for classification of locations at petroleum facilities classified as Class I, Zone 0, Zone 1 and Zone 2. Washington, D.C. API., 1997.

- [27] API, API RP-500. 1997. Recommended practice for classification of locations for electrical installations at petroleum facilities classified as Class 1, Division 1 and Division 2. Washington. D.C: API, 1997.
- [28] EC, C(2019) 5960 final COMMISSION DELEGATED REGULATION (EU) supplementing and amending Directive 2014/94/EU of the European Parliament and of the Council as regards recharging points for L-category motor vehicles, shore-side electricity supply for inland water, EC, 2019.
- [29] CESA, MEPC 69/5/8 - Promoting the use of onshore power supply - Submission to MEPC69, IMO, 2016.
- [30] EPA, Shore Power Technology Assessment at US Ports - EPA-420-R-17-004, United States Environmental Protection Agency, 2017.
- [31] CARB, Technical support document: Initial statement of reasons for the proposed rulemaking - Regulations to reduce emissions from diesel auxiliary engines on oceangoing vessels while at-berth at a California port, Sacramento, CA: California Air Resources Board, 2007.
- [32] CARB, Initial statement of reasons for proposed rulemaking - Proposed amendments to the regulations "fuel sulfur and other operational requirements for ocean-going vessels within California waters and 24 nautical miles of the California baseline, Sacramento, CA: California Air Resources Board, 2011.
- [33] C.-C. & W. C.-M. Chang, Evaluating the effects of green port policy: Case study of Kaohsiung harbor in Taiwan, Transportation Research Part D: Transport and Environment, 17(3), 185-189, 2012.
- [34] J. J. & C. B. Corbett, Clearing the air: Would shoreside power reduce air pollution emissions from cruise ships calling on the Port of Charleston, SC?, Pittsford, NY: Energy and Environmental Research Associates, 2013.
- [35] E. A. Z. B. A. D. J. J. A. & S. A. Sciberras, Cold ironing and onshore generation for airborne emission reductions in ports. Proceedings of the Institution of Mechanical Engineers, Part M: Journal of Engineering for the Maritime Environment, 2014.
- [36] IEC, IEC 60034 (all parts), Rotating electrical machines, IEC.
- [37] IEC, IEC 60050-151:2001, International Electrotechnical Vocabulary – Part 151: Electrical and magnetic devices, IEC, 2001.
- [38] IEC, IEC 60092-350:2008, Electrical installations in ships – Part 350: General construction and test methods of power, control and instrumentation cables for shipboard and offshore applications, IEC, 2008.
- [39] IEC, IEC 60092-353, Electrical installations in ships – Part 353: Power cables for rated voltages 1 kV and 3 kV, IEC, 2014.
- [40] IEC, IEC 60092-354:2014, Electrical installations in ships – Part 354: Single- and three-core power cables with extruded solid insulation for rated voltages 6 kV ($U_m = 7,2$ kV) up to 30 kV ($U_m = 36$ kV), IEC, 2014.
- [41] IEC, IEC 60092-360, Electrical installations in ships – Part 360: Insulating and sheathing materials for shipboard and offshore units, power, control, instrumentation and telecommunication cables, IEC, 2014.
- [42] IEC, IEC 60092-376, Electrical installations in ships – Part 376: Cables for control and instrumentation circuits 150/250 V (300 V), IEC, 2017.
- [43] IEC, IEC 60092-502, Electrical installations in ships – Part 502: Tankers – Special features, IEC, 1999.
- [44] IEC, IEC 60092-509, Electrical installations in ships – Part 509: Operation of electrical installations, IEC, 2011.
- [45] IEC, IEC 60228:2004, Conductors of insulated cables, IEC, 2004.
- [46] IEC, IEC 60793-2, Optical fibres – Part 2: Product specifications – General, IEC, 2019.
- [47] IEC, IEC 60793-2-10, Optical fibres – Part 2-10: Product specifications – Sectional specification for category A1 multimode fibres, IEC, 2019.
- [48] Hitachi/ ABB, <https://www.hitachiabb-powergrids.com/references/substation-automation/uk-national-grid-rewards-exceptional-performance-with-contract-e>.
- [49] EATON Technical, Power factor correction: a guide for the plant engineer - Technical Data SA02607001E, EATON, 2014.

- [50] IRS, Guidelines on High Voltage Shore Connection Systems for Ships 2020, IRS, 2020.
- [51] BV, Rule Note NR 557 DT R00 E - High Voltage Shore Connection, BV, 2010.
- [52] I. Fazlagic and P. Ericsson, "Shore-side power supply: a feasibility study and a technical solution for an on-shore electrical infrastructure to supply vessels with electric power while in port - MSc Electric Power Engineering,," Chalmers University of Technology, Göteborg, Sweden, 2008.
- [53] A. Innes and J. Monios, "Identifying The Unique Challenges of Installing Cold Ironing at Small and Medium Ports – The Case Of Aberdeen," *Transportation Research Part D: Transport and Environment*. 62: 298–313., 2018.

Links for figures in Part 1

- Figure 3.15 - <https://www.conrad.com/p/janitza-umg-512-pro-power-quality-analyzer-voltage-quality-analyzer-umg-512-pro-1541262> Last accessed in 09/03/2022
- Figure 3.16 - <https://hiokiusa.com/product/power-quality-analyzer-pq3198/> Last accessed in 09/03/2022
- Figure 3.22- <https://www.electricaltechnology.org/>
- Figure 3.23 - <https://electricalfundablog.com/underground-power-cables-architecture/>
- Figure 3.24 - <https://lightingpole.en.made-in-china.com/product/jKNEhOWMAUpr/China-Double-Circuit-Towers-33kv-Transmission-Line-Pole-Tubular-Electric-Galvanized-Steel-Power-Monopole.html> Last accessed in 09/03/2022
- Figure 3.26 - <https://www.centaur.ae/contracting/underground-cabling/> Last accessed in 09/03/2022
- Figure 3.27 - <https://electrical-engineering-portal.com/download-center/books-and-guides/power-substations/underground-power-transmission-lines> Last accessed in 09/03/2022
- Figure 3.28 - <https://www.helixelectric.com/projects/port-of-long-beach-pier-i-shore-to-ship-power-upgrade/> Last accessed in 09/03/2022
- Figure 3.29 - <https://electrical-engineering-portal.com/testing-and-commissioning-of-mvhv-cables> Last accessed in 09/03/2022
- Figure 3.32 - <https://www.electricaltechnology.org/2018/07/mv-hv-cable-termination-joints.html> Last accessed in 09/03/2022
- Figure 3.33 - <http://testingcommissioning.blogspot.com/2014/05/high-voltage-cable-test.html> Last accessed in 09/03/2022
- Figure 3.34 - <https://www.powerandcables.com/>
- Figure 3.35 - <https://www.powerandcables.com/132kv-link-boxes/> Last accessed in 09/03/2022
- Table 3.9 2 - http://www.opossom.com/francais/clients_realisations-edf_monitoring_poste_de_transformation.html Last accessed in 10/03/2022
- Table 3.9 3 - <http://www.transudan.com/ar/product-25-mv---lv-mobile-substations.html> Last accessed in 10/03/2022
- Table 3.9 4 - <https://www.indiamart.com/ultimacomunication/electrical-power-transmission-distribution.html#18468237391> Last accessed in 10/03/2022
- Figure 3.41 - <https://electrical-engineering-portal.com/why-i-prefer-more-busbar-trunking-systems-and-not-cables> Last accessed in 10/03/2022
- Figure 3.42 - <https://electrical-engineering-portal.com/8-important-checks-to-do-before-powering-up-the-dry-type-transformer> Last accessed in 14/03/2022
- Figure 3.43 - <https://electrical-engineering-portal.com/>
- Figure 3.44 - <https://tmc-india.com/dry-type-transformers/> Last accessed in 10/03/2022
- Figure 3.45 - <http://www.toffoligroup.it/emporio/it/cabine-mtbt/150-cabine-di-trasformazione> Last accessed in 10/03/2022
- Figure 3.51 - <https://studylib.net/doc/18867540/anord-iec-product-range---anord-critical-power-inc> Last accessed in 10/03/2022
- Figure 3.52 - <https://www.linkedin.com/pulse/comparative-study-iec-61439-is-8623-user-perspective-dinesh-singh/> Last accessed in 10/03/2022
- Figure 3.53 - <https://www.semanticscholar.org/paper/Power-frequency-withstand-voltage-type-testing-and-Zub%C4%8D%C4%87-Kr%C4%8Dum/2f29cdcb54a4ee2a6d2b21dc3f831b3ce7f9dc65/figure/0> Last accessed in 10/03/2022
- Figure 3.54 - <https://www.ieisrl.it/en/mvkv-distribution-switchboards/> Last accessed in 10/03/2022
- Figure 3.55 - <https://new.abb.com/products/pt-PT/1SDA013705R1/conn-pr212lsiq-ext-ct-rt-s4-s7-p-w> Last accessed in 10/03/2022

Figure 3.56 - <https://persiantco.com/other/high-voltage-switchboard/> Last accessed in 10/03/2022

Table 3.11 Line 2 - https://www.ecplaza.net/products/intelligent-air-circuit-breaker-acb-drawout_3715743 Last accessed in 10/03/2022

Figure 3.61 - <https://electrical-engineering-portal.com/selectivity-incoming-parallel-feeders> Last accessed in 10/03/2022

Figure 3.62 - <https://electrical-engineering-portal.com/the-basics-of-circuit-breaker-tripping-units> Last accessed in 15/03/2022

Figure 3.64 - <https://electrical-engineering-portal.com/the-basics-of-circuit-breaker-tripping-units> Last accessed in 15/03/2022

Figure 3.72 and Figure 3.73 - <https://www.electronics-tutorials.ws/transformer/transformer-basics.html#:~:text=In%20a%20single-phase%20voltage%20transformer%20the%20primary%20is,common%20closed%20magnetic%20iron%20circuit%20called%20the%20%E2%80%9Ccore%E2%80%9D> Last accessed in 14/03/2022

Table 3.17 1 - <http://www.frequencyconverter.net/>

Table 3.17 2 and 3 - <https://circuitglobe.com/>

Table 3.17 4 - https://www.researchgate.net/publication/328374273_Onboard_Battery_Chargers_for_Plug-in_Electric_Vehicles_With_Dual_Functional_Circuit_for_Low-Voltage_Battery_Charging_and_Active_Power_Decoupling

Figure 3.80 - <https://bwissue.com/coffeestory/664289> Last accessed in 14/03/2022

Figure 3.81 - <http://www.intactcontrols.com/product/rotary-frequency-converter/> Last accessed in 14/03/2022

Figure 3.92 - https://www.researchgate.net/figure/Applicable-power-ranges-and-discharge-power-duration-of-different-energy-storage_fig7_320273548 Last accessed in 14/03/2022

Figure 3.106 - https://www.prefectures-regions.gouv.fr/normandie/content/download/89467/574330/file/4_Pr%C3%A9sentation%20ter%20plan%20de%20relance%20HAROPA.pdf Last accessed in 14/03/2022

Figure 3.124 - <https://slidesplayer.com/slide/11276138/> Last accessed in 14/03/2022

Figure 3.127 and Figure 3.1276 - <https://slidesplayer.com/slide/11276138/> Last accessed in 14/03/2022

Figure 3.131 - <https://www.youtube.com/watch?v=S99iCNBJYqc> Last accessed in 14/03/2022

Figure 3.132 and Figure 3.133- <https://www.ize-industries.com/video-details.aspx?categoryid=29&id=5143> Last accessed in 14/03/2022

European Maritime Safety Agency

Praça Europa 4
1249-206 Lisbon, Portugal
Tel +351 21 1209 200
Fax +351 21 1209 210
emsa.europa.eu

